

## Accepted Manuscript

Electromagnetic-based derivation of fractional-order circuit theory

Tomasz P. Stefański, Jacek Gulgowski

PII: S1007-5704(19)30218-7  
DOI: <https://doi.org/10.1016/j.cnsns.2019.104897>  
Article Number: 104897  
Reference: CNSNS 104897

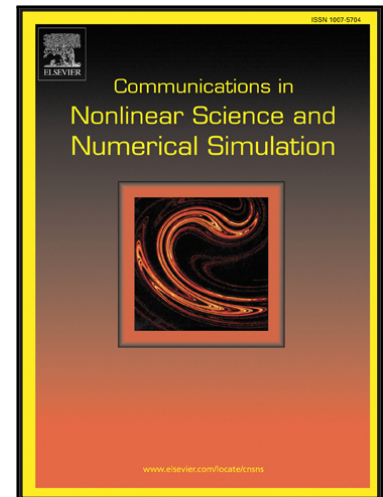

To appear in: *Communications in Nonlinear Science and Numerical Simulation*

Received date: 18 January 2019  
Revised date: 20 May 2019  
Accepted date: 26 June 2019

Please cite this article as: Tomasz P. Stefański, Jacek Gulgowski, Electromagnetic-based derivation of fractional-order circuit theory, *Communications in Nonlinear Science and Numerical Simulation* (2019), doi: <https://doi.org/10.1016/j.cnsns.2019.104897>

This is a PDF file of an unedited manuscript that has been accepted for publication. As a service to our customers we are providing this early version of the manuscript. The manuscript will undergo copyediting, typesetting, and review of the resulting proof before it is published in its final form. Please note that during the production process errors may be discovered which could affect the content, and all legal disclaimers that apply to the journal pertain.

### Highlights

- The proposed derivations of the foundations of fractional-order circuit theory are based on quasi-static approximations of fractional-order Maxwell's equations.
- Our approach is not limited by the geometry of the considered lumped RLC elements and employs the concepts of voltage and current known from the circuit theory.
- It can be further extended towards fractional-order multiterminal elements, described by e.g. capacitance, inductance and conductance matrices.
- The proposed theory is applied for interpretation of Poynting's theorem in the fractional-order electromagnetism, demonstrating its logical coherence and applicability.

# Electromagnetic-based derivation of fractional-order circuit theory

Tomasz P. Stefański<sup>a</sup>, Jacek Gulgowski<sup>b</sup>

<sup>a</sup>*Faculty of Electronics, Telecommunications, and Informatics, Gdansk University of Technology, Narutowicza 11/12, 80-233 Gdansk, Poland, email: tomasz.stefanski@pg.edu.pl*

<sup>b</sup>*Faculty of Mathematics, Physics and Informatics, University of Gdansk, Gdansk 80-308, Poland, email: jacek.gulgowski@mat.ug.edu.pl*

---

## Abstract

In this paper, foundations of the fractional-order circuit theory are revisited. Although many papers have been devoted to fractional-order modelling of electrical circuits, there are relatively few foundations for such an approach. Therefore, we derive fractional-order lumped-element equations for capacitors, inductors and resistors, as well as Kirchhoff's voltage and current laws using quasi-static approximations of fractional-order Maxwell's equations. The proposed approach is not limited by the geometry of the considered lumped elements and employs the concepts of voltage and current known from the circuit theory. Finally, the proposed theory of circuit elements is applied to interpretation of Poynting's theorem in fractional-order electromagnetism.

*Keywords:* Fractional order circuits, Maxwell's equations, Riemann-Liouville derivative

---

## 1. Introduction

The integer-order circuit theory is well established based on quasi-static (QS) approximations of Maxwell's equations [1, 2, 3], which allow for formulation of lumped-element circuit equations for capacitors (C), inductors (L) and resistors (R), as well as Kirchhoff's voltage and current laws. However, although many papers are devoted to fractional-order modelling of electrical circuits [4, 5, 6, 7, 8, 9], to the best of the authors' knowledge there are no strong foundations for such an approach. In [10], the formulation of

*Preprint submitted to Communications in Nonlinear Science and Numerical Simulation July 1, 2019*

lumped-element equations for capacitors, inductors and resistors is presented. However, it is not general and flexible enough in terms of the geometry of basic circuit elements. That is, it assumes that the fractional-order capacitor consists of two parallel plates confining a dielectric described by the fractional-order derivative, the fractional-order inductor is a toroidal frame of rectangular cross section, and the fractional-order resistor is cylindrical. In [11], the RLC circuit elements are identified in fractional-order Maxwell's equations based on the characteristic impedance of a fractional-order electromagnetic system, given by the ratio of the electric and magnetic fields. However, such an approach does not employ the concepts of voltage and current, which are typical for the circuit theory. Recent discussion in literature [12, 13] suggests that clear derivations of the fractional-order circuit theory foundations from electromagnetism are necessary.

Fractional-order circuits and systems design is definitely an emerging area of interdisciplinary research [14]. The number of published papers in different areas is increasing and will continue to grow in parallel with the diffusion of the theory [15]. Hence, the growing number of applications and implementations of fractional-order circuits and systems is a motivation for our research. Therefore, we have decided to revisit the fractional-order circuit theory foundations. The proposed derivations are based on QS approximations [2] of fractional-order Maxwell's equations [16, 17, 18, 19, 20] establishing the fractional-order electrodynamics [21, 22, 23, 24, 25, 26]. Furthermore, our approach is not limited by the geometries of the considered lumped elements and employs the concepts of voltage and current known from the circuit theory. Hence, it can be further extended towards fractional-order multi-terminal elements, described by e.g. capacitance, inductance and conductance matrices [2]. In the next step, Kirchhoff's voltage and current laws as well as the power conservation law are derived. Finally, the proposed theory of circuit elements is applied for interpretation of Poynting's theorem in the fractional-order electromagnetism.

## 2. Basic Definitions of Fractional Calculus

Mathematical foundations of the fractional order calculus have a very long history, which dates back to the beginnings of calculus itself, and to some ideas of Leibniz. The concept was later developed, and proved useful not only in mathematics, by numerous mathematicians - including Euler, Abel, Liouville and Riemann, to name but a few. For the historical outline,



we refer to the appropriate chapters of [27, 28, 29]. Throughout the paper, we **have tried** to employ basic definitions consistent with the terminology proposed in [10].

The Riemann-Liouville integral of the function  $f : \mathbb{R} \mapsto \mathbb{R}$  is defined as

$$J^\alpha f(t) = \frac{1}{\Gamma(\alpha)} \int_{a=0}^t f(\tau)(t-\tau)^{\alpha-1} d\tau \quad (1)$$

where  $\alpha > 0$  is an order of integration,  $\Gamma$  is the Gamma function and  $a$  is a fixed base point set to zero. Based on this definition, the Riemann-Liouville derivative of order  $\alpha$  is introduced as

$$D^\alpha f(t) = DJ^{1-\alpha} f(t). \quad (2)$$

It is worth referring here to a similar concept of the Caputo derivative (see Section 2.4. of [29]). This derivative definition and the Riemann-Liouville derivative are actually the same for functions  $f$ , such that  $f(a) = 0$  ( $a$  is the base point). It appears though, that Riemann-Liouville derivative  $D^\alpha f$  offers an advantageous transition between  $f(t)$  and  $f'(t)$  as  $\alpha$  changes from 0 to 1. As seen in [30, Formula (1.14)], the Riemann-Liouville derivative satisfies the property

$$\lim_{\alpha \rightarrow 0^+} (D^\alpha f)(t) = f(t) \quad (3)$$

whereas the Caputo derivative ( $D_C^\alpha$ ) satisfies the property

$$\lim_{\alpha \rightarrow 0^+} (D_C^\alpha f)(t) = f(t) - f(a). \quad (4)$$

In this case, the Caputo derivative gives the result which might depend on the choice of the base point. Therefore, from now on we focus in our considerations on the Riemann-Liouville definition.

The properties of Riemann-Liouville fractional order integrals and derivatives are thoroughly explained in classical **monographs**, e.g. [27, 28, 29]. Let us now **recall** some of these properties, which are referred to in the sequel.

**Theorem 1** ([28, Lemma 2.1.], see also [29, Theorem 3.11]). *If  $f : [0, +\infty) \rightarrow \mathbb{R}$  is an absolutely continuous function<sup>1</sup>, then  $J^\alpha f(t)$  is an absolutely contin-*

<sup>1</sup>One of the equivalent characterization of absolutely continuous function on the interval  $[a, b]$  is the function  $f$  which is almost everywhere differentiable, the derivative is an integrable function and such that  $f(t) = f(a) + \int_a^t f'(s)ds$ . However, we may also **use the** stronger assumption of  $f$  **being continuously differentiable**.



uous function and

$$J^\alpha f(t) = \frac{1}{\Gamma(1+\alpha)} \left( f(0)t^\alpha + \int_0^t f'(\tau)(t-\tau)^\alpha \right).$$

**Remark 1.** From the proof of the theorem, one can see that if the derivative  $f'$  is continuous, then  $J^\alpha f(t)$  is not only absolutely continuous but is also differentiable everywhere, and its derivative is a continuous function.

**Corollary 1** ([29, Corollary 2.1]). If  $\alpha \in (0, 1)$  then

$$D^\alpha f(t) \equiv 0 \Leftrightarrow f(t) = c \cdot t^{\alpha-1}$$

for  $t > 0$  and constant  $c \in \mathbb{R}$ .

In what follows, we refer to multivariate fractional calculus (for the entire theory see [28, Chapter 5.]). The definition of the fractional derivative is very natural (see [28, Formula (24.9)]) and we do not repeat it here. Still, we should mention that although, in general, the definition depends on the order of differentiation when we assume that  $f$  is continuously differentiable up to the order of  $m$ , this definition does not depend on the order of derivatives (see the discussion in [28, Section 24.2]).

From now on, we assume that all the functions  $f: [0, +\infty) \times V \rightarrow \mathbb{R}$  and vector fields  $\mathbf{F}: [0, +\infty) \times V \rightarrow \mathbb{R}^3$ , for a certain volume  $V \subset \mathbb{R}^3$ , are of an appropriate smoothness – it would be safe to assume that they all belong to the space  $C^3([0, +\infty) \times V)$ , meaning that derivatives up to the third order exist and are continuous.

### 3. Fractional Order Maxwell's Equations

Let us consider Maxwell's equations in free space

$$\nabla \cdot \mathbf{D} = \rho \tag{5}$$

$$\nabla \times \mathbf{E} = -\frac{\partial \mathbf{B}}{\partial t} \tag{6}$$

$$\nabla \cdot \mathbf{B} = 0 \tag{7}$$

$$\nabla \times \mathbf{H} = \frac{\partial \mathbf{D}}{\partial t} + \mathbf{J} \tag{8}$$



where  $\mathbf{E}$  and  $\mathbf{H}$  denote respectively the electric- and magnetic-field intensity,  $\mathbf{D}$  and  $\mathbf{B}$  denote respectively the displacement- and magnetic-flux density,  $\mathbf{J}$  denotes the current density and  $\rho$  denotes the charge density. For space without sources, the current density can be related to the electric-field intensity by the generalized fractional-order Ohm's law [10]

$$\mathbf{J} = \sigma_\alpha D_t^{1-\alpha} \mathbf{E}, \quad 0 < \alpha \leq 1 \quad (9)$$

which reduces to the classical law for  $\alpha = 1$ , i.e.

$$\mathbf{J} = \sigma_1 \mathbf{E}. \quad (10)$$

Other constitutive relations for the electromagnetic medium described by the fractional-order model (FOM) are assumed as follows:

$$\epsilon_\beta \mathbf{E} = D_t^{1-\beta} \mathbf{D}, \quad 0 < \beta \leq 1 \quad (11)$$

$$\mu_\gamma \mathbf{H} = D_t^{1-\gamma} \mathbf{B}, \quad 0 < \gamma \leq 1. \quad (12)$$

For  $\beta = 1$  and  $\gamma = 1$ , one obtains the constitutive relations for the media described by the integer-order model (IOM), with permittivity  $\epsilon_1$  and permeability  $\mu_1$

$$\mathbf{D} = \epsilon_1 \mathbf{E} \quad (13)$$

$$\mathbf{B} = \mu_1 \mathbf{H}. \quad (14)$$

In the case of a vacuum, the permittivity and permeability are denoted as  $\epsilon_0$  and  $\mu_0$ , respectively. The problem of dimensional non-uniformity of FOMs [13] is solved by taking the following SI units for parameters in (9), (11), (12):  $[\sigma_\alpha] = \frac{(\Omega m)^{-1}}{\text{sec}^{\alpha-1}}$ ,  $[\epsilon_\beta] = \frac{F}{\text{sec}^{1-\beta m}}$ ,  $[\mu_\gamma] = \frac{H}{\text{sec}^{1-\gamma m}}$ .

Equations (11)–(12) describe the media with power-law frequency dispersion [24, 25, 31]. For instance, power-laws are a common feature of the dielectric response of most materials for wide frequency ranges. Dielectrics are known in electrodynamics, with the so-called universal response being described by fractional derivatives, which obey the universal fractional power law and the fractional Curie-von Schweidler law. However, in circuit modelling, the physical microscopic mechanisms causing power-law dispersion for the media are not investigated. Therefore, we only postulate constitutive relations (9), (11), (12) for the considered electromagnetic media described by FOM and we do not limit considerations to any particular microscopic model

of dielectric or magnetic material. It is worth noticing that the fractional-order relation (12) is also allowed with regard to the magnetic field in the considered electromagnetic media.

Circuit theory modelling assumes that time rates of change are slow enough (frequencies are low enough), so that time delays resulting from the propagation of electromagnetic waves are unimportant. Under this assumption, QS approximations of Maxwell's equations (5)–(8) can be obtained [2]. In the proposed derivations, we distinguish the electro-quasi-static (EQS) approximation

$$\nabla \cdot \mathbf{D} = \rho \quad (15)$$

$$\nabla \times \mathbf{E} = 0 \quad (16)$$

$$\nabla \cdot \mathbf{B} = 0 \quad (17)$$

$$\nabla \times \mathbf{H} = \frac{\partial \mathbf{D}}{\partial t} + \mathbf{J} \quad (18)$$

and the magneto-quasi-static (MQS) approximation

$$\nabla \cdot \mathbf{D} = \rho \quad (19)$$

$$\nabla \times \mathbf{E} = -\frac{\partial \mathbf{B}}{\partial t} \quad (20)$$

$$\nabla \cdot \mathbf{B} = 0 \quad (21)$$

$$\nabla \times \mathbf{H} = \mathbf{J}. \quad (22)$$

The EQS and MQS approximations are obtained assuming respectively that  $\frac{\partial \mathbf{B}}{\partial t} \approx 0$  and  $\frac{\partial \mathbf{D}}{\partial t} \approx 0$  in Maxwell's equations (5)–(8).

#### 4. Fractional Order Circuit Elements

In this section, we introduce capacitance, inductance and resistance in the medium described by FOM based on analogous definitions for IOM. We assume that the media inside the considered circuit elements are isotropic and homogeneous.





#### 4.1. Resistance

The application of the divergence operator to (18) gives the charge conservation law in the EQS approximation

$$\nabla \cdot \mathbf{J} + \frac{\partial \rho}{\partial t} = 0. \quad (23)$$

We assume as in [2], that excitations are essentially constant in time, in the sense that the rate of accumulation of charge at any given location has negligible influence on the distribution of current density. Hence, the time derivative of the charge density in the charge conservation law (23), is negligible and the current density is consequently solenoidal, i.e.

$$\nabla \cdot \mathbf{J} = 0. \quad (24)$$

Let us consider the system consisting of two electrodes (connected to terminals) in a conducting medium described by IOM, i.e. a resistor, as shown in Fig. 1. Let us assume that the EQS approximation can be applied to this system. A conductance  $G$  between the two electrodes is defined as the ratio of the electrode current  $i$  and the voltage  $v$  between two electrodes, i.e.

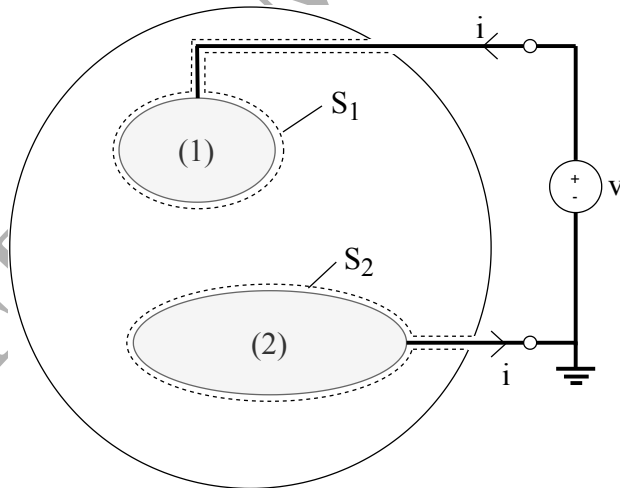

Figure 1: Resistor consisting of two electrodes for conductance definition.

$$G = \frac{i}{v}. \quad (25)$$

where

$$i = \oint_{S_1} \mathbf{J} \cdot d\mathbf{a} = - \oint_{S_2} \mathbf{J} \cdot d\mathbf{a} \quad (26)$$

and

$$v = \int_{(1)}^{(2)} \mathbf{E} \cdot d\mathbf{s}. \quad (27)$$

Equations (26) and (27) stem from the current-density definition and integral formulation of (16), respectively. The electric field is irrotational, hence the integral (27) can be calculated along any contour connecting the electrodes 1 and 2. Furthermore, the electric field intensity is the negative gradient of the scalar electric potential  $\Phi$ , i.e.

$$\mathbf{E} = -\nabla\Phi. \quad (28)$$

In the case of the conducting medium described by IOM, one can write

$$i = \sigma_1 \oint_{S_1} \mathbf{E} \cdot d\mathbf{a}. \quad (29)$$

Based on (10), (24) and (28), one obtains the Laplace equation for the conducting medium described by IOM between the electrodes

$$\nabla^2\Phi = 0. \quad (30)$$

In what follows, we assume that the electric-field potential  $\Phi: [0, +\infty) \times V \rightarrow \mathbb{R}$ , defined in a certain volume  $V \subset \mathbb{R}^3$ , is the function of the form

$$\Phi(t, x, y, z) = \phi(t)\Phi_0(x, y, z), \quad (31)$$

satisfying the following assumptions

- (A1)  $\phi: [0, +\infty) \rightarrow \mathbb{R}$  is continuous with the derivative continuous in  $(0, +\infty)$ ;
- (A2)  $\Phi_0: V \rightarrow \mathbb{R}$  belongs to class  $C^2$ .

That is, the QS solution (31) to Maxwell's equations is obtained from the static solution  $\Phi_0$  by its multiplication with the time-varying function  $\phi(t)$ . It is a reasonable assumption, taking into account that the QS approach assumes no time retardation of potentials, hence, the QS solution has the same spatial distribution as the static solution, but it may vary temporally.

Let us now consider the system consisting of two electrodes in a conducting medium described by FOM, i.e. a fractional-order resistor, as shown in

Fig. 1. In this case, the conductance formula (25) can be generalized to a differential operator, which maps the voltage function  $v = v(t)$  to the current function  $i = i(t)$

$$i = \mathcal{G}_\alpha v. \quad (32)$$

Taking advantage of the current-density definition and the constitutive relation for the conducting medium described by FOM (9), one obtains for the  $S_1$  surface

$$\mathcal{G}_\alpha v = \oint_{S_1} \mathbf{J} \cdot d\mathbf{a} = \oint_{S_1} \sigma_\alpha D_t^{1-\alpha} \mathbf{E} \cdot d\mathbf{a} = \sigma_\alpha D_t^{1-\alpha} \oint_{S_1} \mathbf{E} \cdot d\mathbf{a}. \quad (33)$$

In the case of the conducting medium described by FOM, the scalar electric potential solves the following equation resulting from (9), (24), (28):

$$\nabla \cdot D_t^{1-\alpha} \nabla \Phi = 0. \quad (34)$$

In accordance with the assumptions (A1)–(A2), we may change the order of differentiation and write

$$\nabla^2 \Phi_0 D_t^{1-\alpha} \phi = 0.$$

One should notice that if  $D_t^{1-\alpha} \phi \equiv 0$ , then  $\phi(t) = Ct^{\alpha-1}$ , hence, it is unbounded in the neighbourhood of 0, and the function  $\phi$  does not satisfy the natural assumption (A1). Therefore, we can conclude that  $D_t^{1-\alpha} \phi = \psi(t) \neq 0$ . Then, for some  $t_0 \in (0, +\infty)$ , we have  $\psi(t_0) \neq 0$  leading to

$$\nabla^2 \Phi = 0. \quad (35)$$

This means that a  $\Phi$  solution for the resistor in a conducting medium described by IOM is also (for a fixed time  $t$ ) a solution for the same geometry of the resistor in a conducting medium described by FOM. Independent of the media type, the EQS approximation (16) requires that the Laplace equations (30), (35) be satisfied by the scalar electric potential  $\Phi$ . Hence, (33) can be written with the use of (25) and (29) as

$$\mathcal{G}_\alpha v = G_1 \frac{\sigma_\alpha}{\sigma_1} D_t^{1-\alpha} v \quad (36)$$

where  $G_1$  denotes the conductance in a conducting medium described by IOM, resulting from reference calculations for  $\alpha = 1$ . Then, one can obtain from (36) the formula for the conductance operator, i.e.

$$\mathcal{G}_\alpha = G_\alpha D_t^{1-\alpha} \quad (37)$$



where  $G_\alpha = G_1 \frac{\sigma_\alpha}{\sigma_1}$  (referred to as pseudo-conductance). The SI unit for the pseudo-conductance is  $[G_\alpha] = \frac{S}{\text{sec}^{\alpha-1}}$  which results from the constitutive relation (9).

In the next step, one can define the resistance operator  $\mathcal{R}_\alpha$ , which is the inverse of the differential conductance operator, i.e.

$$\mathcal{G}_\alpha \mathcal{R}_\alpha = \mathcal{R}_\alpha \mathcal{G}_\alpha = \mathcal{I} \quad (38)$$

where  $\mathcal{I}$  denotes the identity operator. Hence, the resistance formula maps the current function  $i = i(t)$  to the voltage function  $v = v(t)$  and is given by

$$\mathcal{R}_\alpha = \mathcal{G}_\alpha^{-1} = G_\alpha^{-1} J_t^{1-\alpha} = G_\alpha^{-1} D_t^{\alpha-1}. \quad (39)$$

#### 4.2. Capacitor

Let us consider the system consisting of two electrodes (connected to terminals) in a medium described by IOM, i.e. a capacitor, as shown in Fig. 2. Let us also assume that the EQS approximation can be applied to this system. Let us assume that the charge on the electrode 1 ( $q_1$ ) is brought to it by a voltage source ( $v$ ), which takes the charge away from the electrode 2 and deposits it on the electrode 1. Then, the charge on the electrode 2 ( $q_2$ ) equals  $-q_1$ , i.e.  $q_2 = -q_1$ . The capacitance  $C$  between the two electrodes is defined as the ratio of charge on the electrode 1 divided by the voltage between the two electrodes, i.e.

$$C = \frac{q}{v} \quad (40)$$

where

$$q = \oint_{S_1} \mathbf{D} \cdot d\mathbf{a} = - \oint_{S_2} \mathbf{D} \cdot d\mathbf{a} \quad (41)$$

and

$$v = \int_{(2)}^{(1)} \mathbf{E} \cdot d\mathbf{s}. \quad (42)$$

Equations (41) and (42) stem from integral formulations of (15) and (16), respectively. The electric field is irrotational, hence the integral (42) can be calculated along any contour connecting the electrodes 1 and 2. Furthermore, the electric field intensity is the negative gradient of the scalar electric potential  $\Phi$ , i.e.

$$\mathbf{E} = -\nabla\Phi. \quad (43)$$

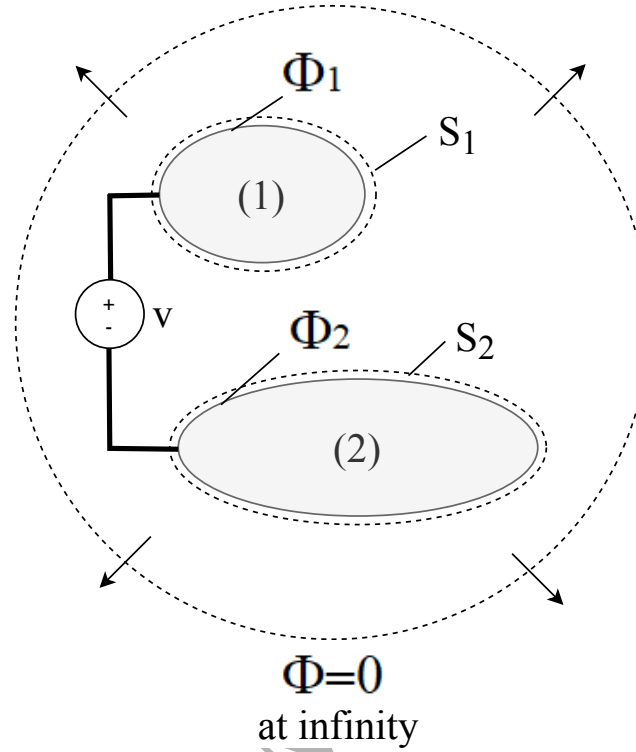

Figure 2: Capacitor consisting of two electrodes for capacitance definition.

When the medium described by IOM is a vacuum, one can write

$$q = \epsilon_0 \oint_{S_1} \mathbf{E} \cdot d\mathbf{a}. \quad (44)$$

Based on (15) and (43), one obtains the Laplace equation for the medium described by IOM in the space between the two electrodes

$$\nabla^2 \Phi = 0. \quad (45)$$

Let us now consider the system consisting of two electrodes in a medium described by FOM, i.e. a fractional-order capacitor, as shown in Fig. 2. In this case, the capacitance formula (40) can be generalized towards a differential operator, which maps the voltage function  $v = v(t)$  to the charge function  $q = q(t)$

$$q = \mathcal{C}_\beta v. \quad (46)$$

Taking advantage of Gauss's law (41) and the constitutive relation for the medium described by FOM (11), one obtains for the  $S_1$  surface

$$D_t^{1-\beta} \mathcal{C}_\beta v = D_t^{1-\beta} \oint_{S_1} \mathbf{D} \cdot d\mathbf{a} = \oint_{S_1} \epsilon_\beta \mathbf{E} \cdot d\mathbf{a} = \epsilon_\beta \oint_{S_1} \mathbf{E} \cdot d\mathbf{a}. \quad (47)$$

In the case of the electromagnetic medium described by FOM, the scalar electric potential satisfies the following equation resulting from (11), (15), (43):

$$\nabla \cdot \epsilon_\beta \nabla \Phi = 0. \quad (48)$$

Hence, one obtains

$$\nabla^2 \Phi = 0. \quad (49)$$

It means that a  $\Phi$  solution for the capacitor in a medium described by IOM is also (for a fixed time  $t$ ) a solution for the same geometry of the capacitor in a medium described by FOM. Hence, (47) can be written with the use of (40) and (44) as

$$\mathcal{C}_\beta v = C_0 \frac{\epsilon_\beta}{\epsilon_0} D_t^{\beta-1} v \quad (50)$$

where  $C_0$  denotes the capacitance in the medium described by IOM being the vacuum. Then, one can conclude from (50) the formula for the capacitance operator, i.e.

$$\mathcal{C}_\beta = C_\beta D_t^{\beta-1} \quad (51)$$

where  $C_\beta = C_0 \frac{\epsilon_\beta}{\epsilon_0}$ . The parameter  $C_\beta$  is a constant (referred to as pseudo-capacitance [9] or supercapacity [13]) in the circuit equation defining the fractional-order capacitor, i.e.

$$i = D_t q = C_\beta D_t^\beta v. \quad (52)$$

The SI unit for the pseudo-capacitance is  $[C_\beta] = \frac{F}{\text{sec}^{1-\beta}}$  which results from the constitutive relation (11).

### 4.3. Inductor

Let us consider an inductor having terminals 1 and 2, that links flux through the surface enclosed by a contour composed of the path  $P_a$  along the perfect electric conductor (PEC) and the path  $P_b$  completing the circuit between the terminals, see Fig. 3. If the voltage is to be a well-defined quantity, independent of the layout of the connecting wires, the terminals of the inductor must be in a region where the magnetic induction is negligible

compared to that in other regions and where, as a result, the EQS approximation can be applied and the electric field is irrotational [2]. Hence, the induced voltage between the terminals 1 and 2 is the negative integral of the electric field intensity along the path  $P_b$ , i.e.

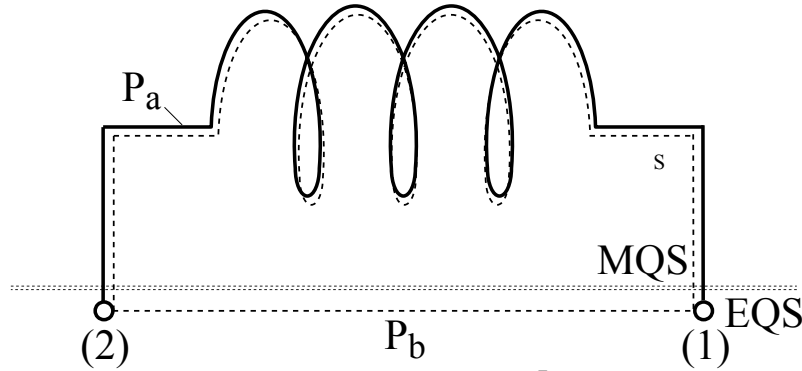

Figure 3: Inductor consisting of a wire with two terminals for inductance definition.

$$v = \Phi_1 - \Phi_2 = \int_{(1) P_b}^{(2)} \mathbf{E} \cdot d\mathbf{s}, \quad (53)$$

for which the EQS approximation can be applied. Because the electric field intensity is zero along the perfectly conducting wire, one obtains

$$\oint_{P_a+P_b} \mathbf{E} \cdot d\mathbf{s} = \int_{(1) P_a}^{(2)} \mathbf{E} \cdot d\mathbf{s} + \int_{(2) P_b}^{(1)} \mathbf{E} \cdot d\mathbf{s} = -v. \quad (54)$$

Then, the voltage between the terminals 1 and 2 can be determined with the use of the integral form of Faraday's law (20)

$$v = D_t \lambda \quad (55)$$

where

$$\lambda = \oint_S \mathbf{B} \cdot d\mathbf{a}. \quad (56)$$

It is worth noticing the importance of having the terminals in a region where the magnetic induction is negligible; hence the EQS approximation can be applied to the terminals 1 and 2, whereas the MQS approximation is applied to the rest of the inductor. The inductance  $L$  between the terminals 1 and 2



is defined for the inductor in a medium described by IOM as the ratio of the flux linkage and the terminal current, i.e.

$$L = \frac{\lambda}{i}. \quad (57)$$

In the case of PEC within the medium described by IOM being a vacuum, one can write

$$\lambda = \mu_0 \oint_S \mathbf{H} \cdot d\mathbf{a}. \quad (58)$$

We assume that the medium adjacent to PEC does not contain any currents  $J$ . Hence, the magnetic field intensity is irrotational in this medium (refer to (22)), and can be calculated as the negative gradient of the scalar magnetic potential  $\Psi$ , i.e.

$$\mathbf{H} = -\nabla\Psi. \quad (59)$$

Based on (14), (21) and (59), one obtains for the medium described by IOM in the space adjacent to PEC

$$\nabla^2\Psi = 0. \quad (60)$$

Let us now consider the inductor in an electromagnetic medium described by FOM, i.e. a fractional-order inductor, as shown in Fig. 3. In this case, the inductance formula (57) can be generalized towards a differential operator, which maps the current function  $i = i(t)$  to the flux-linkage function  $\lambda = \lambda(t)$

$$\lambda = \mathcal{L}_\gamma i. \quad (61)$$

Taking advantage of the constitutive relation (12), one obtains, for the surface  $S$

$$D_t^{1-\gamma} \mathcal{L}_\gamma i = D_t^{1-\gamma} \oint_S \mathbf{B} \cdot d\mathbf{a} = \oint_S \mu_\gamma \mathbf{H} \cdot d\mathbf{a} = \mu_\gamma \oint_S \mathbf{H} \cdot d\mathbf{a}. \quad (62)$$

In the case of the medium described by FOM, the scalar magnetic potential also solves the Laplace equation (60) resulting from (12), (21), (59). It means that a  $\Psi$  solution for the inductor in a medium described by IOM is also a solution for the same geometry of the inductor in a medium described by FOM. Hence, (62) can be written with the use of (57) and (58) as

$$D_t^{1-\gamma} \mathcal{L}_\gamma i = L_0 \frac{\mu_\gamma}{\mu_0} i \quad (63)$$





where  $L_0$  denotes inductance of the considered wire in [the medium described by IOM](#) being the vacuum. Then, one can conclude from (63) the formula for the inductance operator, i.e.

$$\mathcal{L}_\gamma = L_\gamma D_t^{\gamma-1} \quad (64)$$

where  $L_\gamma = L_0 \frac{\mu_\gamma}{\mu_0}$ . The parameter  $L_\gamma$  is a constant (referred to as pseudo-inductance [9]) in the circuit equation defining the fractional-order inductor, i.e.

$$v = D_t \lambda = L_\gamma D_t^\gamma i. \quad (65)$$

The SI unit for the pseudo-inductance is  $[L_\gamma] = \frac{H}{\text{sec}^{1-\gamma}}$ , which results from the constitutive relation (12).

## 5. Kirchhoff's voltage and current laws

In this section, Kirchhoff's voltage law (KVL) and Kirchhoff's current law (KCL) are derived for fractional-order circuits based on the QS approximations of Maxwell's equations for the sake of comprehensive approach to the topic. Then, the power conservation law (PCL) is obtained.

### 5.1. KVL

Let us consider a closed loop in a circuit as [shown](#) in Fig. 4. The electric field intensity along the loop consists of the impressed electric intensity (voltage sources) and the electric intensity due to the reaction of currents and charges in the circuit elements [1]. Independent of the element order, one can distinguish in such a loop resistors and capacitors for which the EQS approximation is applied, and inductors for which the MQS approximation is applied. However, we assume that for any inductor (refer to Section 4), as well as [for](#) voltage sources, the EQS approximation is still valid between [the](#) terminals. Therefore, for any closed loop consisting of resistors, capacitors, inductors and voltage sources, the electric field intensity is irrotational (16), and then its integral along a path being a closed circuit loop equals zero, i.e.

$$\oint_P \mathbf{E} \cdot d\mathbf{s} = 0. \quad (66)$$

Integration of the electric field intensity between [the](#) terminals of circuit elements gives terminal voltages (e.g.  $v_R$ ,  $v_C$ ,  $v_L$ ,  $v_S$ ). However, in the case of inductors and voltage sources, integration paths are around the exterior



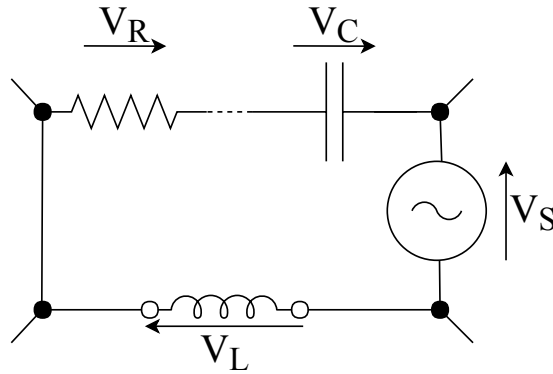

Figure 4: Closed loop of a fractional-order circuit.

of each of the components, from one terminal to the other in the space under the EQS approximation. With the use of (66), one obtains KVL

$$\sum_{n=0}^k v_n = 0. \quad (67)$$

### 5.2. KCL

Let us consider a circuit node as in Fig. 5. Here, as in Section 4.1, we assume that the EQS approximation is valid around the node, hence the current density is solenoidal (24). Therefore, the current flux through any closed surface around the circuit node equals zero, i.e.

$$\oint_S \mathbf{J} \cdot d\mathbf{a} = 0. \quad (68)$$

Integration of the current density (68) over cross sections of wires in the node results in KCL

$$\sum_{n=0}^k i_n = 0 \quad (69)$$



where currents flowing into the node are taken with a minus sign and currents flowing out of the node are taken with a plus sign.

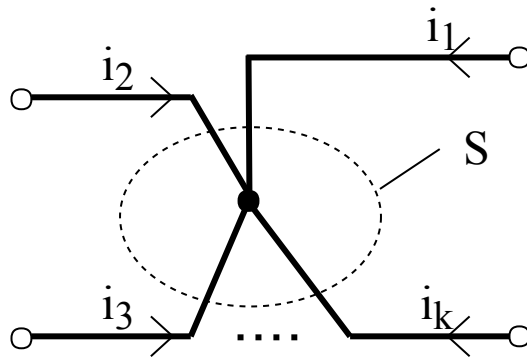

Figure 5: Node of a fractional-order circuit.

### 5.3. PCL

If KVL and KCL are satisfied, then, according to Tellegen's theorem [32, 33, 34], the sum of instantaneous powers at all elements in a circuit equals zero, i.e.

$$\sum_{n=0}^k v_n i_n = 0. \quad (70)$$

## 6. Application: Interpretation of fractional-order Poynting's theorem

Although the circuit theory stems from the QS approximation of Maxwell's equations, their discretization results in lumped-element circuit models [which allow for solving](#) these equations. Such an approach is widely used in computational electromagnetics, e.g. in the transmission-line matrix method [3, 35] which solves lumped-element circuit models to obtain solutions to Maxwell's equations.

Let us consider equations defining fractional-order capacitor (52) and inductor (65). The electric power  $p = p(t)$  (the rate, per [time](#) unit at which electrical energy  $w = w(t)$  is transferred by a considered circuit element) is given by

$$p = D_t w = vi. \quad (71)$$



Hence, one obtains the following formulas for power calculations in the fractional-order capacitor

$$p_C = C_\beta v D_t^\beta v \quad (72)$$

and inductor

$$p_L = L_\gamma i D_t^\gamma i. \quad (73)$$

However, the changes of energy in a fractional-order capacitor (as well as in an inductor) are associated not only with energy storage but also with its dissipation [36].

Let us now consider fractional-order curl Maxwell's equations in free space (6), (8). Taking into account constitutive relations (11), (12), one obtains

$$\nabla \times \mathbf{E} = -\mu_\gamma D_t^\gamma \mathbf{H} \quad (74)$$

$$\nabla \times \mathbf{H} = \epsilon_\beta D_t^\beta \mathbf{E} + \mathbf{J}. \quad (75)$$

Let us multiply (74) by  $\mathbf{H}$  and (75) by  $\mathbf{E}$  [2]. Then, one obtains

$$\mathbf{H} \cdot (\nabla \times \mathbf{E}) = -\mu_\gamma \mathbf{H} \cdot D_t^\gamma \mathbf{H} \quad (76)$$

$$\mathbf{E} \cdot (\nabla \times \mathbf{H}) = \epsilon_\beta \mathbf{E} \cdot D_t^\beta \mathbf{E} + \mathbf{E} \cdot \mathbf{J}. \quad (77)$$

Subtracting (76) from (77) gives

$$\mathbf{E} \cdot (\nabla \times \mathbf{H}) - \mathbf{H} \cdot (\nabla \times \mathbf{E}) = \epsilon_\beta \mathbf{E} \cdot D_t^\beta \mathbf{E} + \mathbf{E} \cdot \mathbf{J} + \mu_\gamma \mathbf{H} \cdot D_t^\gamma \mathbf{H}. \quad (78)$$

Left-hand side of (78) can be represented as

$$\nabla \cdot (\mathbf{E} \times \mathbf{H}) = \mathbf{H} \cdot (\nabla \times \mathbf{E}) - \mathbf{E} \cdot (\nabla \times \mathbf{H}). \quad (79)$$

Hence, (78) can be written as

$$\nabla \cdot (\mathbf{E} \times \mathbf{H}) + \epsilon_\beta \mathbf{E} \cdot D_t^\beta \mathbf{E} + \mathbf{E} \cdot \mathbf{J} + \mu_\gamma \mathbf{H} \cdot D_t^\gamma \mathbf{H} = 0. \quad (80)$$

Suppose now that  $V \subset \mathbb{R}^3$  is a compact volume with the boundary  $S$  being the piecewise smooth surface. Then, using Gauss's theorem, one obtains

$$\oint_{S=\partial V} \mathbf{E} \times \mathbf{H} \cdot d\mathbf{a} + \int_V \epsilon_\beta \mathbf{E} \cdot D_t^\beta \mathbf{E} dv + \int_V \mathbf{E} \cdot \mathbf{J} dv + \int_V \mu_\gamma \mathbf{H} \cdot D_t^\gamma \mathbf{H} dv = 0. \quad (81)$$

It is the integral form of Poynting's theorem for fractional-order electromagnetics. Its interpretation can be introduced based on lumped-element circuit



models of the fractional-order capacitor and inductor. Let us assume that the current density can be related to the electric field intensity by the classical Ohm's law (10) for the sake of brevity. Then, the term  $\mathbf{E} \cdot \mathbf{J}$  is the power-dissipation density associated with Joule's heating.

Let us consider an infinitesimally small volume  $\Delta V = S\Delta l$  between the surfaces  $S_1$  and  $S_2$  perpendicular to the electric field intensity ( $S_1 \approx S_2 \approx S$ ), see Fig. 6. Introduction of PEC plates instead of  $S_1$  and  $S_2$  does not disturb the electric field and allows us to consider the volume as a fractional-order capacitor. Since the electric field  $\mathbf{E}$  is perpendicular to  $S$ , we may assume that  $\mathbf{E} = (0, 0, |\mathbf{E}|)$  in an appropriate coordinate system. Then, one obtains for  $v = |\mathbf{E}|\Delta l$

$$\epsilon_\beta \mathbf{E} \cdot D_t^\beta \mathbf{E} = \epsilon_\beta (\Delta l)^{-2} v D_t^\beta v = \epsilon_\beta (\Delta l)^{-2} p_C C_\beta^{-1} = \frac{p_C}{\Delta V} \quad (82)$$

because the capacitance of a parallel-plate vacuum capacitor is given by  $C_0 = \epsilon_0 S / \Delta l$ . Hence, the term  $\epsilon_\beta \mathbf{E} \cdot D_t^\beta \mathbf{E}$  denotes the increase rate of the

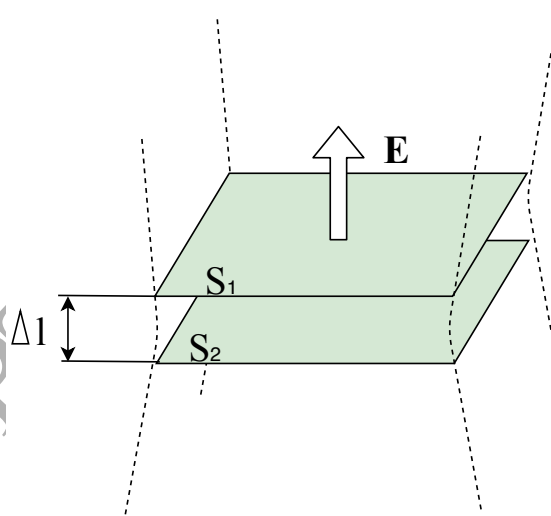

Figure 6: Infinitesimally small volume fractional-order capacitor storing and dissipating the energy of an electric field.

energy stored and dissipated in the electric field within the medium described by FOM.

Analogously, let us consider a single coil winding on side surfaces of an infinitesimally small volume  $\Delta V$ , see Fig. 7. Then, similarly as above, one



obtains for  $i = |\mathbf{H}|\Delta l$ ,  $\mathbf{H} = (0, 0, |\mathbf{H}|)$  (in an appropriate coordinate system)

$$\mu_\gamma \mathbf{H} \cdot D_t^\gamma \mathbf{H} = \mu_\gamma (\Delta l)^{-2} i D_t^\gamma i = \mu_\gamma (\Delta l)^{-2} p_L L_\gamma^{-1} = \frac{p_L}{\Delta V} \quad (83)$$

because the inductance of such a vacuum coil is given by  $L_0 = \mu_0 S / \Delta l$ .

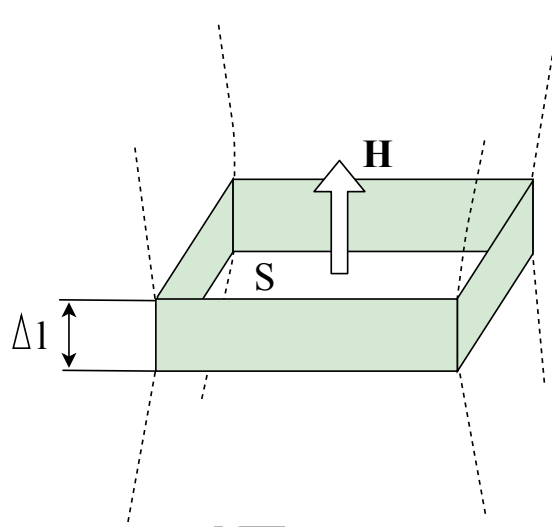

Figure 7: Infinitesimally small volume fractional-order inductor storing and dissipating the energy of a magnetic field.

Finally, (81) shows that the input power (surface integral of the power flux density  $\mathbf{E} \times \mathbf{H}$  [2]) is equal to the rate of increase of the total energy stored and dissipated in the medium described by FOM plus the power dissipation related to Joule's heating. The rate of increase of the total energy is expressed as an integral over the volume of power density in electric field (72) and in magnetic field (73) within the medium described by FOM. The occurrence of electromagnetic energy dissipation in the medium described by FOM is not easily visible in (80)–(81) without the interpretation based on lumped element models for which it is well known that the energy is not only stored but also dissipated [36].

## 7. Conclusions

In this paper, we present comprehensive derivations of the fractional-order circuit theory foundations from electromagnetism. The proposed derivations



are based on the QS approximations of fractional-order Maxwell's equations. This allows for formulation of fractional-order lumped-element equations for capacitors, inductors and resistors as well as Kirchhoff's voltage and current laws. Our derivations are not limited by the geometries of the considered fractional-order elements. Finally, the proposed theory is applied for interpretation of Poynting's theorem in fractional-order electromagnetism, demonstrating its logical coherence and applicability.

## 8. Acknowledgement

The authors sincerely thank the reviewers for useful comments and valuable suggestions aimed at the improvement of the manuscript.

## References

- [1] J. R. Carson, Electromagnetic theory and the foundations of electric circuit theory, *The Bell System Technical Journal* 6 (1) (1927) 1–17. doi:10.1002/j.1538-7305.1927.tb00189.x.
- [2] H. A. Haus, J. R. Melcher, *Electromagnetic fields and energy*, Prentice Hall Englewood Cliffs, N.J, 1989.
- [3] P. Russer, *Electromagnetics, Microwave Circuit, And Antenna Design for Communications Engineering, Second Edition* (Artech House Antennas and Propagation Library), Artech House, Inc., Norwood, MA, USA, 2006.
- [4] G. Carlson, C. Halijak, Approximation of fractional capacitors ( $1/s$ ) ( $\hat{1}/n$ ) by a regular newton process, *IEEE Transactions on Circuit Theory* 11 (2) (1964) 210–213. doi:10.1109/TCT.1964.1082270.
- [5] K. Steiglitz, An rc impedance approximant to  $s^{-1/2}$ , *IEEE Transactions on Circuit Theory* 11 (1) (1964) 160–161. doi:10.1109/TCT.1964.1082252.
- [6] T. Kaczorek, Positive linear systems consisting of  $n$  subsystems with different fractional orders, *IEEE Transactions on Circuits and Systems I: Regular Papers* 58 (6) (2011) 1203–1210. doi:10.1109/TCSI.2010.2096111.



- [7] A. Shamim, A. G. Radwan, K. N. Salama, Fractional smith chart theory, *IEEE Microwave and Wireless Components Letters* 21 (3) (2011) 117–119. doi:10.1109/LMWC.2010.2098861.
- [8] M. S. Sarafraz, M. S. Tavazoei, Realizability of fractional-order impedances by passive electrical networks composed of a fractional capacitor and rlc components, *IEEE Transactions on Circuits and Systems I: Regular Papers* 62 (12) (2015) 2829–2835. doi:10.1109/TCSI.2015.2482340.
- [9] M. S. Sarafraz, M. S. Tavazoei, Passive realization of fractional-order impedances by a fractional element and rlc components: Conditions and procedure, *IEEE Transactions on Circuits and Systems I: Regular Papers* 64 (3) (2017) 585–595. doi:10.1109/TCSI.2016.2614249.
- [10] M. A. Moreles, R. Lainez, Mathematical modelling of fractional order circuit elements and bioimpedance applications, *Communications in Nonlinear Science and Numerical Simulation* 46 (2017) 81 – 88. doi:https://doi.org/10.1016/j.cnsns.2016.10.020.  
URL <http://www.sciencedirect.com/science/article/pii/S1007570416303598>
- [11] G. Liang, J. Hao, D. Shan, Electromagnetic interpretation of fractional-order elements, *Journal of Modern Physics* 8 (2017) 2209–2218. doi:doi:10.4236/jmp.2017.814136.
- [12] R. Sikora, S. Pawłowski, Fractional derivatives and the laws of electrical engineering, *COMPEL - The international journal for computation and mathematics in electrical and electronic engineering* 37 (4) (2018) 1384–1391. arXiv:https://doi.org/10.1108/COMPEL-08-2017-0347, doi:10.1108/COMPEL-08-2017-0347.  
URL <https://doi.org/10.1108/COMPEL-08-2017-0347>
- [13] K. J. Latawiec, R. Stanisławski, M. Łukaniszyn, W. Czuczvara, M. Rydel, Fractional-order modeling of electric circuits: modern empiricism vs. classical science, in: *2017 Progress in Applied Electrical Engineering (PAEE)*, 2017, pp. 1–4. doi:10.1109/PAEE.2017.8008998.
- [14] A. S. Elwakil, Fractional-order circuits and systems: An emerging interdisciplinary research area, *IEEE Circuits and Systems Magazine* 10 (4) (2010) 40–50. doi:10.1109/MCAS.2010.938637.





- [15] M. D. Ortigueira, An introduction to the fractional continuous-time linear systems: the 21st century systems, *IEEE Circuits and Systems Magazine* 8 (3) (2008) 19–26. doi:10.1109/MCAS.2008.928419.
- [16] V. E. Tarasov, Fractional vector calculus and fractional maxwell's equations, *Annals of Physics* 323 (11) (2008) 2756 – 2778. doi:<https://doi.org/10.1016/j.aop.2008.04.005>. URL <http://www.sciencedirect.com/science/article/pii/S0003491608000596>
- [17] M. D. Ortigueira, M. Rivero, J. J. Trujillo, From a generalised helmholtz decomposition theorem to fractional maxwell equations, *Communications in Nonlinear Science and Numerical Simulation* 22 (1) (2015) 1036 – 1049. doi:<https://doi.org/10.1016/j.cnsns.2014.09.004>. URL <http://www.sciencedirect.com/science/article/pii/S1007570414004481>
- [18] R. Ismail, A. G. Radwan, Rectangular waveguides in the fractional-order domain, in: 2012 International Conference on Engineering and Technology (ICET), 2012, pp. 1–6. doi:10.1109/ICEngTechnol.2012.6396151.
- [19] E. K. Jaradat, R. S. Hijawi, J. M. Khalifeh, Maxwell's equations and electromagnetic lagrangian density in fractional form, *Journal of Mathematical Physics* 53 (3) (2012) 033505. arXiv:<https://doi.org/10.1063/1.3670375>, doi:10.1063/1.3670375. URL <https://doi.org/10.1063/1.3670375>
- [20] D. Baleanu, A. K. Golmankhaneh, A. K. Golmankhaneh, M. C. Baleanu, Fractional electromagnetic equations using fractional forms, *International Journal of Theoretical Physics* 48 (11) (2009) 3114–3123. doi:10.1007/s10773-009-0109-8. URL <https://doi.org/10.1007/s10773-009-0109-8>
- [21] N. Engheta, On fractional calculus and fractional multipoles in electromagnetism, *IEEE Transactions on Antennas and Propagation* 44 (4) (1996) 554–566. doi:10.1109/8.489308.
- [22] N. Engheta, On the role of fractional calculus in electromagnetic theory, *IEEE Antennas and Propagation Magazine* 39 (4) (1997) 35–46. doi:10.1109/74.632994.



- [23] A. N. Bogolyubov, A. A. Potapov, S. S. Rehviashvili, An approach to introducing fractional integro-differentiation in classical electrodynamics, *Moscow University Physics Bulletin* 64 (4) (2009) 365–368. doi:10.3103/S0027134909040031. URL <https://doi.org/10.3103/S0027134909040031>
- [24] V. E. Tarasov, Fractional integro-differential equations for electromagnetic waves in dielectric media, *Theoretical and Mathematical Physics* 158 (3) (2009) 355–359. doi:10.1007/s11232-009-0029-z. URL <https://doi.org/10.1007/s11232-009-0029-z>
- [25] V. Tarasov, *Fractional Dynamics: Application of Fractional Calculus to Dynamics of Particles, Fields and Media*, Springer-Verlag Berlin Heidelberg, 2011.
- [26] H. Nasrolahpour, A note on fractional electrodynamics, *Communications in Nonlinear Science and Numerical Simulation* 18 (9) (2013) 2589 – 2593. doi:<https://doi.org/10.1016/j.cnsns.2013.01.005>. URL <http://www.sciencedirect.com/science/article/pii/S1007570413000312>
- [27] K. B. Oldham, J. Spanier, *The Fractional Calculus*, Academic Press, Academic Press, New York, 1974.
- [28] S. G. Samko, A. A. Kilbas, O. I. Marichev, *Fractional Integrals and Derivatives: Theory and Applications*, Gordon and Breach, New York, 1993.
- [29] A. A. Kilbas, H. M. Srivastava, J. J. Trujillo, *Theory and Applications of Fractional Differential Equations*, Elsevier Science, 2006.
- [30] C. Li, F. Zeng, *Numerical Methods for Fractional Calculus*, Chapman and Hall/CRC, 2015.
- [31] S. Thevanayagam, Dielectric dispersion of porous media as a fractal phenomenon, *Journal of Applied Physics* 82 (5) (1997) 2538–2547. arXiv:<https://doi.org/10.1063/1.366065>, doi:10.1063/1.366065. URL <https://doi.org/10.1063/1.366065>
- [32] B. Tellegen, A general network theorem, with applications, *Philips Res. Rep.* 7 (1952) 259–296.



- [33] P. Penfield, R. Spence, S. Duinker, A generalized form of tellegen's theorem, *IEEE Transactions on Circuit Theory* 17 (3) (1970) 302–305. doi:10.1109/TCT.1970.1083145.
- [34] J. Osiowski, J. Szabatin, *Fundamentals of Circuit Theory* (in Polish), Scientific and Technical Publishing House, Warsaw, 1995.
- [35] T. Itoh, *Numerical techniques for microwave and millimeter-wave passive structures* / edited by Tatsuo Itoh, Wiley, New York, 1989.
- [36] M. Fouda, A. Elwakil, A. Radwan, A. Allagui, Power and energy analysis of fractional-order electrical energy storage devices, *Energy* 111 (2016) 785 – 792. doi:<https://doi.org/10.1016/j.energy.2016.05.104>. URL <http://www.sciencedirect.com/science/article/pii/S036054421630723X>