

FORECASTING BIOGAS FORMATION IN LANDFILLS

Zbigniew KNEBA*[✉], Jacek KROPIWNICKI*[✉], Jakub HADRZYŃSKI**, Maciej ZIÓŁKOWSKI***

*Gdansk University of Technology, ul. Gabriela Narutowicza 11/12, 80-233 Gdańsk, Poland

**Eko Dolina, Aleja Parku Krajobrazowego 99, 84-207 Łężyce, Poland

***KO-Energia, ul. Klonowa 52 lok. 17, 83-330 Lniska, Poland

zkneba@pg.edu.pl jkropiwn@pg.edu.pl dt.ziolkowski@gmail.com

received 6 September 2022, revised 5 January 2023, accepted 23 January 2023

Abstract: The aim of the present research was to develop a mathematical model for estimating the amount of viscous gas generated as a function of weather conditions. Due to the lack of models for predicting gas formation caused by sudden changes in weather conditions in the literature, such a model was developed in this study using the parameters of landfills recorded for over a year. The effect of temperature on landfill gas production has proved to be of particular interest. We constructed an algorithm for calculating the amount of the produced gas. The model developed in this study could improve the power control of the landfill power plant.

Key words: landfill gas, waste usage, atmospheric conditions on landfills

1. INTRODUCTION

The landfill is primarily a source of two greenhouse gases: carbon dioxide and methane. In the face of threats posed by greenhouse gas emissions to the atmosphere, special attention needs to be paid to methane gas. It's Global Warming Potential (GWP) = 28–36 (100 is the maximum value) (1). Since non-collected methane appears a major greenhouse gas source (regarding its impact factor), all new landfills must have methane facilities.

In the European Union, the binding regulation in the field of industrial emissions (integrated pollution prevention and control) is DIRECTIVE 2010/75/EU of the European Parliament and of the Council of Europe 24 November 2010 (2). In the directive, the emission limits for burning landfill gas are set on the levels presented in Tab. 1.

Tab. 1. Emission limits for burning landfill gas in combustion engines

Pollutant	Limit mg/Nm ³ /day
NO _x	350
SO ₂	200
Ash (solid particles of any kind)	50

The reduction of CH₄ emission to the atmosphere in the years 1990–2010 reached a level of 30%, In next ten years 2010 – 2020 is was reduced of next 10 % (3).

The phenomenon of methane formation in landfills has been analysed in numerous studies (4)(5) (6)(7). However, there are only few considerations on the impact of atmospheric conditions and the possibility of short-term prediction of changes in the amount of methane produced on the basis of the measurements of meteorological parameters (8).

Predicting and controlling the process of methane collection and use are the objectives of this study. The future perspective of this study would be to change the control procedure of the combustion engines used in landfills.

2. LANDFILL GAS PRODUCTION TECHNOLOGY

Fig. 1 shows a schematic of using landfill gas for electricity and heat production.

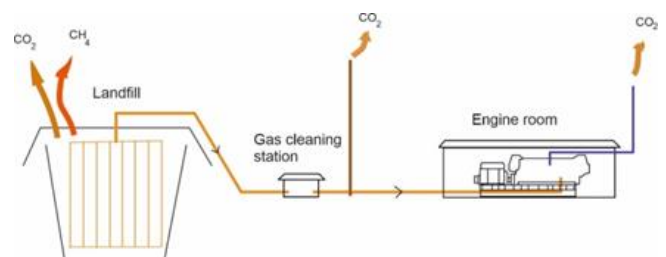

Fig. 1. Greenhouse gas emissions from landfill

There are several studies ([5,9,11,12,19]) on landfill gas LFG production in the world. These studies mostly differ in waste types and ambient conditions, but the gas collecting technology is the same in most cases (Fig. 1).

The collection system is a combination of horizontal and vertical collectors. Horizontal collectors are used for removing condensates and rain water, but they are also used in collecting LFG. The system has three phases: I: active cells, where new wastes are delivered; II: closed cells with temporary covers; and III: closed cells with final covers. Collection efficiencies for phases I, II and III are mostly set at 50%, 75 % and 95 % of its potential [4], respectively.

In this study, the authors used data recorded in the course of

operation of two sections (phases I and II) of a working ECODOLINA landfill serving the city of Gdynia in Poland. The service life of LFG collecting facilities can reach up to 80 years. Initially, the amount of produced methane is rising (for about 36 years), then it slowly and exponentially drops. In the first stage, when methane generation increases, the landfill is not able to create anaerobic conditions. In optimal conditions, only 40% of waste can be used for LFG production.

To control odour and to meet emission regulations, landfill operators collect and burn LFG. LFG collection efficiency varies mainly due to the LFG collector operation, types of cover and time of the installation of covers. Landfill consists of many cells and is often managed manually by the staff on a cell-by-cell basis. This operation requires more-experienced staff.

The amount of degradable organic carbon factor (DOCF) is proportional to the mass of wet waste DOCF (Tab. 1) and equals 0.5 for landfills that actively produce methane (7). This factor is very uncertain and depends on the type of waste. However, it can be used to assume LFG mass from the mass of waste.

Tab. 2. Material degradable organic factors [5]

Material	DOCF
Paper	0.19 ÷ 0.54
Wood	0.02 ÷ 0.57
Food waste	0.36 ÷ 0.92
Trimming grass	0.09 ÷ 0.38

DOCF, degradable organic carbon factor.

The volume of methane in a landfill gas is 54% ÷ 73%. In a landfill in the USA, waste consisted of paper 14.3%, wood 8.1%, food 21.6% and yard trimming 7.9% (7).

Producing electricity from LFG can be regarded as distributing regional electricity, which indirectly avoids CO₂ emissions. Electricity generated in landfills leads to a displacement credit of 550 g CO₂/kWh (5). The oxidation factor in landfill cover is amounting to 36% (9).

There are models in the literature describing the amount of methane produced at a landfill.

The model assumes that the entire amount of organic carbon that undergoes decomposition forms CH₄ and CO₂ (10). The formula to calculate the final amount of the produced decomposed methane from organic carbon is given in Eq. (1):

$$V_{CH_4}^{Year} = M_{OV}^{Y-1} \cdot (1 - e^{-k}) \cdot sh \cdot \frac{16}{12} \quad (1)$$

where: $V_{CH_4}^{Year}$ is the amount of methane generated in year Y, M_{OV} is the mass of organic carbon containing waste, k is the reaction rate constant in the year, sh is the share of methane in landfill gas and $\frac{16}{12}$ is the mass ratio of CH₄ to C.

The Gaussian model is another model that can be used for the simulation of LFG production when municipal solid waste (MSW) is pre-treated (11). The model assumes that the LFG production rate follows the normal distribution. The model is described by Formula (2):

$$V_{LFG}^{Day}(t) = a \cdot e^{-0.5 \frac{t-t_0}{b}}, \quad (2)$$

where $V_{LFG}^{Day}(t)$ is the LFG production rate in m³/(ton day), t is the time of digestion, a is the ultimate LFG production rate in m³/(ton day), b is constant in day and t_0 is the time in day where

the maximum LFG production rate occurred.

Next model was created as a result of research using an experimental reactor with a washed sample of landfill material by spreading the tested sample for a year (12).

More detailed models divide the deposited waste into fast, medium and slowly biodegradable waste. Their use is more difficult because most landfills does not register the types of waste. The equation that describes such method of calculation is given as follows (3):

$$V_{LFG}^{Day}(t) = \sum_{i=1}^n \sum_{j=0}^{m-1} A_{j+1}(t_i - t_j) e^{[-k_{j+1}(t_i - t_j)]}, \quad (3)$$

where: $V_{LFG}^{Day}(t)$ is the LFG production at time [m³/(t(MSW)*day)], A is the amplitude of LFG production at the day [m³/(t(MSW)*day)], k is the reaction rate constant in the year, n is the total number of days, m is the number of biodegradable components of heterogeneous pre-treated MSW and t_j is the delay time, which is defined as a period between the beginning and the end of biodegradable components.

Based on the literature review of the models of landfill gas formation, it can be concluded that they are functions of time and waste composition. These models are built to predict slow changes in operation over the years. However, there are no models for forecasting changes caused by temporary weather conditions with a forecast for several days

3. EXPERIMENTAL SETUP

The subject of the research was the ECODOLINA landfill in Lezyce, near Gdynia, Poland. It is a MSW landfill. Ambient conditions influence the formation of favourable conditions for fermentation. Recorded weather conditions included pressure, temperature, rainfall in 10-min increments and landfill gas production: gas flow, temperature, pressure, methane concentration and oxygen concentration. As LFG is obtained from anaerobic digestion, high humidity and temperature, alkaline environment (pH = 7.5) with maximally limited oxygen access is preferred for the process.

Depending on the temperature of the anaerobic fermentation process, it is possible to distinguish the following:

- mesophilic fermentation, which takes place at a temperature of about 30–40°C and
- thermophilic fermentation, which occurs at a temperature of about 52–58°C.

Mesophilic fermentation takes place in the deposits utilized by EKODOLINA due to waste accumulation in the open air. There are three sites at the landfill: 1979–2002, 1990–2002 and 2002 – currently. The LFG is obtained from 105 wells – 75 from old sites and 40 from new sites. The wells and drain collectors are connected to two main collectors that carry gas to the power plant. The concentration of methane obtained from these quarters differs significantly: the oldest site produced only 10% of the concentration of methane in LFG, newer site provide about 50%, and current site produced 60% of concentration. The composition of the landfill gas is checked periodically mainly to prevent failures of gas powered engines. If hazardous chemicals such as hydrogen sulphide or siloxanes are detected, the gas is proceeded for treatment. Carbon dioxide and water also require treatment.

Parameters of the biogas composition were analysed by the “Omnisfera” company Chemical analysis of the biogas sample of the EKODOLINA landfill is presented in Tab. 3.

Tab. 3. LFG parameters in EKODOLINA (13)

Parameter	Unit	Value	Error of measurement
Temperature	°C	21.5	0.1
Relative humidity	%	62.7	-
Density	kg/m ³	0.83	-
Methane	%Vol	43.3	4.3
Carbon dioxide	%Vol	31.1	3.1
Oxygen	%Vol	2.0	0.3
Hydrogen	%Vol	0.0034	-
Nitrogen		8.92	-
Carbon monoxide	ppm	19	3
Hydrogen sulphide	%	0.1608	0.0053
Chlorine	mg/m ³	94.83	28.45
Oil moisture	mg/m ³	0.1	
Siloxanes	mg/m ³	0.859	0.301
Silicon	mg/m ³	0.314	0.110
Sulphur	mg/m ³	2605	859
Ash PM10	mg/m ³	0.03	-

As can be seen from the sample, the landfill gas is highly sulphated. Sulphur has a largely negative impact on all components of the technological line as well as on cooperating devices. The engines fail frequently because of sulphur as it reacts with all metal parts and the engine oil, significantly reducing the lubricating property of the oil. This, in turn, damages other components and causes a domino effect. Exhaust valves get damaged first. Due to the sulphur deposits on the valve plug and stem, the geometry of the valve is changed (17). Short-term prediction of changes in the gas composition as a function of raw material supply for its production and weather conditions would enable better control of engine operation.

The process of obtaining biogas is very simple. Through uniformly spaced gas wells that have an impact radius of 15 m, gas is collected into common collectors. Fig. 2 gives an example of the construction of a degassing well has been presented.

Through Φ 12-mm pores and drainage backfilling from 16 -to 32-mm gravel, biogas gets collected into a Φ 160-mm pipe. The drainage pipe collects gas throughout the depth of the landfill. By doing so, it has only been possible to build a well comprising a 15-m-deep layer of waste. The landfill itself was closed with an average waste depth of 25 m. To make the wells most effective, it was decided to raise wells. This construction proved to be unfavourable due to the deposit's topography. The site should be treated as morphologically unstable. This indicates that displacements and settlements occur inside, which irreversibly affects drainage; causes displacement, crushing and splitting at particular heights of collecting pipes; and limits the flow from the gas collection pipe to the drains towards the collecting stations. Leads are called connection collectors, and they run towards collecting stations.

In addition to vertical wells, it should be noted that horizontal drainage can also be carried out in a similar way. The horizontal wells exactly play the same role and help limit the release of biogas into the atmosphere. The system involving the two types of wells is more effective, thus doubling its functioning, as well as its efficiency and flow increase. This has a measurable effect in reducing the negative pressure that exists in the entire network. There are 150 wells in the plant, including 75 in the old site of the landfill and 40 in the new site. These are all connected to two main collectors that transport biogas to engines.

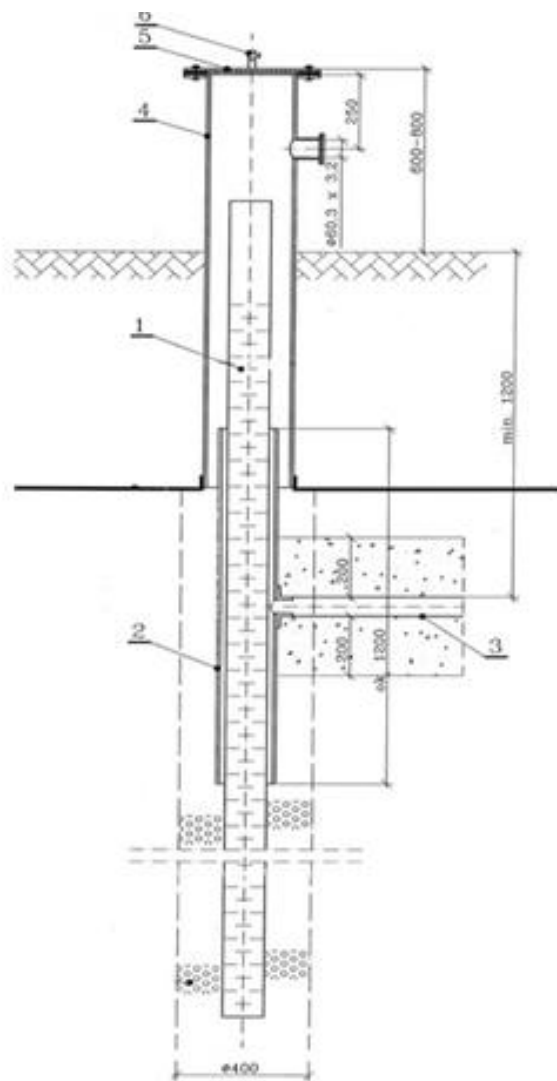

Fig 2. LFG well 1 - drainage pipe, 2 - casing pipe, 3 – water drainage pipe, 4 - degassing chimney 5 – cover, 6 – connection fitting (13)

The biogas intake network system includes the following:

- collective stations for individual water bodies with A (rich)/B (poor) gas selection,
- deep water intakes defined as gas wells,
- well connections to collecting stations made of PE Φ 63 SDR 110,
- transmission collectors for a technological building – a two-wire parallel system,
- drainage systems for gravity and pump networks and
- automatic biogas suction and pressure station.

From the storage sites, the collected biogas is first transported through collectors to the collective station, the construction of which is shown in Fig. 3.

The biogas is delivered to the compressor through two main pipelines. Drainage wells are installed along the entire length of the pipelines where the levels are broken. Due to the high moisture content of biogas and the differences in temperature inside the deposit in relation to the temperature prevailing in the collecting stations and the pipelines, the condensate precipitates. To prevent clog-ging, pipelines should be discharged at the lowest points. An example of such a well is shown in Fig. 4.



Fig. 3. Connection of gas wells to main pipelines (13)

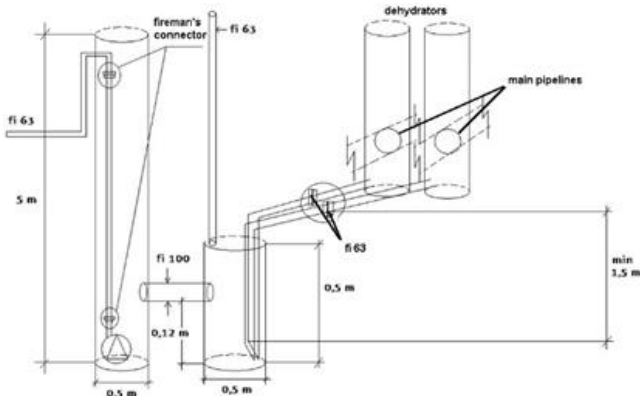

Fig. 4. Construction of a drainage well for the main gas pipelines (13)

The landfill gas flow rates and its chemical composition as well as weather conditions were registered at the ECODOLINA landfill. Existing equipment installed for monitoring the operation of the gas utilization system was used. The registered data were used to model the landfill gas generation in this study.

4. RESULTS OF THE MEASUREMENTS

The amount of landfill gas generated in the system is the source of electrical energy and thermal energy. The LFG and total energy production are presented in Fig. 5. Fig. 5 presents the streams of sucked gas registered in January 2018–December 2018.

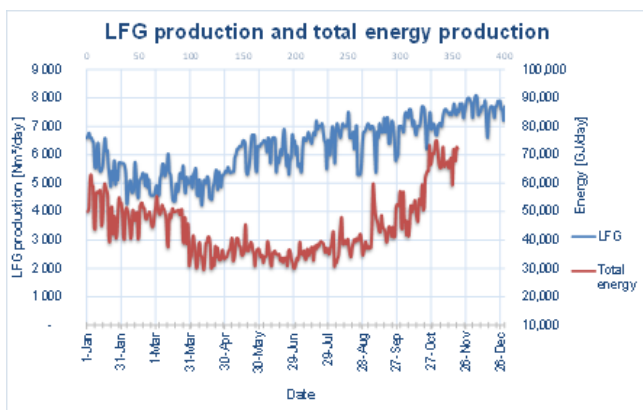

Fig. 5. LFG and total energy production in 2018

The total amount of energy produced in cogeneration increases during the heating season due to the use of thermal energy. Changes in the amount of energy produced over time, with greater amplitudes than changes in gas production in a landfill, result from fluctuations in the calorific value of landfill gas. These fluctuations are shown in Fig. 6. The largest changes were observed in August and September, which contributed to the enormous changes in energy production.

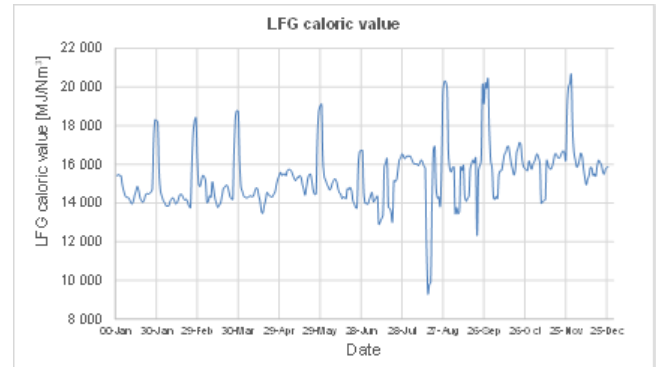

Fig. 6. LFG calorific value over the time in 1 year

The aim of this study was to discover the relationship between atmospheric conditions and LFG production. After changing the ambient temperature, the heating or cooling of the sites at the landfill takes place slowly. This is typical of the old, enclosed quarters. They have a layer of soil insulating from the environment, and before the heat penetrates this layer, gas production does not change. While working on the data recorded at the ECODOLINA landfill, the time shift when considering the effect of temperature is 1 week. To illustrate the process of gas production based on temperature, the charts shown in Fig. 7 were prepared. The graphs presented in the charts take into account the 1-week delay of the change in the production of landfill gas in relation to the moment of the temperature change.

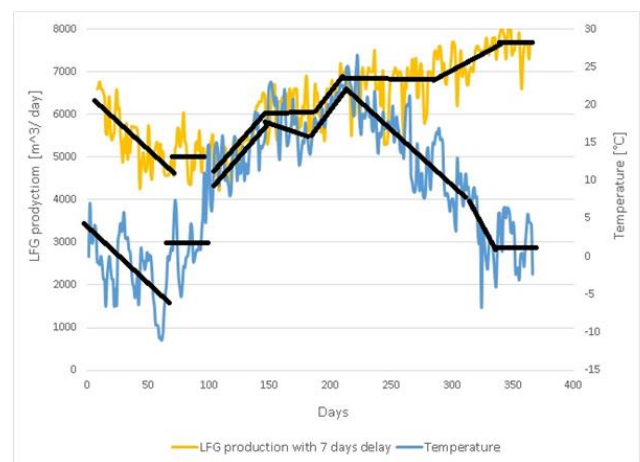

Fig. 7. LFG production (with 7 days delay) – yellow line and ambient temperature on the landfill area – blue line. 0 on the abscissa represents the first day of 2018

The analysis of the graphs plotted for the whole year allows drawing the following conclusions. The calendar year is divided into periods:

- the landfill sites heat up from the surroundings;
- they are in thermal equilibrium with the surroundings; and
- they are cooled by the surroundings.

After reaching sufficient temperatures for the development of methanogenic bacteria (in our measurement, 24°C ambient air), an increase in ambient temperature does not increase the production of landfill gas.

During summer, and more specifically from April 1 to July 30 (from 90th to 212th day of the year), landfill gas production is correlated with ambient temperature. After summer, the microbial population is so high that gas production in the sites is constant or even increases significantly regardless of the ambient temperature decrease at that time. Constant production is maintained by saturating the bed with bacteria, and in the absence of new food, their number does not increase. However, the decrease in temperature worsens living conditions of the old and the new bacteria that have multiplied and began their work. During winter, until a critical point at the turn of the year, production is stable due to the sufficient microbial population maintained in the bed.

We noted the following relationships between the amount of gas produced and the ambient temperature:

- Analysis of the temperature changes 1 week in advance to calculate the actual gas production
- An increase in ambient temperature results in an average directly proportional increase in gas production until the ambient temperature reaches 24°C.
- After 24°C is reached, methane production becomes constant.
- With a slow temperature drop, the production remains constant due to the heat accumulated in the landfill and a large microbial population. This phenomenon can last for even 50 days.
- Only a temperature drop to below 5°C causes a directly proportional decrease in methane production.

The gas production dynamics can be described using time to predict future changes in production, relative to the change in temperature, which is mostly rising during the summer season. This 100-day seasonal change is shown in the graph in Fig. 8.

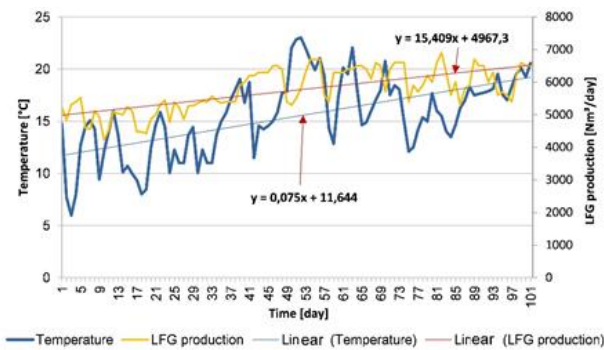

Fig. 8. Illustration of the dynamics of the process during summer season (100 days)

The derivative of the temperature as a function of time dT/dt is 0.07 [°C/day], and the derivative of the daily gas production dQ/dt is 15.4 [Nm³/day].

We propose a method to predict the amount of gas produced in a current week based on the average ambient temperature in the period of time including previous 10 days. Since the relationships between the velocities turned out to be logarithmic, it is

possible to formulate an algorithm for planning the amount of gas produced in summer, knowing the temperatures in the past. Different periods were tested for LFG production prediction, but the 10-day period seems to be the most suitable time. Various tested periods for the process are shown in Fig. 9.

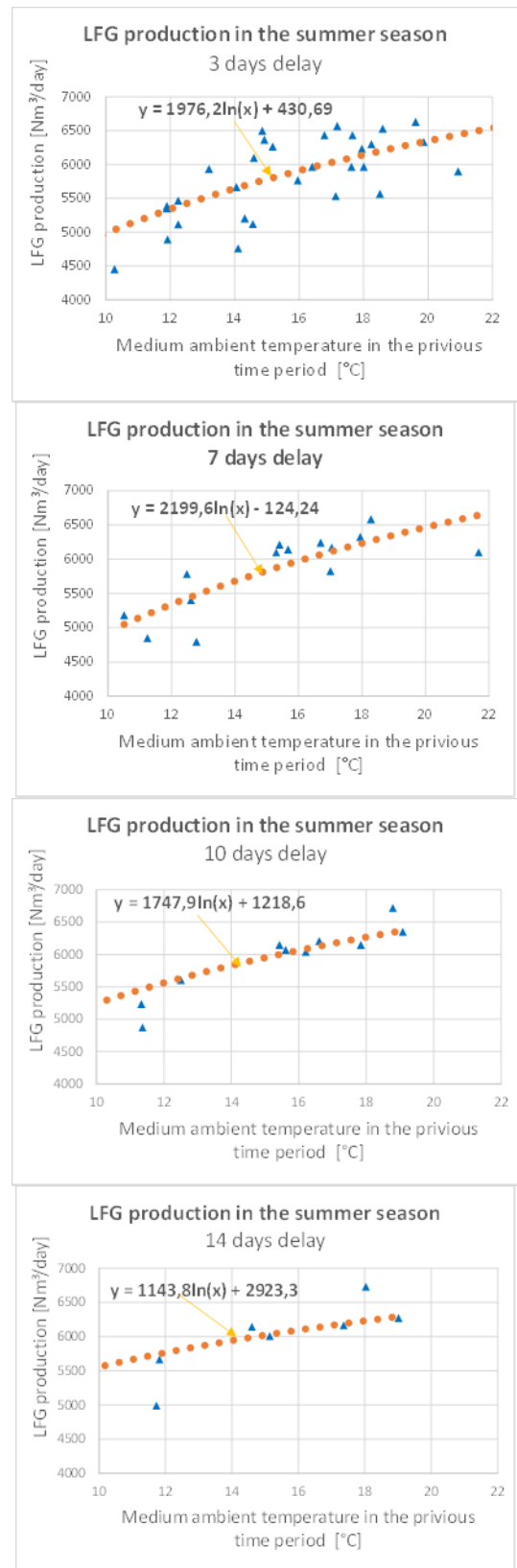

Fig. 9. LFG production model verification process for several days of the observation process

The algorithm for calculating the future gas production in the summer season is shown in Fig. 11. Fig. 10 shows Correlation coefficient between model formula and experimental data.

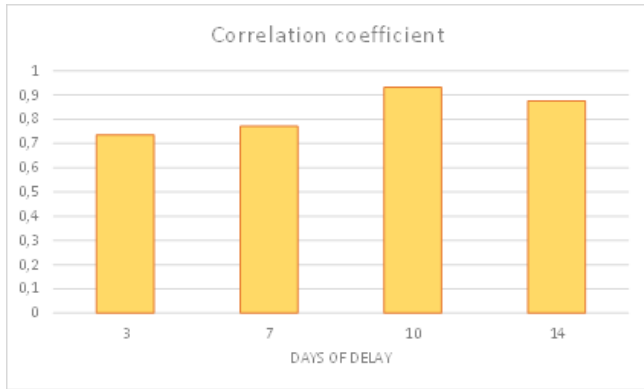

Fig. 10. Correlation coefficient between model formula and experimental data

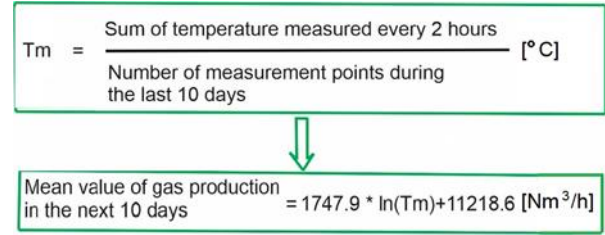

Fig. 11. Algorithm for calculating the future gas production in the summer season

The aforementioned remarks should be used in planning the process of using landfill gas for energy production.

A previous study (14) showed that changes in the methane content in biogas follow atmospheric pressure changes. Changes in the methane content depending on atmospheric pressure are analysed. After changing the atmospheric pressure upwards, the methane content in the landfill gas begins to increase with a 2-day delay. This situation is related to the volatility of the methane-carbon dioxide mixture. Methane is less dense than air and carbon dioxide and is more dense than air.

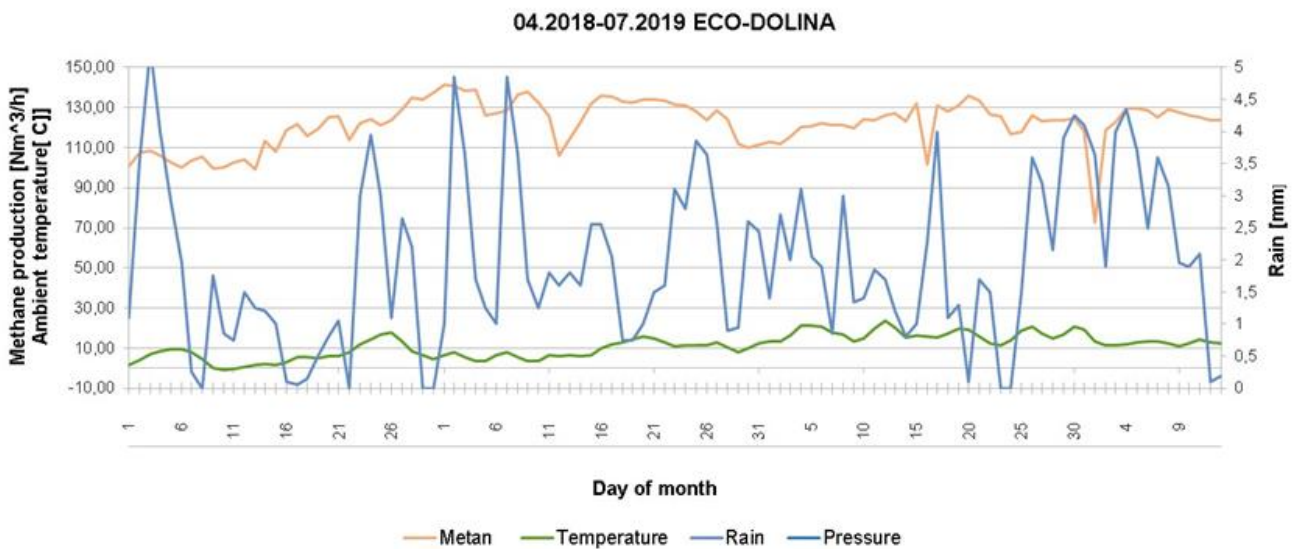

Fig. 12. Production of methane in relation to the intensity of rainfall and ambient temperature

Probably, during periods of higher pressure, the atmospheric part of carbon dioxide is not pulled out of the well (prisms) by the system suction of biogas, which results in obtaining biogas with a higher methane content. If atmospheric pressure decreases, carbon dioxide quantity increases, causing the reduced methane content. No statistically significant correlation was found in the effects of barometric pressure on LFG quality in wells. (15) (16) (16).

The current trend leads towards landfill bioreactor technology (LBT) systems, which augment the amount of water contacting the waste to stabilize it rapidly. This technique can produce large initial LFG generation rates, which will decrease sharply after a few years.

Rainfall is conducive to the production of landfill gas; a previous study (17) found that the methane generation coefficient k increases with a wet bed from 0.02 to 0.065. The authors put forward a similar conclusion, observing the increase in methane

production in the diagram shown in Fig. 12. The winter months of 2018 were dry, while the spring months of 2019 were rainy, which affected the amount of methane produced.

The effect of rainfall is significantly lower during the summer season than during winter.

5. SUMMARY

There are difficulties in taking into account many factors affecting landfill gas production. Weather phenomena can change quickly. For example, in Poland, temperature drops by 28° have been recently recorded. Rapid temperature changes do not affect the amount of LFG produced immediately. The effect of temperature changes is only visible after approximately 10 days. After a long period of summer temperatures, the amount of live methane bacteria is sufficient and gas production does not increase with

increasing temperature. Due to the high heating effect of the landfill site in the summer, the production of the LFG maintains a high level in winter.

After testing various periods of several days of taking into account the effect of temperature on gas production, a 10-day observation period was selected.

Since the relationships between the velocities turned out to be linear, it is possible to formulate an algorithm for estimating the amount of gas produced in summer, based on the derivative of the temperature change in the last 10 days.

The impact of atmospheric pressure was more evident in gas production, after 2 days or 3 days.

There was no clear correlation between the amount of rainfall and the production of landfill gas.

This work contributes to building short-term mathematical models of landfill gas production. The developed model could be used to control the operation of a cogeneration heat and power CHP plant, such as preparations for switching on further power generators to increase the efficiency of energy production.

REFERENCES

1. EPA. Municipal Solid Waste Landfills What is a Municipal Solid Waste Regulations for Municipal Solid Waste Landfills Publications and Guidance for Municipal Solid Waste [Internet]. 2023. Available from: <http://epa.gov/landfills>
2. European Council. Directive 2010/75/EU Industrial Emissions. Off J Eur Union [Internet]. 2010;L334:17–119. Available from: http://europa.eu/legislation_summaries/environment/air_pollution/ev0027_en.htm
3. Van Dingenen R, Crippa, M. J, Anssens-Maenhout G, Guizzardi D, Dentener F. Global trends of methane emissions and their impacts on ozone concentrations. Vol. EUR29394EN, JRC Science for Policy Report. 2018.
4. Sarptaş H, EKER S, Seyfioglu R, Boyacioglu H, Dolgen D, Alpaslan N. Models for the Prediction of Landfill Gas Potential – A Comparison. 2012.
5. Benato A, Macor A. Italian biogas plants: Trend, subsidies, cost, biogas composition and engine emissions. *Energies*. 2019;12(6): 1–31.
6. Vakalis S, Moustakas K. Applications of the 3T method and the R1 formula as efficiency assessment tools for comparing waste-to-energy and landfilling. *Energies*. 2019;12(6):1–11.
7. Barlaz MA, Chanton JP, Green RB. Controls on landfill gas collection efficiency: Instantaneous and lifetime performance. *J Air Waste Manag Assoc*. 2009;59(12):1399–404.
8. Meres M, Szczepaniec-Cieciak E, Sadowska A, Piejko K, Szafnicki K. Operational and meteorological influence on the utilized biogas composition at the Barycz landfill site in Cracow, Poland. *Waste Manag Res*. 2004;22(3):195–201.
9. Manyuchi MM, Mbohwa C, Mpeta M, Muzenda E. Methane generation from landfill waste as a resource recovery strategy. *Proc Int Conf Ind Eng Oper Manag*. 2019;2019(MAR):200–24.
10. Negm AM, Shareef N. *Waste Management in MENA Regions*. Springer Water Ser. 2019;(June).
11. Mahar RB, Sahito AR, Yue D, Khan K. Modeling and simulation of landfill gas production from pretreated MSW landfill simulator. *Front Environ Sci Eng*. 2016;10(1):159–67.
12. IPCC. 2006 IPCC Guidelines for National Greenhouse Gas Inventories: Vol 5 Chapter 3 Solid Waste Disposal. 2006 IPCC Guidel Natl Greenh Gas Invent [Internet]. 2006;4:6.1-6.49. Available from: <http://www.ncbi.nlm.nih.gov/pubmed/20604432>.
13. Handrzyński J. Design of modification of control system of engines powered by biogas fuel, diploma thesis. Polish Naval Academy; 2015.
14. Zi M, Kropiwnicki J. Identification analysis of dynamic changes in the composition of biogas and their impact on the operation of internal combustion engines. 2011;1–6.
15. LMOP. Landfill Gas Energy Basics Landfill Gas Modeling Project Technology Options Project Economics and Financing Landfill Gas Contracts and Regulations Best Practices for Landfill Gas Collection System Design and Installation Best Practices for Landfill Gas Co. 2021.
16. Czepiel PM, Shorter HR, Mosher B, Allwine E, McManus JB, Harriss R, et al. The influence of atmospheric pressure on landfill methane emissions. *Waste Manag*; 2003.
17. Leone J. The Effects of Atmospheric Pressure Changes on Landfill Gas Collection Efficiency and Quality. 2007.

Zbigniew Kneba:  <https://orcid.org/0000-0002-6956-2330>

Jacek Kropiwnicki:  <https://orcid.org/0000-0001-7412-7424>