

## HAZARDOUS GASES DETECTION BY FLUCTUATION-ENHANCED GAS SENSING

Mateusz M. Kotarski, Janusz M. Smulko

*Faculty of Electronics, Telecommunications and Informatics, Gdańsk University of Technology,  
Gdańsk, Poland, [jmulko@eti.pg.gda.pl](mailto:jmulko@eti.pg.gda.pl)*

Gas sensing can be enhanced by observing resistance fluctuations in Taguchi Gas Sensors. Unfortunately, fluctuation measurements need advanced measurement setups. This paper presents a possibility of fluctuation-enhanced gas sensing that can be utilized in a simplified and cheap gas sensing system. A detailed study has been conducted for two hazardous gases: ammonia (NH<sub>3</sub>) and hydrogen sulfide (H<sub>2</sub>S) using TGS 826 and TGS 825 resistance sensors. The research was focused on practical application of gas detection by resistance fluctuations for the selected harmful gases. Repeatability of noise measurements was investigated to establish rules for most reliable gas detection by a single gas sensor.

*Keywords:* fluctuation measurements; gas sensors; enhanced gas sensing.

### 1. Introduction

Commonly used gas sensors such as Taguchi Gas Sensors (TGS) utilize DC resistance changes for detection of various gases that are present in their ambient atmosphere. The sensors comprise a gas sensing layer of SnO<sub>2</sub> heated to the elevated temperature. The layer exhibits low conductivity in clean air, which increases in gas, depending on gas concentration. In this paper it is considered how to detect ammonia (NH<sub>3</sub>) and hydrogen sulfide (H<sub>2</sub>S) using only a single gas sensor of type TGS 826 or TGS 825 (Fig. 1). Despite the fact that the sensor TGS 825 is optimized to detect hydrogen sulfide and TGS 826 to detect ammonia, both of them show similar DC resistance response in presence of these harmful gases. In presence of alkaline gas (NH<sub>3</sub>) the DC resistance decreases slightly (approx. 20% for 20 ppm of NH<sub>3</sub>). The acid gas (H<sub>2</sub>S) induces a more significant resistance decrease (approx. 80% for 20ppm of H<sub>2</sub>S). Such DC resistance responses create a problem with gas detection because the same change of DC resistance can be induced by a respectively large amount of NH<sub>3</sub> or a small amount of H<sub>2</sub>S.

It is known that gas adsorption processes on porous semiconductor surfaces, such as used in TGS sensors, may result in changing electrical properties of the surface [1, 2]. These changes are observed as resistance fluctuations and can be utilized as a source of information for improving the sensitivity and selectivity of gas detection by a single gas sensor [3–7]. Fluctuations usually are analyzed by power spectral density estimation, that means application of the FFT algorithm for low-frequency noise [8, 9]. However, the popular gas detection system should be cheap and therefore has to be based on a microcontroller which has limited computing power. Thus, we should apply some more simplified methods which can substitute power spectral density. This paper explores possibilities of detection and distinguishing between two harmful gases commonly present in industry and food production: ammonia (NH<sub>3</sub>) and hydrogen sulfide (H<sub>2</sub>S), using fluctuation-enhanced sensing.

---

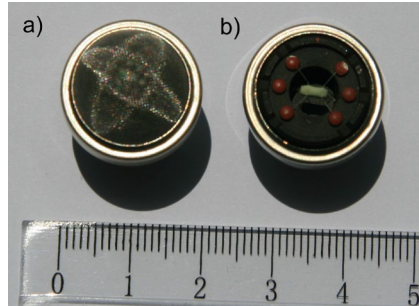

Fig. 1. Taguchi gas sensor (TGS) produced by the Figaro company: (a) purchased sensor TGS 826, (b) uncovered gas sensitive layer placed on a tube with an inside heater and contacts.

## 2. Measurement setup

In this exploratory study we present measurement results obtained by placing a gas sensor into a gas chamber and applying a low noise electronic circuit. The gas sensor was located in ambient atmosphere of synthetic air and calibrating gas, whose flow was controlled by a flow-meter. The AC voltage across the sensor, polarized by an adjustable DC voltage, was amplified by a low noise voltage amplifier using a JFET transistor (2SK170) and having a voltage gain  $K=200\div 800$  V/V [10]. The batteries were applied to polarize the gas sensor and to supply voltage to the low noise amplifier. The DC voltage component across the sensor was measured by applying an additional RC low pass filter that comprised a capacitor  $C$  and resistor  $R$ , its resistance being a few orders greater than the sensor resistance  $R_s$ . The voltage across the gas sensor was adjusted by a potentiometer which was joined to a series connection of TGS sensor and a resistor  $R_I=11$  k $\Omega$  having similar resistance as the gas sensor (Fig. 2). The potentiometer was supplied from a battery and had an additional capacitor at its output to reduce noise.

The amplified AC voltage was measured by a Stanford SR760 spectrum analyzer. Such measurement setup was applied to establish a frequency range where the  $1/f$  noise component dominates. Then we can apply a much simpler analysis using only a cheap A/D converter that samples a voltage signal in the acoustic frequency range and estimates its variance:

$$\sigma_u^2 = \frac{1}{N-1} \sum_{i=1}^N u^2(t_i) \quad (1)$$

that requires only multiplication  $u(t_i) \cdot u(t_i)$  of the sampled zero mean voltage signal ( $i=1,2,\dots,N$ ), summation and finally normalization by a factor  $1/(N-1)$ . This suggested solution does not require expensive anti-aliasing filters and can be based on popular A/D converters that are part of contemporary microcontrollers or are commonly used in audio or portable electronics and assure a signal sampling frequency even up to 96 kHz and 24-bits resolution. The proposed computations are simple enough to be performed by a cheap microcontroller and additionally do not require too much memory [11].

## 3. Experimental results

DC resistance and its fluctuations were observed in both types of the investigated sensors (TGS 825, TGS 826). The selected sensors are optimized to identify  $H_2S$  (TGS 825) or  $NH_3$  (TGS 826) by applying different elevated temperatures of gas sensitive layer  $SO_2$  or

by adding some additives. Nevertheless, both types exhibit a DC resistance change at presence of both gases.

Power spectral density of voltage fluctuations across the sensor was proportional to a the square of the sensor DC voltage ( $U_{DC}$ )<sup>2</sup> as predicted by Hooge 1/f noise formula (Fig. 3) [12]. This proves that the applied system measures gas sensor resistance fluctuation in the low frequency range that are not overwhelmed by other noise sources (e.g. inherent noise of measurement system), independent on  $U_{DC}$ . This dependence was observed at least up to 10 kHz and for  $U_{DC} \geq 0.5V$ . Such conditions mean that the measurement system can be easily adapted into a cheap, commercial version.

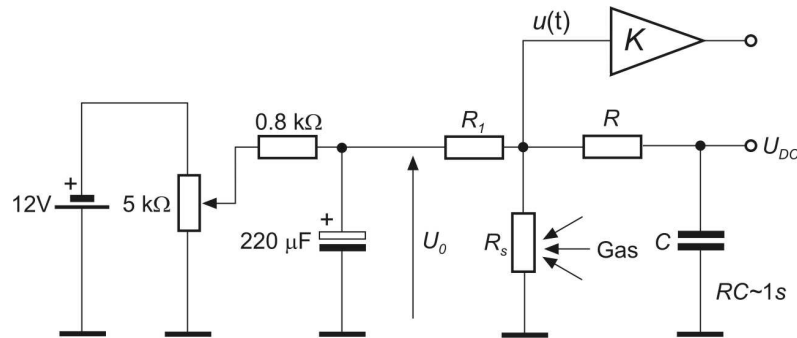

Fig. 2. Measurement setup for the proposed enhanced gas sensing

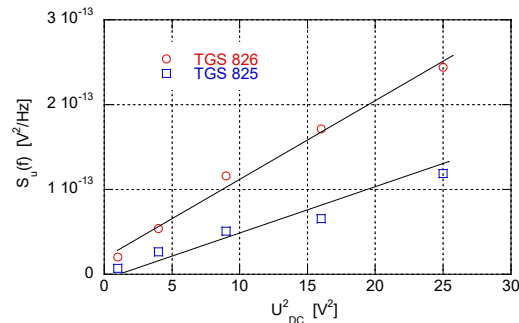

Fig. 3. Power spectral density of voltage fluctuations  $S_u(f)$  in gas sensor TGS825 and TGS826 versus squared DC polarization voltage ( $U_{DC}$ )<sup>2</sup> at a frequency of  $f=1$  kHz and in ambient atmosphere of synthetic air.

### 3.1. Measurements of TGS 826 gas sensors

Figure 4 plots the normalized power spectral density of voltage fluctuations across the polarized TGS 826 sensor in ambient atmosphere of  $NH_3$  or  $H_2S$  diluted in synthetic air. The 1/f noise component dominated up to 12 kHz. Its intensity has increased at higher concentrations of  $H_2S$ . There was almost no change of 1/f noise at various concentrations of  $NH_3$ .

Before noise can be used as an indicator of various gas presence, we should assess the repeatability of the estimated noise parameters. Figure 5 shows results observed for the TGS 826 sensor in ambient atmosphere of ammonia. These three plots correspond to consecutive measurements:

- initial measurement (A),
- taken after 20 minutes (B),
- taken the day after (C).

The observed random error of the estimated power spectra, by averaging over 200 separate spectra, was close to the expected random error. That result confirms sufficient repeatability of noise data and usefulness of noise measurements for gas detection.

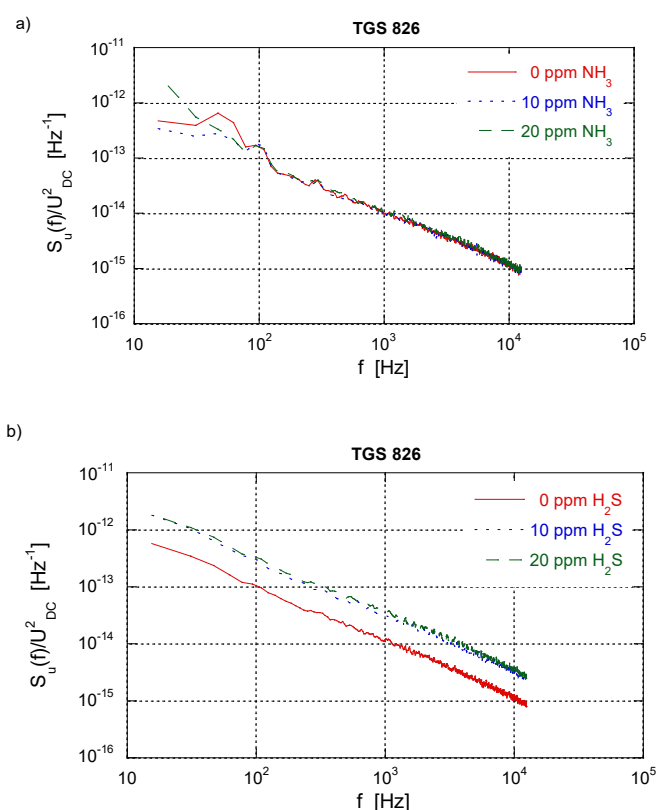

Fig. 4. Power spectral density  $S_u(f)$  of voltage fluctuations across the gas sensor TGS 826 normalized to the squared sensor DC voltage ( $U_{DC}^2$ ) at ambient atmosphere of synthetic air mixed with: (a) ammonia ( $NH_3$ ) or (b) hydrogen sulfide ( $H_2S$ ) at various concentrations.

Additionally, it has been investigated how the noise level observed in the same conditions varies between sensors of the same type. Figure 6 shows measurement results observed for two, randomly chosen, TGS 826 sensors. We conclude that the  $1/f$  noise level is an individual feature of the sensor that is also experimentally observed in other semiconductor materials [14]. The reproducibility results of noise measurements is similar to that reported earlier for  $NH_3$  gas (Fig. 5). Noise intensity is characterized by the power spectrum at a frequency of 1 kHz. It is clear that a wider bandwidth will result in higher data reproducibility and shorter measurement time. We suppose that a combination of noise measurements and DC resistance can result in a parameter that unambiguously detects both hazardous gases by employing only one TGS 826 gas sensor.

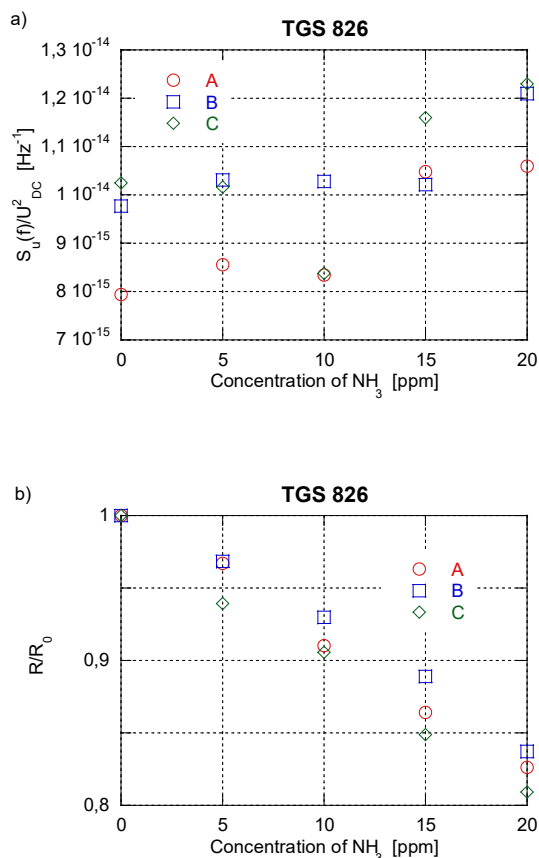

Fig. 5. Repeatability of the gas sensor TGS 826 noise measurements at ambient atmosphere of synthetic air mixed with ammonia (NH<sub>3</sub>): (a) power spectral density  $S_u(f)$  of voltage fluctuations across the gas sensor normalized to the squared sensor DC voltage  $(U_{dc})^2$  across the sensor at frequency 1 kHz, (b) its DC resistance  $R$ .

### 3.2. Measurements of TGS 825 sensors

The sensors TGS 825 were also investigated to detect the presence of H<sub>2</sub>S and NH<sub>3</sub> gases. The recorded voltage fluctuations exhibited a 1/f noise component at least up to 12 kHz. The power spectrum of 1/f noise increased with gas concentration for both hazardous gases H<sub>2</sub>S and NH<sub>3</sub> (Fig. 7). The changes observed in the presence of H<sub>2</sub>S were similar to those registered for the TGS 826 sensor. A novelty of the TGS 825 sensor is the small change of noise at ambient atmosphere of NH<sub>3</sub> (Fig. 7a) that was not observed for the TGS 826.

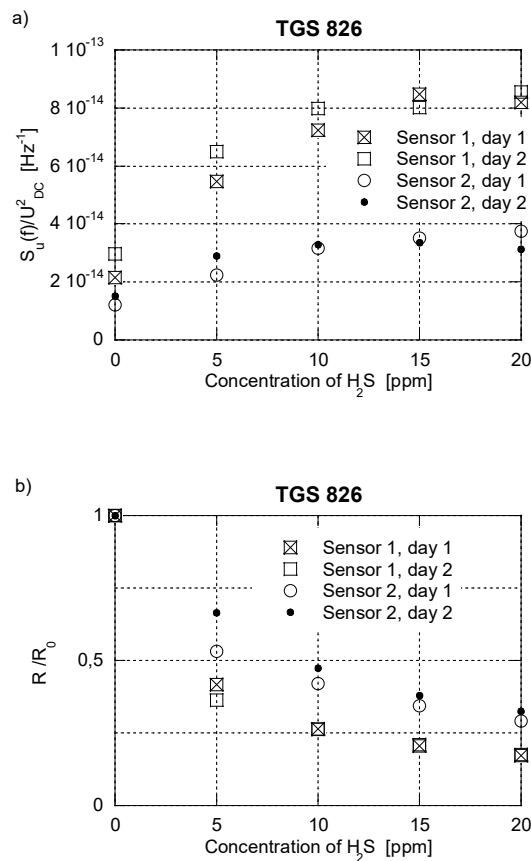

Fig. 6. Measurements of gas sensors TGS 826 at ambient atmosphere of synthetic air mixed with hydrogen sulfide (H<sub>2</sub>S): (a) power spectral density  $S_u(f)$  of voltage fluctuations across the gas sensor TGS 826 normalized to the squared DC voltage ( $U_{DC}$ )<sup>2</sup> across the sensor at frequency 1 kHz, (b) its DC resistance  $R$ ; the measurements were repeated for two sensors (sensor 1, sensor 2) within two consecutive days (day 1, day 2).

The measurements were repeatable in the same way as for the gas sensors TGS 826. We observed differences between the consecutive measurements of a few percent only. That variation can result from stability of gas flow meters and time of noise data averaging. Thus we conclude that this sensor can be also utilized to detect the investigated hazardous gases. Unfortunately, an increase of 1/f noise in presence of NH<sub>3</sub> would certainly limit the efficiency of these gases' detection by a single TGS 825 sensor when compared with the TGS 826 sensor which does not exhibit such changes. This conclusion results from a smaller change of noise intensities observed for TGS 825 sensor than for TGS 826 sensor at two ambient atmospheres of NH<sub>3</sub> and H<sub>2</sub>S. For example, TGS 826 sensor exhibits at 1 kHz the difference of  $S_u(f)/U_{DC}^2$  between 20 ppm of NH<sub>3</sub> and 20 ppm of H<sub>2</sub>S equal to 3.1 (Fig. 4), whereas the TGS 825 exhibit the difference of 2.2 at the same conditions (Fig. 7). The smaller difference means lower probability of proper gas detection.

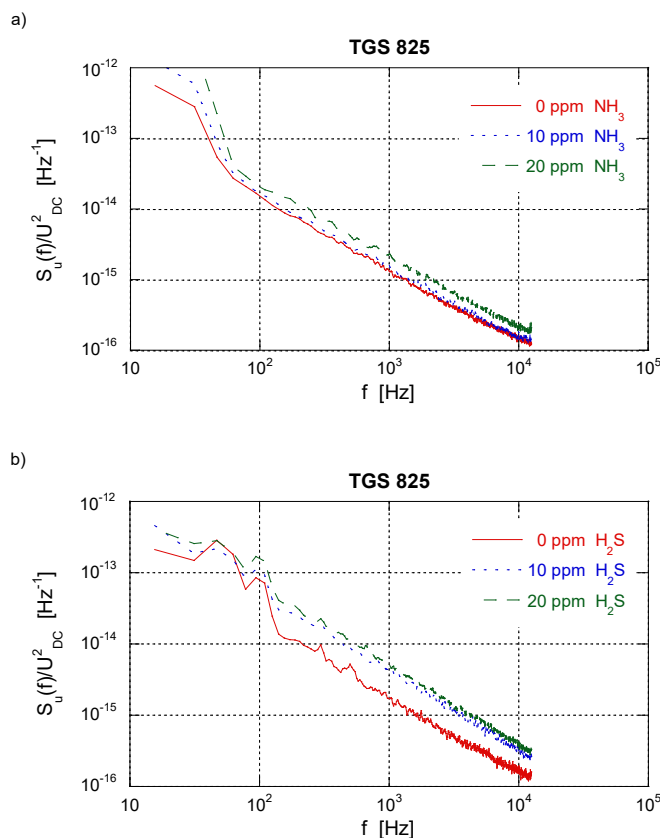

Fig. 7. Power spectral density  $S_u(f)$  of voltage fluctuations across the gas sensor TGS 825 normalized to the squared DC voltage  $(U_{DC})^2$  across the sensor at ambient atmosphere of synthetic air mixed with: (a) ammonia ( $NH_3$ ) or (b) hydrogen sulfide ( $H_2S$ ) at their various concentrations.

#### 4. Gas detection methods

The main aims of the presented measurements were to recognize the repeatability of noise data and their potential use in practice and to propose a parameter of gas detection which will contain information about the sensor DC resistance together with intensity of voltage fluctuations and will not require complicated computing that cannot be performed by a cheap microcontroller. Therefore, we investigated two independent proposals to establish which assure effective gas detection and can be easily introduced in practice.

The first one is a parameter  $G_1$  defined as a normalized quotient of the DC resistance  $R$  and power spectral density  $S_u(f)$  of voltage fluctuations across the polarized sensor. In order to standardize  $G_1$  values, we used the sensor DC resistance and power spectral density divided by the squared DC voltage  $(U_{DC})^2$  across the sensor and normalized to the same quotient but observed at ambient atmosphere of synthetic air (s.a.) only:

$$G_I = \frac{R / \frac{S_u(f)}{U_{DC}^2}}{\left( R / \frac{S_u(f)}{U_{DC}^2} \right)_{s.a.}} \quad (2)$$

The exemplary values of  $G_I$  estimated for the investigated types of gas sensors are shown in Figure 8. The curves are different for both gases. The sensor TGS 826 exhibits stronger differences in  $G_I$  between both gases than TGS 825 (Fig. 8). The identified differences in  $G_I$  can improve gas detection. Unfortunately, the parameter  $G_I$  cannot resolve unambiguously which gas is present when only a single gas sensor is used because the same  $G_I$  value is observed for both gases but at their different concentrations.

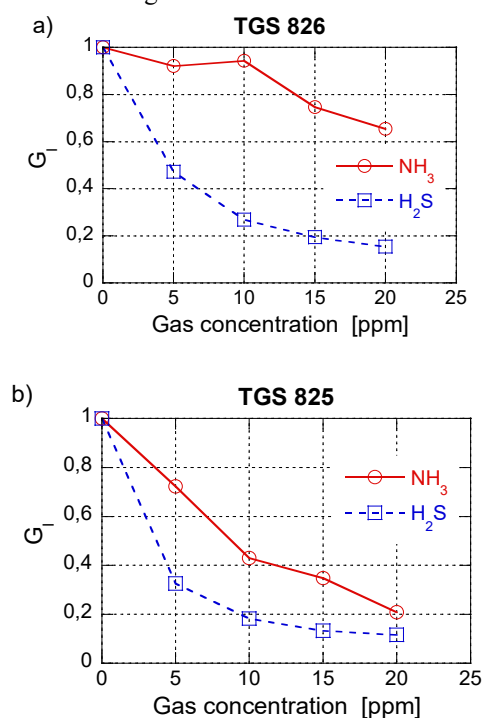

Fig. 8. Gas detection parameter  $G_I$  estimated as a quotient of DC sensor resistance  $R$  and power spectral density  $S_u(f)$  of voltage fluctuations at 1kHz divided by a square of DC voltage  $(U_{DC})^2$  across the sensor; the parameter  $G_I$  was normalized to a value observed in the atmosphere of synthetic air.

Therefore, the second method was proposed that could distinguish between the investigated gases by applying only a single gas sensor and plain computing. This method bases on sampling voltage fluctuations across the sensor that was placed in a series connection with a resistor of similar resistance as the investigated sensor (Fig. 2). The DC voltage  $U_{DC}$  across the sensor and amplified fluctuations  $u(t)$  are measured by two A/D converters.

The power spectral density  $S_u(f)$  of voltage fluctuations across the sensor in presence of various gases is affected by a change of noise intensity and additionally by a drop of





DC resistance at higher gas concentrations when the serial connection of two resistors is polarized by a stabilized  $U_0$  voltage:

$$S_u(f) = \frac{S_u(f)}{U_{DC}^2} U_{DC}^2 = \frac{S_u(f)}{U_{DC}^2} U_0^2 \left( \frac{R_s}{R_1 + R_s} \right)^2 \quad (3)$$

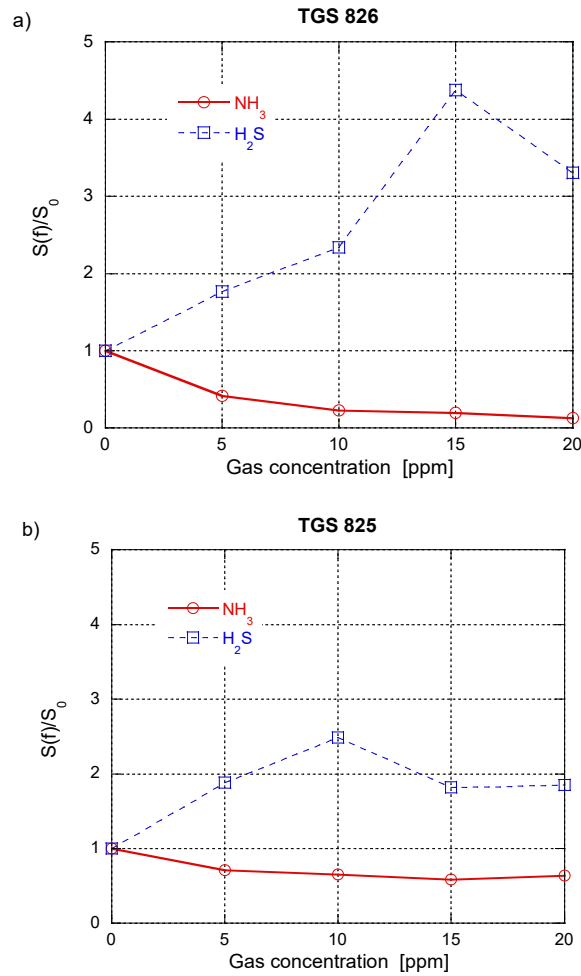

Fig. 9. Normalized power spectral density  $S_u(f)$  of voltage fluctuations across the sensor at 1kHz for: (a) TGS 826 and (b) TGS 825 sensors at various gas mixtures and concentrations; the sensor was placed in a series connection with a 11 k $\Omega$  resistor and polarized by adjoined stabilized voltage source  $U_0$ ;  $S_0$  – power spectral density of voltage fluctuations across the sensor at 1 kHz and in ambient atmosphere of synthetic air

Thus, the power spectral density  $S_u(f)$  depends on two factors:

- $S_u(f)/(U_{DC})^2$  that increases at different pace with gas concentration (Fig. 4b, Fig. 7b) or is practically constant (Fig. 4a) for the investigated gases and sensors,
- the quotient of gas sensor resistance  $R_s/(R_1+R_s)^2$ ; that quotient declines when  $R_1 \geq R_s$  at various gas concentrations.

Therefore, we can expect for some gas sensors that  $S_u(f)$  would change in a different way, increasing or decreasing, in the presence of the investigated toxic gases. Then,  $S_u(f)$  observed in a single gas sensor would detect which gas is present and the  $R_s$  value would determine the detected gas concentration. Figure 9 presents  $S_u(f)$  data observed for both types of investigated sensors at  $f = 1$  kHz. The difference of  $S_u(f)$  observed in presence of  $\text{NH}_3$  or  $\text{H}_2\text{S}$  at their concentrations of 5 ppm exceeds 4 for TGS 826 and 2.5 for TGS 825. This difference is sufficient to detect explicitly the presence of  $\text{NH}_3$  or  $\text{H}_2\text{S}$ . The observed discrepancy increases with higher gas concentration and makes detection more reliable.

The power spectral density  $S_u(f)$  in an established frequency bandwidth can be easily estimated by sampling amplified voltage  $u(t)$  (Fig. 2) at the output of a band-pass RC filter and averaging their squared values. Then, operation of sampling and plain computing by a cheap microcontroller can be used to determine which gas is present in the ambient atmosphere of a single gas sensor. We can expect decent gas detection even at a concentration of a single ppm.

## 5. Conclusions

Resistance fluctuations were observed in two types of gas sensors TGS 826 and TGS 825 at ambient atmosphere of two gases: ammonia and hydrogen sulfide. The presented data confirmed that plain measurements and data computing can be used to distinguish between both gases by applying only a single gas sensor. Both gases are highly toxic and dangerous for humans. Therefore, the proposed method is valuable and can be easily applied in cheap and popular gas detectors controlled by a microcontroller. Additionally, gas detection was established by applying voltage power spectrum at 1 kHz that is convenient due to little requirements for fluctuations measurements system and no distortions from power lines at that frequency.

The estimated power spectral densities were averaged over 200 spectra and required measurement time below 10 s which can be accepted in practice. The measurement time can be even shortened by estimating variance of voltage fluctuations within a wider frequency bandwidth and applying proper whitening filter [10].

We can expect reliable detection of  $\text{NH}_3$  and  $\text{H}_2\text{S}$  at their concentrations of a few ppm and in a short time. Both investigated gas sensors can be utilized for this aim but the TGS 826 would provide somewhat better detection than a TGS 825. The presented gas detection parameter  $G_1$  can be effectively used for gas detection at higher concentrations but needs more computations and ambiguously detect these gases at their lower concentrations.

## References

- [1] B. Weisz, *Effect of electronic charge transfer between adsorbate and solid on chemisorption and catalysis*, *J. Chem. Phys.* **21** (1953) 1531–1539.
- [2] M.J. Madou, S.R. Morrison, *Chemical Sensing with Solid State Devices*, Academic Press, San Diego (1989).
- [3] L.B. Kiss, C.G. Granqvist, J. Söderlund, *Detection of chemicals based on resistance fluctuation-spectroscopy*, Swedish patent, Ser. No.: 9803019-0; Publ. No.: 513148.
- [4] L. Kish, R. Vajtai, C. Granqvist, *Extracting information from noise spectra of chemical sensors: single sensor electronic noses and tongues*, *Sensors and Actuators B* **71** (2000), 55–59.
- [5] A.K. Vidybida, *Adsorption-desorption noise can be used for improving selectivity*, *Sensors and Actuators A* **107** (2003) 233–237.
- [6] Z.H. Mkhitarian, A.A. Shatveryan, V.M. Aroutiounian, et al, *Low-frequency noise in structures with porous silicon in different gas media*, *Physica Status Solidi* **4**, 6 (2007) 2063–2067.

- [7] V. Aroutiounian, Z. Mkhitarian, A. Adamian, C.G. Granqvist, L. Kish, *Fluctuation-enhanced gas sensing*, *Procedia Chemistry* **1** (2009) 216–219.
- [8] M.J. Beeson, *Fluctuations and Noise: The Ultimate Key to Understand Physics*, Springer, Berlin (1985).
- [9] K.L. Clark, *Flicker Noise Data Base*, eds. H. Gallaire and J. Winker, Plenum Press, New York (1973) 293–306.
- [10] M. Joliat, *Total elimination of 1/f noise from conventional MOS transistors*, *IEEE Trans. Electr. Dev.* **45** (1976) 753–764.
- [11] J.S. Bendat, A.G. Piersol, *Random Data Analysis and Measurement Procedures*, Wiley, New York, 2000.
- [12] F.N. Hooge, *1/f noise is no surface effect*, *Phys. Lett. A* **29** (1969) 139–140.
- [13] A. Konczakowska, *Quality and 1/f noise of electronic components*, *Quality and Reliability Engineering Int.* **13**, 3 (1995) 165–169.