

High Performance Super-Twisting Sliding Mode Control Using Adaptive Gains and Time Delay Estimation for a Maritime Autonomous Surface Ship (MASS)

Hossein Nejatbakhsh Esfahani, Rafał Szlapczyński, Hossein Ghaemi
Gdańsk University of Technology
Faculty of Ocean Eng. and Ship Technology

Abstract

This research addresses two kinds of problems related to trajectory tracking of a Maritime Autonomous Surface Ship (MASS): those caused by the time-varying external disturbances including winds, waves and ocean currents as well as those resulting from inherent dynamical uncertainties. As the paper shows, an accurate and robust controller can successfully deal with both issues. An improved Adaptive Super-Twisting Sliding Mode Control (AST-SMC) algorithm is proposed here as a robust adaptive strategy. In this strategy, in order to improve performance of the standard super-twisting approach, we apply adaptive gains and an underlying concept based on Time Delay Estimation (TDE). The critical role of TDE part in this algorithm is estimating the impact of disturbances and uncertainties on the MASS model. Super-Twisting Time Delay Estimation (ST-TDE) and Adaptive Super-Twisting Time Delay Estimation (AST-TDE) are utilized here for better effect. The proposed algorithm has been implemented in MATLAB / Simulink environment and tested in the course of extensive computer simulations. The results have shown that it significantly outperforms Conventional Super-Twisting (CST) algorithm in terms of the tracking errors, robustness, control efforts and transient response.

Keywords: MASS, Super-Twisting, Time Delay Estimation, Robust Adaptive Control

1. Introduction

In the maritime operations, the activities are commonly categorized in two divisions including surface and underwater operations and missions such as underwater explorations, inspection of the undersea structures, parameter measurement and maritime transportation. Nowadays, marine robotics is one of the paramount research areas in the maritime industries where numerous numbers of researchers, institutes and industries have presented kinds of these robots such as underwater robot, Autonomous Underwater Vehicle (AUV) and Autonomous Surface Vehicle (ASV). In a larger scale, it is named the Maritime Autonomous Surface Ship (MASS) which in terms of the autonomous transportation, the MASS has extremely been highlighted by researchers. Indeed, due to some rigorous functions and even unavailable zones in the ocean environment, human has been forced thinking to solve this problem. Today, using the maritime autonomous vehicles is impressively increasing and for having a safe platform there are kinds of control algorithms applied to the MASS. Meanwhile, in the face of unavoidable time-varying disturbances induced by the winds, waves and ocean currents upon or under the sea and inherent uncertainties in a marine vehicle dynamical model, a high-performance control approach is certainly required to tackle with

these perturbations. Nevertheless, robustness property in the control algorithms should be considered during the designing of controllers for marine robots in order to terminate a task and track a desired trajectory autonomously. Some related researches have been presented in which the robust strategies such as Sliding Mode Control (SMC) and Robust Model Predictive Control (RMPC) were adopted for control of underwater robots (Nejatbakhsh et al., 2015; Esfahani et al., 2014; Esfahani et al., 2013; Esfahani, 2019). Concerning surface robots, two control strategies for the path following goal of an autonomous marine vehicle were presented (Hung et al., 2018) in which the input constraints and disturbances caused by constant ocean currents were regarded. The first approach in this research was obtained by using a Lyapunov-based design strategy, while the second was developed by adopting a MPC algorithm. For tuning of gains in a PID controller, a self-regulator PID was designed (Jamalzade et al., 2016) whose coefficients have been adjusted by using some adaptive fuzzy rules. An adaptive robust control approach included a disturbance observer was proposed (Zhang, 2018) for the trajectory tracking of Unmanned Marine Vehicles (UMVs). Researchers in this work adopted an adaptive law to estimate and compensate the disturbance observer error. Finally, with Combining a nonlinear disturbance observer, dynamic surface control, and adaptive robust backstepping together, a dynamic surface adaptive robust controller was presented. An interesting work has been accomplished using the finite-time extended state observer-based distributed formation control for marine surface vehicles with input saturation and external disturbances. In this study, researchers proposed a novel algorithm for estimating the unavailable velocity measurements and external disturbances simultaneously. In this paper, the time-varying external disturbances induced by winds, waves and ocean currents are considered in the computer simulations (Fu and Yu, 2018). A Nonlinear Model Predictive Control (NMPC) was used for an Unmanned Surface Vehicle (USV) (Liu et al., 2013). This controller was adopted for an underactuated USV to track a desired trajectory using surge force and yaw torque as control inputs. However, the robustness issue for MPC has been yet regarded as a challenge in the control theory and many researchers have presented some approaches in order to design a robust nonlinear model predictive controller. In this paper a normal form of MPC was used without any discussion concerning its robustness. Also, the environmental disturbances including winds, currents and waves have not been considered in this work. A novel robust adaptive formation control scheme based on the Minimal Learning Parameter (MLP) algorithm and the Disturbance Observer (DOB) was presented (Lu et al., 2018). Indeed, by using the MLP algorithm, a remarkable descent in tunable parameters for the controller and DOB has been occurred which it was led to reduction of the online computational efforts greatly. An improved trajectory tracking controller based backstepping control algorithm combined with sliding mode control method was designed to address the trajectory tracking problem of an underactuated USV (J. Liu et al., 2016). An autonomous robotic boat was designed by the researchers (Wang et al., 2018) which they adopted a nonlinear model predictive control (NMPC) to tackle with the trajectory tracking problems. However, considering the uncertain nonlinearities stem from changing in inertia and drag matrices of the robotic boat was discarded. Indeed, the values of these matrices may change drastically when transporting people and goods. Other weakness of this work was neglecting the influences due to winds, waves and ocean current disturbances. Nevertheless, a robust NMPC should have been adopted against these perturbations. As an artificial intelligence-based robust control strategy a multi-layer neural network and adaptive robust techniques were incorporated by researchers in the design of the control system to preserve its robustness against uncertain nonlinearities and environmental disturbances which are induced by waves and ocean currents. This proposed approach efficiently compensated both parametric and non-parametric uncertainties including time-varying disturbances induced by waves, winds and ocean currents and a



saturated neural adaptive robust output feedback formation controller was designed to satisfy control objectives (Shojaei, 2016). Researchers (Liu et al., 2015) employed an adaptive sliding mode controller in which a hierarchical sliding mode was adopted to deal with the underactuation of the model, and neural network as an adaptive part was used for approximating the unknown nonlinear part in the dynamical model. In this way, the robustness of the proposed controller was strengthened, and the chattering phenomenon of sliding mode strategy was eliminated. In this study, the nonlinear damping terms of ship's model were considered which are neglected in many studies, and the time-varying disturbances were taken into account to test the robustness of the designed controller. Two kinds of MPC controllers were addressed (Zheng et al., 2014) including nonlinear MPC (NMPC), which solved a constrained multi-variable nonlinear programming problem, and linearized MPC (LMPC), which solved a constrained quadratic programming problem through on-line iterative optimization. In this work environmental disturbances (winds, waves and currents) were excluded. As efficient algorithms, the researchers (Sharma et al., 2014) evaluated two novel non-linear autopilot designs for MASS based on non-linear Local Control Network (LCN) and non-linear model predictive control approaches to establish their effectiveness in terms of control activity expenditure, power consumption and mission duration length under similar operating conditions. Indeed, these autopilot systems have been used to control the non-linear yaw dynamics of an unmanned surface vehicle named Springer in which yaw dynamics of the vehicle has been modelled using a multi-layer perceptron-type neural network. Simulation results in this study showed that the autopilot based on local control network method performed better for Springer. Thus, this article reported the application of two novel non-linear autopilot designs for the MASS. Some researches were carried out concerning adopting the higher order sliding mode algorithms such as super-twisting for control of the maritime autonomous robots (Valenciaga, 2014; Tanakitkorn et al., 2017). However, in most of studies, the robust approaches have been adopted for the trajectory tracking of an autonomous surface platform (Abdelaal et al., 2018; Yi et al., 2016; L. Liu et al., 2016; Sun et al., 2017; Liu et al., 2019; Huang et al., 2019). The sliding mode-based controllers have an inherent robustness and they have shown drastic results against uncertainties due to parameter variations and external disturbances. In accordance to these mentioned features of sliding mode controllers as well as kind of our autonomous platform which is extremely affected by the complexity disturbances and uncertainties, in this paper we adopt an improved higher order sliding mode-based controller for the trajectory tracking of a MASS. The proposed algorithm is consisted of two control parts: 1) Adaptive Super-Twisting (AST) part and 2) Time Delay Estimation (TDE) part. Indeed, The TDE part is adopted as concept to take advantage of its model-free nature. This part provides an estimation of perturbations by observing the inputs and the states of the MASS one step into the past without an exact knowledge of the dynamics and the upper bound of uncertainties. Then, at the second stage the AST part will be used to compensate and illuminate TDE error and chattering, respectively as well as to ensure the convergence in a fast finite time. Meanwhile, the adopted adaptive law in order to generate adaptive gains is brought about reduction in the control efforts. Motivated to have all these aforementioned advantages, an Adaptive Super-Twisting Time Delay Estimation (AST-TDE) algorithm in order to control a maritime autonomous surface ship is proposed. For outlining of this research in the rest of the paper, a mathematical model of MASS with considering all induced conditions such as variation in parameters and external disturbances is described in section 2. In section 3, standard form of a super-twisting sliding mode control algorithm is presented. The proposed TDE-based adaptive super-twisting algorithm is presented in section 4. concerning stability analysis of the proposed controller, a Lyapunov approach is conducted in section 5. The

computer simulation results are shown in Section 6 and finally, the conclusion is presented in Section 7.

2. MASS Model

The nonlinear dynamics of MASS can be described in form of 3 D.O.F as follows:

$$\mathbf{M}\dot{\vartheta} + \mathbf{C}(\vartheta)\vartheta + \mathbf{D}(\vartheta)\vartheta = \mathbf{U}_c + \mathbf{M}\mathbf{J}^T(\boldsymbol{\psi})\boldsymbol{\Gamma} \quad (1)$$

$$\dot{\eta} = \mathbf{J}(\boldsymbol{\psi})\vartheta$$

where velocity and position vectors are defined as $\vartheta(t) = [u(t), v(t), r(t)]^T$ and $\eta(t) = [x(t), y(t), \psi(t)]^T$, respectively. The frames regarding surge, sway and yaw motions are shown in Fig. 1. In the aforementioned equation, the rotation matrix $\mathbf{J}(\boldsymbol{\psi}) = \begin{bmatrix} \cos(\psi) & -\sin(\psi) & 0 \\ \sin(\psi) & \cos(\psi) & 0 \\ 0 & 0 & 1 \end{bmatrix}$ is used to transfer coordinates from the Body-Fixed Frame (BFF) to the Earth-Fixed Frame (EFF).

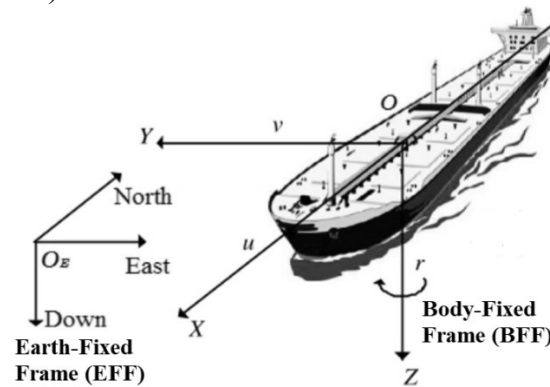

Fig. 1. The earth-fixed frame and body-fixed frame (Fossen, 2016)

For presenting the Eq. 1 in a standard form based on position vector, we can rewrite it using the property of the rotation matrix $\dot{\eta} = \mathbf{J}(\boldsymbol{\psi})\vartheta$ as:

$$\mathbf{M}(\eta)\dot{\eta} + \mathbf{C}(\eta, \dot{\eta})\dot{\eta} + \mathbf{D}(\eta, \dot{\eta})\dot{\eta} = \mathbf{U}_c + \mathbf{U}_d \quad (2)$$

where $\mathbf{U}_c = [F_x, F_y, \tau_\psi]^T$ and $\mathbf{U}_d = \mathbf{M}\mathbf{J}^T(\boldsymbol{\psi})\boldsymbol{\Gamma}$ are control inputs and external disturbances, respectively. These time-varying external disturbances are induced by the winds, waves and ocean currents which they are shown by the vector $\boldsymbol{\Gamma} = [\boldsymbol{\Gamma}_u, \boldsymbol{\Gamma}_v, \boldsymbol{\Gamma}_r]^T$. $\mathbf{M} = \begin{bmatrix} m_{11} & m_{12} & m_{13} \\ m_{21} & m_{22} & m_{23} \\ m_{31} & m_{32} & m_{33} \end{bmatrix} \in \mathbb{R}^3$, $\mathbf{M}(\eta) \in \mathbb{R}^3$, $\mathbf{C}(\eta, \dot{\eta}) \in \mathbb{R}^3$, $\mathbf{D}(\eta, \dot{\eta}) \in \mathbb{R}^3$ are constant inertia matrix, time-varying inertia matrix, time-varying Coriolis matrix and time-varying hydrodynamic damping matrix including both linear and nonlinear parts, respectively. Indeed, with taking into account the nonlinear damping parts, the matrix $\mathbf{D}(\eta)$ is changed to the form $\mathbf{D}(\eta, \dot{\eta})$ and nonlinear coefficients (d_{ij}) are dependent on velocity vector $\dot{\eta} = \mathbf{J}(\boldsymbol{\psi})\vartheta$ (Fang, 2004).

$$\begin{aligned}
M(\eta) &= \begin{bmatrix} m_{11}\cos^2(\psi) + m_{22}\sin^2(\psi) & (m_{11} - m_{22})\sin(\psi)\cos(\psi) & -m_{23}\sin(\psi) \\ (m_{11} - m_{22})\sin(\psi)\cos(\psi) & m_{11}\sin^2(\psi) + m_{22}\cos^2(\psi) & m_{23}\cos(\psi) \\ -m_{23}\sin(\psi) & m_{23}\cos(\psi) & m_{33} \end{bmatrix} \\
C(\eta, \dot{\eta}) &= \begin{bmatrix} \dot{\psi}(m_{22} - m_{11})\sin(\psi)\cos(\psi) & -\dot{\psi}(m_{11}\cos^2(\psi) + m_{22}\sin^2(\psi)) & 0 \\ -\dot{\psi}(m_{11}\sin^2(\psi) + m_{22}\cos^2(\psi)) & \dot{\psi}(m_{11} - m_{22})\sin(\psi)\cos(\psi) & 0 \\ -\dot{\psi}m_{23}\cos(\psi) & -\dot{\psi}m_{23}\sin(\psi) & 0 \end{bmatrix} \quad (3) \\
D(\eta, \dot{\eta}) &= \begin{bmatrix} d_{11}\cos^2(\psi) + d_{22}\sin^2(\psi) & (d_{11} - d_{22})\sin(\psi)\cos(\psi) & -d_{23}\sin(\psi) \\ (d_{11} - d_{22})\sin(\psi)\cos(\psi) & d_{11}\sin^2(\psi) + d_{22}\cos^2(\psi) & d_{23}\cos(\psi) \\ -d_{32}\sin(\psi) & d_{32}\cos(\psi) & d_{33} \end{bmatrix}
\end{aligned}$$

3. Super-Twisting SMC

At first, we introduce a constant diagonal inertia matrix $\bar{M} = \begin{bmatrix} a & 0 & 0 \\ 0 & b & 0 \\ 0 & 0 & c \end{bmatrix} \in \mathbb{R}^3$ as a part of the proposed approach based on Time delay Estimation (TDE) method which is illustrated in the next section. The new form of Eq. 2 is presented as:

$$\bar{M}\ddot{\eta} + N(\eta, \dot{\eta}) + P(\eta, \dot{\eta}, \ddot{\eta}) = U_c \quad (4)$$

where nominal term $N(\eta, \dot{\eta})$ and perturbation term $P(\eta, \dot{\eta}, \ddot{\eta})$ including uncertainties C_p , D_p and external time-varying disturbances U_d are expressed as follows:

$$N(\eta, \dot{\eta}) = C_n(\eta, \dot{\eta})\dot{\eta} + D_n(\eta, \dot{\eta})\dot{\eta} \quad (5)$$

$$P(\eta, \dot{\eta}, \ddot{\eta}) = [M(\eta) - \bar{M}]\ddot{\eta} + C_p(\eta, \dot{\eta})\dot{\eta} + D_p(\eta, \dot{\eta})\dot{\eta} - U_d$$

Let us consider $N = N(\eta, \dot{\eta})$ and $P = P(\eta, \dot{\eta}, \ddot{\eta})$. The sliding surface is as:

$$\begin{aligned}
s &= \dot{e} + \lambda e, \\
e &= \eta - \eta_d
\end{aligned} \quad (6)$$

where η_d is desired trajectories and $\lambda \in \mathbb{R}^3$ is a constant diagonal matrix as gains. The derivation of sliding surface can be resulted as follows:

$$\dot{s} = \ddot{e} + \lambda\dot{e} = \ddot{\eta} - \ddot{\eta}_d + \lambda\dot{e} = \bar{M}^{-1}[U_c - N - P] - \ddot{\eta}_d + \lambda\dot{e} \quad (7)$$

The standard form for a super-twisting algorithm can be expressed as (Id et al., 2018):

$$\begin{cases} \dot{s} = -k_1\xi(s)\text{sign}(s) + z \\ \dot{z} = -k_2\text{sign}(s) \end{cases} \quad (8)$$

where $\xi(s) = \text{diag}(|s_1|^{\frac{1}{2}}, |s_2|^{\frac{1}{2}}, |s_3|^{\frac{1}{2}})$ and k_1, k_2 are diagonal positive matrices.

$$\text{sign}(s) = \begin{cases} 1 & , \quad s > 0 \\ 0 & , \quad s = 0 \\ -1 & , \quad s < 0 \end{cases} \quad (9)$$

Using of the Eq. 7 and Eq. 8, the super-twisting control law is appeared as follows:

$$U_c = \bar{M} \left[\ddot{\eta}_d - \lambda \dot{e} - k_1 \xi(s) \text{sign}(s) - k_2 \int_0^t \text{sign}(s) dt \right] + N + P \quad (10)$$

4. Proposed Control Algorithm

In this section, the main strategy in order to promote robustness property and acquire a high performance with an optimal control effort is presented. Fig. 2 illustrates the proposed controller block diagram. This TDE-based super-twisting algorithm can estimate all of the perturbations stemmed from the ocean circumstances and dynamical uncertainties upon the MASS and finally this combined approach can achieve a high accuracy for trajectory tracking of the presented maritime autonomous platform. Also, we can define adaptive gains for the super-twisting control law Eq. 10 with considering the following theorem as follows:

Theorem: regard control input in Eq. 10. Assume that the perturbation P is bounded as:

$|P| \leq \sigma |s|^{\frac{1}{2}}$ where, $\sigma > 0$ is unknown. Then, for any initial conditions $\eta(0), s(0)$ the sliding surface $s = 0$ will be reached in finite time through super-twisting control law Eq. 10 with the following adaptive gains (Shtessel et al., 2010):

$$\begin{cases} \frac{dk_1}{dt} = \emptyset \sqrt{\frac{\theta}{2}} & \text{if } s \neq 0 \\ \frac{dk_1}{dt} = 0 & \text{if } s = 0 \\ dk_2 = 2\varepsilon \frac{dk_1}{dt} \end{cases} \quad (11)$$

where, \emptyset, θ and ε are positive constants.

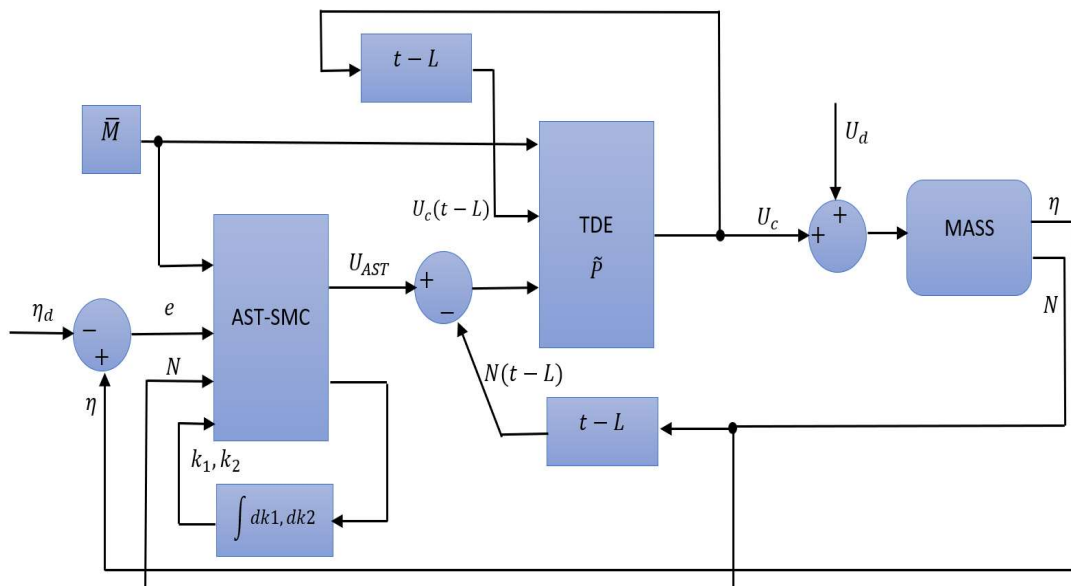

Fig. 2. Proposed AST-TDE Controller

Let us regard applied perturbations as:

$$\tilde{P} \cong P_{t-L} = U_c(t-L) - N(t-L) - \bar{M}\ddot{\eta}(t-L) \quad (12)$$

where L is a delay time for the TDE part and it is assigned with a very small value. Also, the second derivative for the delayed positions is calculated using the following function (Nejatbakhsh et al., 2015):

$$\ddot{\eta}(t-L) = \frac{\eta(t) - 2\eta(t-L) + \eta(t-2L)}{L^2} \quad (13)$$

Substituting P by its estimate \tilde{P} in the Eq. 10:

$$U_c = \bar{M} \left[\ddot{\eta}_d - \lambda \dot{e} - k_1 \xi(s) \text{sign}(s) - k_2 \int_0^t \text{sign}(s) dt \right] + N + \tilde{P} \quad (14)$$

Using Eq. 11 and Eq. 13, the proposed Adaptive Super-Twisting Time Delay Estimation (AST-TDE) control law is resulted as follows:

$$U_c = U_c(t-L) + \bar{M} \left[\ddot{\eta}_d - \ddot{\eta}(t-L) - \lambda \dot{e} - k_1 \xi(s) \text{sign}(s) - k_2 \int_0^t \text{sign}(s) dt \right] + N - N(t-L) \quad (15)$$

5. Lyapunov Stability Analysis

Let us define TDE error as:

$$\delta = \bar{M}^{-1}[\tilde{P} - P] \quad (16)$$

Now we can rewrite Eq. 8 as follows:

$$\begin{cases} \dot{s} = -k_1 \xi(s) \text{sign}(s) + z \\ \dot{z} = -k_2 \text{sign}(s) + \delta \end{cases} \quad (17)$$

Eq. 16 should be presented in a form proper for the Lyapunov stability analysis. Therefore, the new states are introduced as follows:

$$w = [w_1, w_2]^T = [|s|^{\frac{1}{2}} \text{sign}(s), z]^T \quad (18)$$

The Eq. 16 is rewritten as follows:

$$\begin{cases} \dot{w}_1 = \frac{1}{|w_1|} \left(\frac{-k_1}{2} w_1 + \frac{1}{2} w_2 \right) \\ \dot{w}_2 = \frac{-k_2}{|w_1|} w_1 + \frac{1}{2} \delta \end{cases} \quad (19)$$

In a state-space form of the above equation, Eq. 18 is expressed as:

$$\dot{w} = \frac{1}{|w_1|} (Aw + B\dot{\delta}|w_1|) \quad (20)$$

where,

$$A = \begin{bmatrix} \frac{-k_1}{2} & \frac{1}{2} \\ -k_2 & 0 \end{bmatrix}, B = \begin{bmatrix} 0 \\ \frac{1}{2} \end{bmatrix}$$

We choose Lyapunov function candidate as:

$$v(w) = (\beta + 4\varepsilon^2)w_1^2 + w_2^2 - 4\varepsilon w_1 w_2 \quad (21)$$

In a matrix form, $v(w)$ is written as follows:

$$v(w) = w^T R w = w^T \begin{bmatrix} \beta + 4\varepsilon^2 & -2\varepsilon \\ -2\varepsilon & 1 \end{bmatrix} w, \beta > 0, \varepsilon > 0 \quad (22)$$

where,

R is positive definite if $\beta > 0$ and ε is any real number while the following boundary law is fulfilled.

$$\lambda_{\min}\{R\}\|w\|_2^2 \leq v(w) \leq \lambda_{\max}\{R\}\|w\|_2^2 \quad (23)$$

where, λ_{\min} , λ_{\max} are minimum and maximum eigenvalues of the matrix R and $\|w\|_2^2$ is an Euclidean norm of the states w .

Derivative of Lyapunov function in Eq. 21 is presented as follows:

$$\dot{v} = \dot{w}^T R w + w^T R \dot{w} = \frac{1}{|w_1|} w^T (A^T R + R A) w + \frac{\dot{\delta}}{|w_1|} |w_1| B^T R w \quad (24)$$

where, $\dot{\delta}$ is bounded $|\dot{\delta}| \leq \gamma$ (Kali et al., 2018).

$$\dot{\delta}|w_1| B^T R w \leq \dot{\delta}^2 |w_1|^2 + w^T R B B^T R w \leq \gamma^2 w^T C^T C w + w^T R B B^T R w \quad (25)$$

where, $C = [1 \ 0]$.

Using the arguments shown in Eq. 23 and Eq. 24, we can show that:

$$\dot{v} \leq -\frac{1}{|w_1|} w^T (A^T R + R A + \gamma^2 C^T C + R B B^T) w \leq -\frac{1}{|w_1|} w^T Q w \quad (26)$$

where, Q is a symmetrical positive definite matrix as follows:

$$Q = -(A^T R + R A + \gamma^2 C^T C + R B B^T) = \begin{bmatrix} (1 - k_1(\beta + 4\varepsilon^2) + 4k_2\varepsilon + \gamma^2 + \varepsilon^2) & * \\ \frac{1}{2}(\beta + 4\varepsilon^2) + k_1\varepsilon - \frac{1}{2}\varepsilon - k_2 & -2\varepsilon + \frac{1}{4} \end{bmatrix} \quad (27)$$

\dot{v} is negative definite, then:

$$\dot{v} \leq -\frac{1}{|w_1|} \lambda_{\min}\{Q\} \|w\|_2^2 \quad (28)$$

6. Simulation Results

The main purpose of this section is a comparative study upon the computer simulation results of the proposed Adaptive Super-Twisting Time Delay Estimation (AST-TDE) controller, Super-Twisting Time Delay Estimation (ST-TDE) and a conventional super-twisting (CST) controller. In order to investigate resilient factor of the three controllers against unexpected perturbations, all of the time-varying external disturbances induced by the winds, waves and ocean currents are envisaged. These disturbances are considered for applying upon the MASS with 3 D.O.F in which their respective vectors $\mathbf{F} = [\mathbf{F}_u, \mathbf{F}_v, \mathbf{F}_r]^T$ can be modeled as follows [8]:

$$\begin{cases} \mathbf{F}_u = 0.1v^3 + 0.06u + 0.01\sin(t) \\ \mathbf{F}_v = uv + 0.1u + 0.01\sin(t) \\ \mathbf{F}_r = 0.4ur + v^2 + 0.01\sin(t) \end{cases} \quad (29)$$

In the mathematical modeling of MASS, the nonlinear parts of the damping coefficients are another significant terms regarded in these simulations which they are described as follows [8]:

$$\begin{aligned} d_{11} &= 0.72 + 1.33|u| + 5.87u^2 \\ d_{22} &= 0.8896 + 36.5|v| + 0.805|r| \\ d_{23} &= 7.25 + 0.8451|v| + 3.45|r| \\ d_{32} &= 0.0313 + 3.96|v| + 0.13|r| \\ d_{33} &= 1.9 - 0.08|v| + 0.75|r| \end{aligned} \quad (30)$$

Other damping coefficients in the damping matrix 3×3 are assigned to zero. Also, the constants in inertia matrix are assigned as follows:

$$\mathbf{M} = \begin{bmatrix} m_{11} & m_{12} & m_{13} \\ m_{21} & m_{22} & m_{23} \\ m_{31} & m_{32} & m_{33} \end{bmatrix} = \begin{bmatrix} 25.8 & 0 & 0 \\ 0 & 33.8 & 1.0115 \\ 0 & -0.4087 & 2.76 \end{bmatrix}$$

Regarding trajectory tracking goals, the circle path and a ramp mathematical function as desired yaw angle are adopted to be tracked by MASS in the surge-sway 2D plane and yaw angle, respectively. The equations of these desired paths with the initial conditions $[0 \ 0 \ 0]$ and simulation time $t = 100 \text{ sec}$. are as follows:

$$\eta_d = \begin{cases} x_d = 20\sin(0.02\pi t) \\ y_d = 20\cos(0.02\pi t) \\ \psi_d = 0.01\pi t \end{cases} \quad (31)$$

The output results of this computer simulation are shown in Fig. 3, Fig. 4 and Fig. 5 as output results for the CST, ST-TDE and AST-TDE, respectively. An objectionable transient response with high magnitude of over-shoot is clearly observed in the tracking errors depicted in Fig. 3 (a) in comparison with the smooth and accurate responses with a very small magnitude of over-shoot in Fig. 4 (a) and Fig. 5 (a).

Concerning control inputs, they are shown in the Fig. 3 (b), Fig. 4 (b) and Fig. 5 (b) for the conventional super-twisting controller, proposed TDE-based super-twisting controller and the proposed TDE-based adaptive super-twisting algorithm, respectively. As it is depicted, the amplitudes in commencement time of control input signals are less in the proposed controllers than conventional super-twisting controller. Therefore, the beginning control efforts are decreased in comparison with the conventional super-twisting control approach.

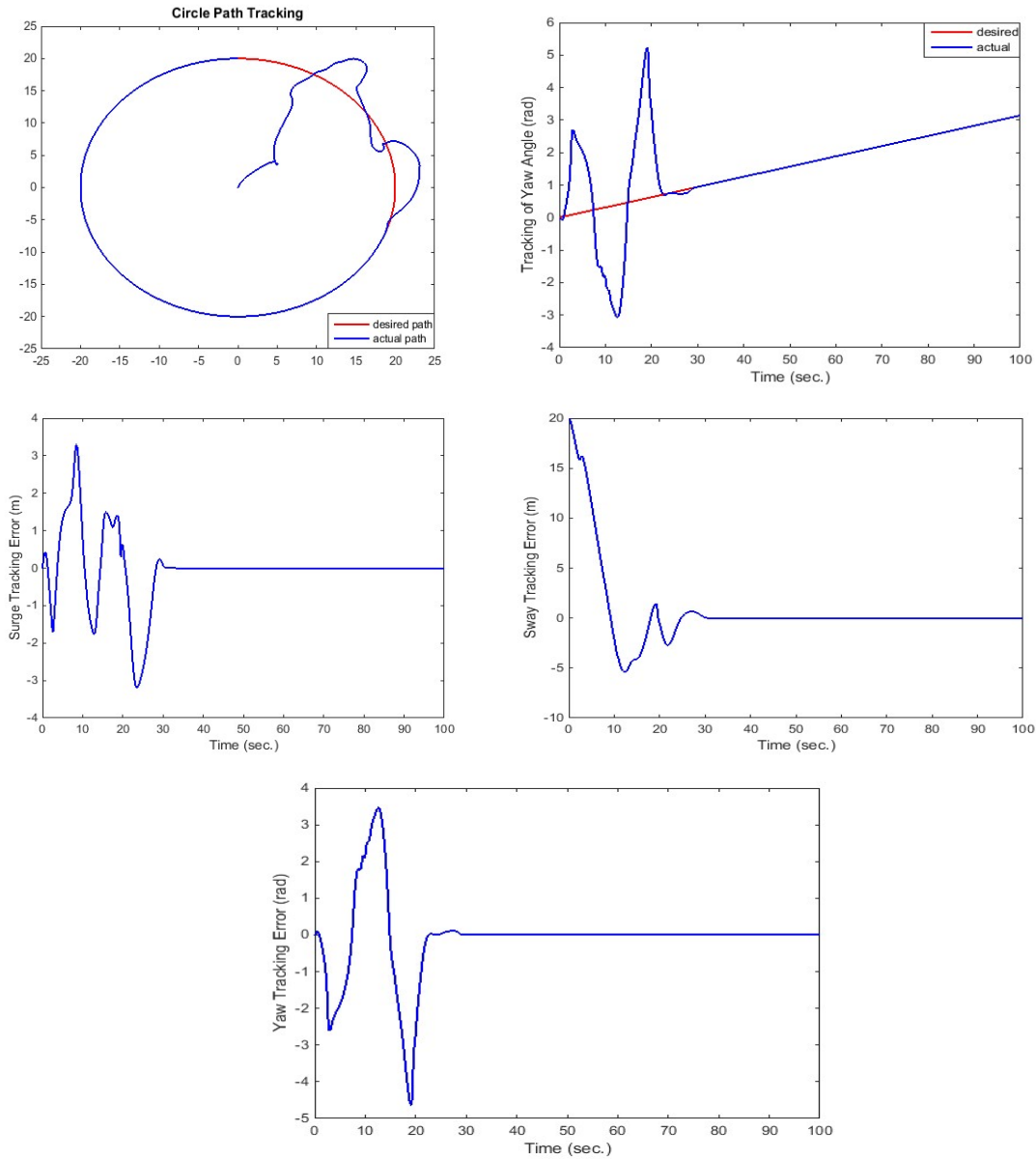

a) Tracking Errors and Trajectory Tracking



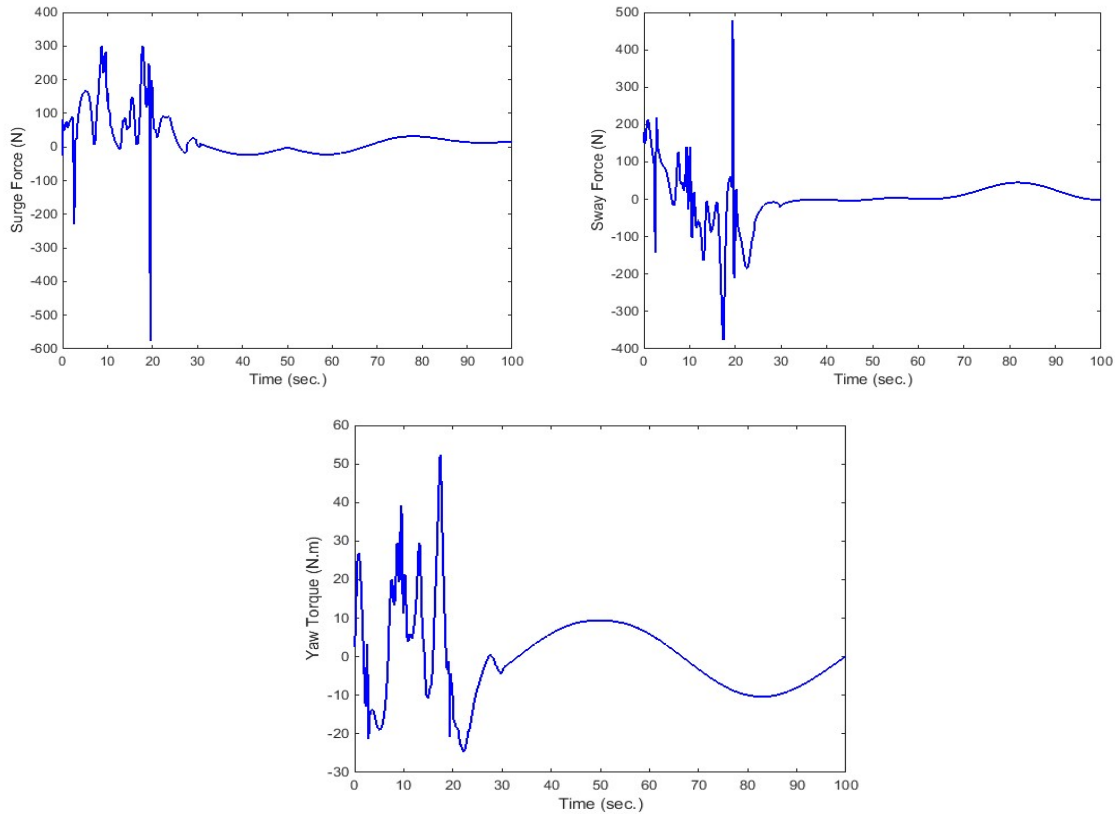

b) Control Inputs

Fig. 3. Controller responses in the CST

Concerning path following conditions, we indeed be comprehended an underdamped response during trajectory tracking of both circle path and yaw angle for three controllers but for the CTS the high damping is led an increasing in control input magnitudes illustrated in Fig. 3 (b) particularly during transient period while the same paths are smoothly tracked by the MASS with the low control efforts presented in Fig. 4 (b) and Fig. 5 (b). Meanwhile, from the point of view of maintenance, the applied mechanical stress on thrusters has been drastically dropped by the proposed controllers of ST-TDE and AST-TDE which this feature can increase life time of used actuators. In comparison with the proposed ST-TDE approach, a better management of control efforts is accomplished by adaptive gains in the proposed algorithm of AST-TDE which these adaptive gains are depicted in Fig. 5 (c). Moreover, a trade-off between controller efforts and tracking errors is observed and high accuracy and fast response are demonstrated as advantages for the proposed controller of AST-TDE.

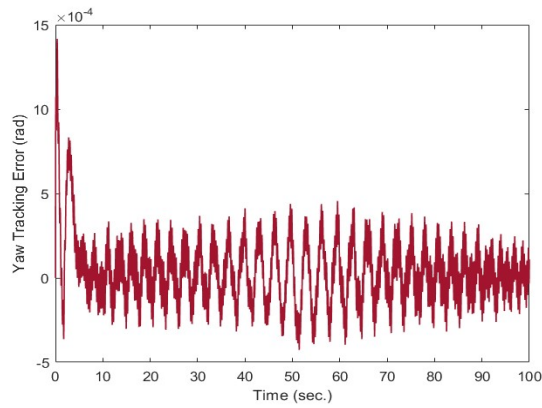
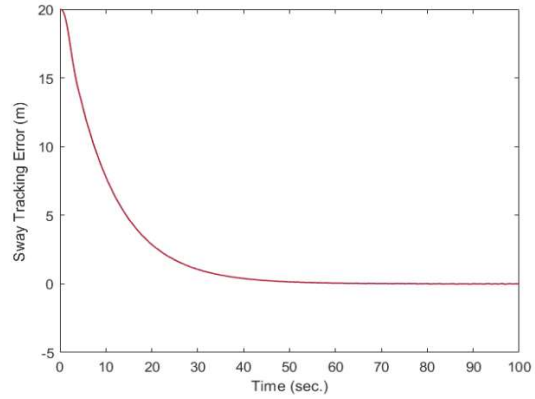
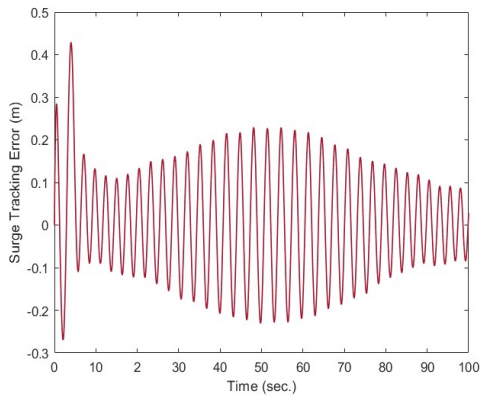
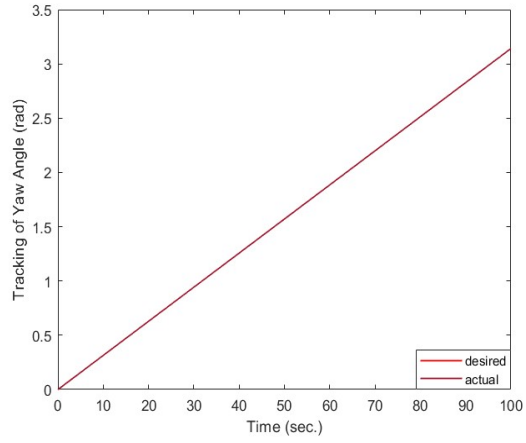
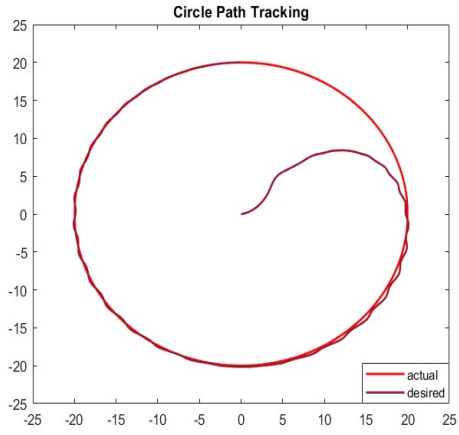

a) Tracking Errors and Trajectory Tracking

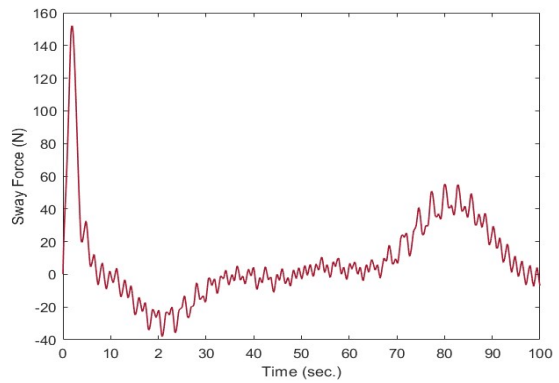
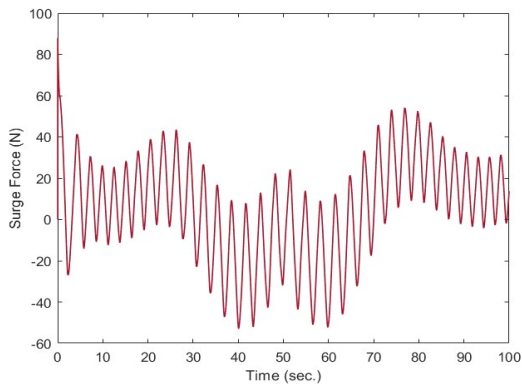

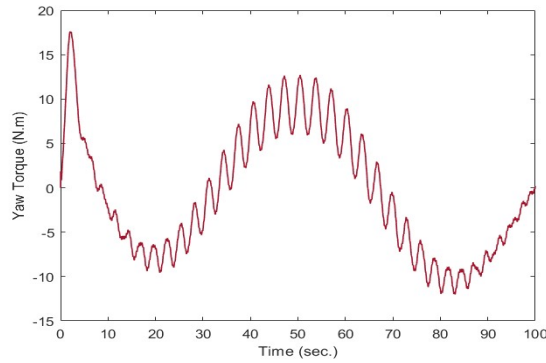

b) Control Inputs

Fig. 4. Controller responses in the ST-TDE

In terms of the robustness feature, the proposed ST-TDE and AST-TDE controllers aptly estimate high complex disturbances and compensate influences of them. As our proposed controller is consisted of two parts, we have two tasks are executed by AST-TDE algorithm. These tasks are estimation and compensation which are fulfilled by the TDE part and AST-SMC part, respectively. Although the induced perturbations including time-varying disturbances and uncertainties have been estimating in Fig. 5 (d) by the TDE part, but this estimation will be inaccurate and bring in large estimation errors when the MASS has fast time-varying dynamics. Therefore, we have adopted AST-SMC part in order to incessantly compensate TDE errors and increase convergence speed. This compensation procedure is illustrated in Fig. 5 (e). Furthermore, the nonlinear parts of damping coefficients are regarded in the drag force modeling which this consideration can ascend probability of occurring unexpected behaviours due to nonlinear dynamic uncertainties. Therefore, all the estimated perturbations are compensated by control inputs shown in Fig. 5 (d). As it is shown in Fig. 5, the proposed algorithm is acted as a robust controller and despite of the mentioned perturbations, we have an accurate and fast response.

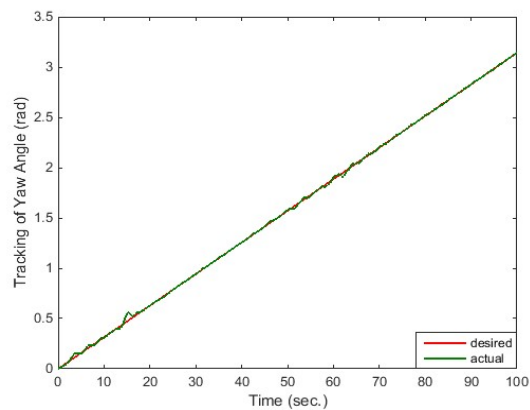
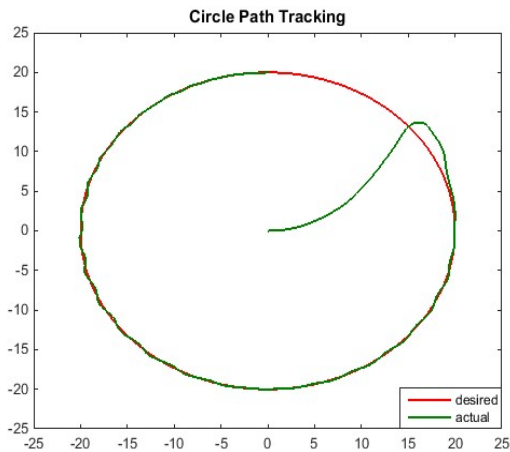

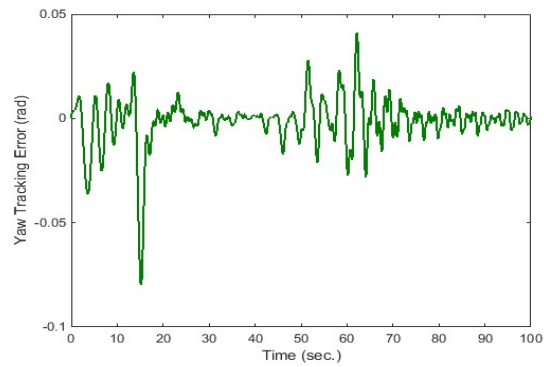
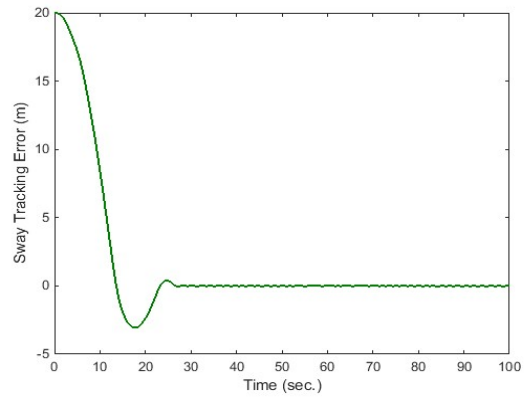
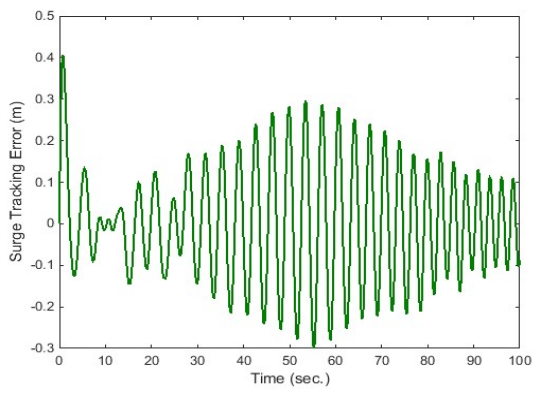

a) Tracking Errors and Trajectory Tracking

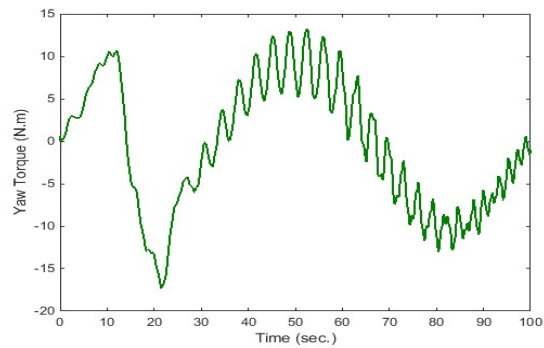
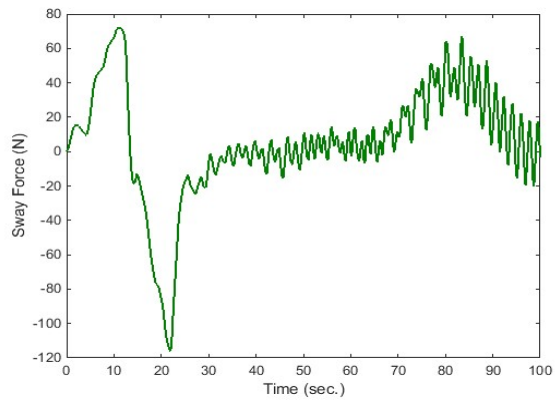
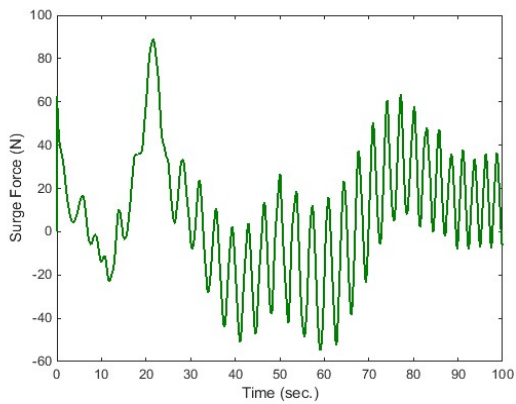

b) Control Inputs



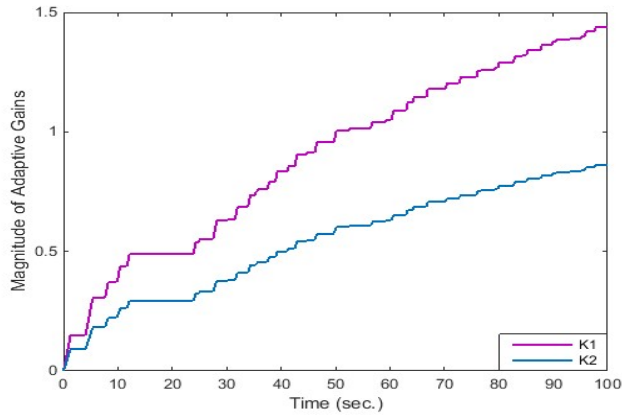

c) Adaptive Gains of Super-Twisting Part

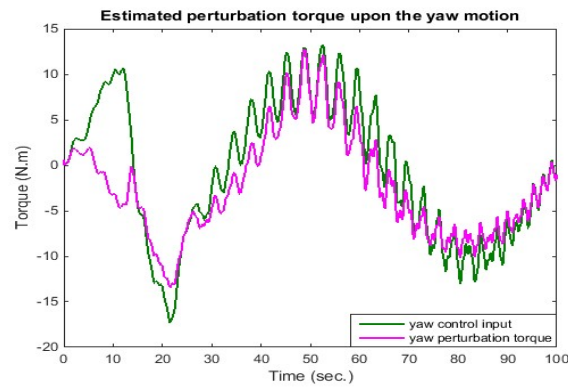
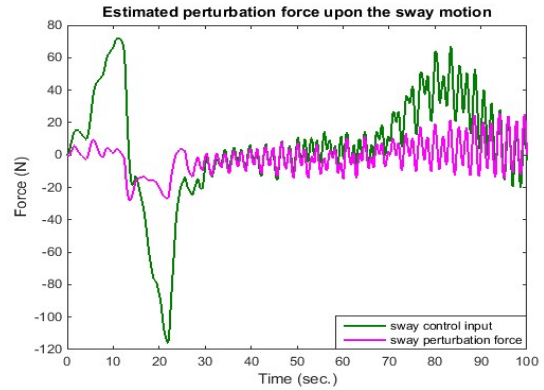
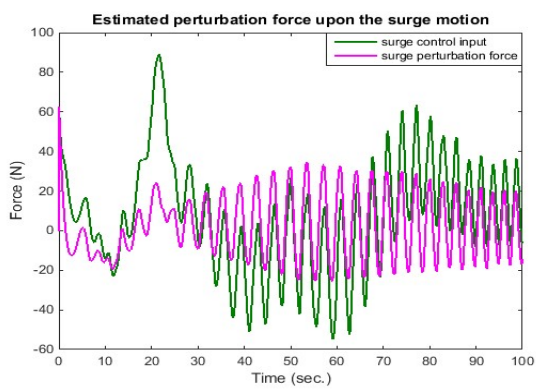

d) Estimated Perturbations by the TDE Part

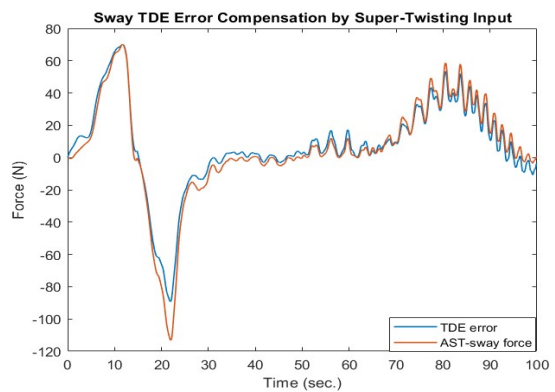
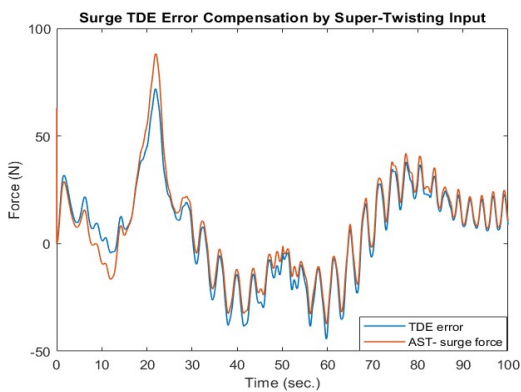

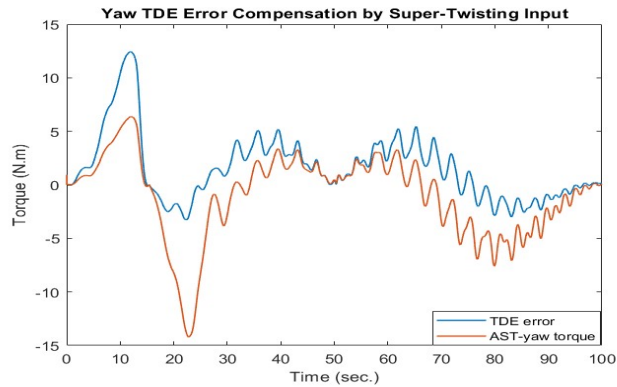

e) TDE-Error Compensation by AST-SMC Part
Fig. 5. Controller responses in the proposed AST-TDE

In the Fig. 5 (d), the perturbations forces and torque estimated by the TDE part of proposed controller are shown. It is clear compensating the perturbations by AST-SMC control inputs on this comparative analysis.

Regarding adaptive gains in the proposed control law Eq. 15, adding the adaptive feature to the proposed ST-TDE is brought about a drastically descending of control efforts for the proposed AST-TDE. Indeed, although the proposed ST-TDE has a high accuracy toward the CST but concerning the AST-TDE, the trajectory tracking can be done with lower control efforts with a roughly same accuracy toward the ST-TDE. The acquired results in Fig. 5 (b) denote to this fact.

The adjustable parameters for three controllers are assigned by the values given in Table. 1.

Table. 1. Adjustable Parameters of Controllers

Controller Parameter	CST	ST-TDE	AST-TDE
k_1	diag(1,1,1)	diag(1,1,1)	-
k_2	diag(1,0.5,1)	diag(1,0.5,1)	-
λ	diag(2,2,2)	diag(0.3,0.1,0.3)	diag(1,1,1)
\bar{M}	-	diag(0.07,0.1,0.06)	diag(0.05,0.09,0.02)
ϕ	-	-	diag(0.3,0.3,0.3)
θ	-	-	diag(0.3,0.3,0.3)
ε	-	-	diag(0.3,0.3,0.3)
L	-	0.001	0.001

The results of a comparative analysis concerning control efforts are given in Table. 2 and their magnitudes are calculated using the following equation:

$$\frac{1}{n} \sum_{i=1}^n |u_i| + |e_i| \quad (32)$$

Table. 2. Magnitude of Control Efforts

Controller Effort	CST	ST-TDE	AST-TDE
Surge Effort	125.8380	21.9514	14.2389
Sway Effort	100.3250	53.0196	46.7752
Yaw Effort	17.5614	6.0212	4.9560



7. Conclusion

Motivated to solve the problems of control system for the maritime autonomous platforms particularly autonomous ship, in this paper an improved super-twisting sliding mode control based on time delay estimation method and adaptive gains is proposed. We indeed adopt a robust adaptive strategy for tackling with the complex and unexpected conditions in an ocean environment which they are induced by the time-varying disturbances including winds, waves and ocean currents. Moreover, an autonomous ship motion is incessantly affected by changing in its inertia and drag force matrices which cause intensifying the nonlinear uncertainties in MASS dynamics. Some simulation studies are done to compare the proposed controller with conventional super-twisting algorithm. The new controller assures fast convergence, accurate trajectory tracking and optimal control efforts which facilitates an effective control. In addition, its robustness is tested in presence of mentioned perturbations. The simulation results depicted that this procedure has significant properties in trajectory tracking with acceptable precision.

References

Abdelaal, M., Fr, M., Hahn, A., 2018. Nonlinear Model Predictive Control for trajectory tracking and collision avoidance of underactuated vessels with disturbances ☆ 160, 168–180. <https://doi.org/10.1016/j.oceaneng.2018.04.026>

Esfahani, H.N., Azimirad, V., Eslami, A., Asadi, S., 2013. An optimal sliding mode control based on immune-wavelet algorithm for underwater robotic manipulator. 2013 21st Iran. Conf. Electr. Eng. ICEE 2013 1–6. <https://doi.org/10.1109/IranianCEE.2013.6599587>

Esfahani, H.N., Azimirad, V., Zakeri, M., 2014. SLIDING MODE-PID FUZZY CONTROLLER WITH A NEW REACHING MODE FOR UNDERWATER ROBOTIC MANIPULATORS 258, 2014.

Esfahani, H. N. 2019. Robust Model Predictive Control for Autonomous Underwater Vehicle–Manipulator System with Fuzzy Compensator. Polish Maritime Research (forthcoming), 10.2478/pomr-2019-00139.

Fang, Y., 2004. Global output feedback control of dynamically positioned surface vessels : an adaptive control approach q 14, 341–356. [https://doi.org/10.1016/S0957-4158\(03\)00064-3](https://doi.org/10.1016/S0957-4158(03)00064-3)

Fossen, T.I., 2016. Handbook of Marine Craft Hydrodynamics and Motion Control [Bookshelf]. IEEE Control Syst. 36, 78–79. <https://doi.org/10.1109/mcs.2015.2495095>

Fu, M., Yu, L., 2018. Finite-time extended state observer-based distributed formation control for marine surface vehicles with input saturation and disturbances. Ocean Eng. 159, 219–227. <https://doi.org/10.1016/j.oceaneng.2018.04.016>

Huang, H., Gong, M., Zhuang, Y., Sharma, S., Xu, D., 2019. A new guidance law for trajectory tracking of an underactuated unmanned surface vehicle with parameter perturbations. Ocean Eng. 175, 217–222. <https://doi.org/10.1016/j.oceaneng.2019.02.042>

Hung, N.T., Rego, F., Crasta, N., Pascoal, A.M., 2018. Input-Constrained Path Following for Autonomous Marine Vehicles with a Global Region of Attraction*. IFAC-PapersOnLine 51, 348–353. <https://doi.org/10.1016/j.ifacol.2018.09.499>

Id, D., Rehman, F., Khan, Q., 2018. Smooth super-twisting sliding mode control for the class of underactuated systems 1–21.

Jamalzade, M.S., Koofigar, H.R., Ataei, M., 2016. Adaptive fuzzy control for a class of constrained nonlinear systems with application to a surface vessel. J. Theor. Appl. Mech. 54, 987. <https://doi.org/10.15632/jtam-pl.54.3.987>

Kali, Y., Saad, M., Benjelloun, K., 2018. Optimal super-twisting algorithm with time delay estimation for robot manipulators based on feedback linearization. Rob. Auton. Syst. 108, 87–99. <https://doi.org/10.1016/j.robot.2018.07.004>

Liu, C., Zheng, H., Negenborn, R.R., Chu, X., 2013. Computational Logistics 8197, 166–180. <https://doi.org/10.1007/978-3-642-41019-2>

Liu, C., Zou, Z., Yin, J., 2015. Trajectory tracking of underactuated surface vessels based on neural network and hierarchical sliding mode. J. Mar. Sci. Technol. 20, 322–330. <https://doi.org/10.1007/s00773-014-0285-y>

Liu, J., Luo, J., Cui, J., Peng, Y., 2016. Trajectory Tracking Control of Underactuated USV with Model Perturbation and External Interference. MATEC Web Conf. 77, 0–5. <https://doi.org/10.1051/mateconf/20167709009>

Liu, L., Wang, D., Peng, Z., 2019. State recovery and disturbance estimation of unmanned surface vehicles based on nonlinear extended state observers. *Ocean Eng.* 171, 625–632. <https://doi.org/10.1016/j.oceaneng.2018.11.008>

Liu, L., Wang, D., Peng, Z., Wang, H., 2016. Predictor-based LOS guidance law for path following of underactuated marine surface vehicles with sideslip compensation. *Ocean Eng.* 124, 340–348. <https://doi.org/10.1016/j.oceaneng.2016.07.057>

Lu, Y., Zhang, G., Sun, Z., Zhang, W., 2018. Robust adaptive formation control of underactuated autonomous surface vessels based on MLP and DOB. *Nonlinear Dyn.* 94, 503–519. <https://doi.org/10.1007/s11071-018-4374-z>

Nejatbakhsh, H., Azimirad, V., Danesh, M., 2015. A Time Delay Controller included terminal sliding mode and fuzzy gain tuning for Underwater Vehicle-Manipulator Systems. *Ocean Eng.* 107, 97–107. <https://doi.org/10.1016/j.oceaneng.2015.07.043>

Sharma, S.K., Sutton, R., Motwani, A., Annamalai, A., 2014. Non-linear control algorithms for an unmanned surface vehicle. *Proc. Inst. Mech. Eng. Part M J. Eng. Marit. Environ.* 228, 146–155. <https://doi.org/10.1177/1475090213503630>

Shojaei, K., 2016. Observer-based neural adaptive formation control of autonomous surface vessels with limited torque. *Rob. Auton. Syst.* 78, 83–96. <https://doi.org/10.1016/j.robot.2016.01.005>

Shtessel, Y.B., Moreno, J.A., Plestan, F., Fridman, L.M., Poznyak, A.S., 2010. Super-twisting Adaptive Sliding Mode Control : a Lyapunov Design. pp. 5109–5113.

Sun, Z., Zhang, G., Yi, B., Zhang, W., 2017. Practical proportional integral sliding mode control for underactuated surface ships in the fields of marine practice. *Ocean Eng.* 142, 217–223. <https://doi.org/10.1016/j.oceaneng.2017.07.010>

Tanakitkorn, K., Phillips, A.B., Wilson, P.A., Turnock, S.R., 2017. Sliding mode heading control of an overactuated , hover-capable autonomous underwater vehicle with experimental verification 396–415. <https://doi.org/10.1002/rob.21766>

Valenciaga, F., 2014. A SECOND ORDER SLIDING MODE PATH FOLLOWING CONTROL FOR AUTONOMOUS SURFACE VESSELS 16, 1515–1521. <https://doi.org/10.1002/asjc.840>

Wang, W., Mateos, L.A., Park, S., Leoni, P., Gheneti, B., Duarte, F., Ratti, C., Rus, D., 2018. Design , Modeling , and Nonlinear Model Predictive Tracking Control of a Novel Autonomous Surface Vehicle. *IEEE Int. Conf. Robot. Autom.* 6189–6196. <https://doi.org/10.1109/ICRA.2018.8460632>

Yi, B., Qiao, L., Zhang, W., 2016. Two-time scale path following of underactuated marine surface vessels : Design and stability analysis using singular perturbation methods. *Ocean Eng.* 124, 287–297. <https://doi.org/10.1016/j.oceaneng.2016.07.006>

Zhang, P., 2018. Dynamic Surface Adaptive Robust Control of Unmanned Marine. *J. Robot.* 2018.

Zheng, H., Negenborn, R.R., Lodewijks, G., 2014. Trajectory tracking of autonomous vessels using model predictive control. *IFAC Proc.* Vol. 19, 8812–8818. <https://doi.org/10.3182/20140824-6-ZA-1003.00767>