

O. M. Sinchuk¹,
orcid.org/0000-0002-9078-7315,
T. M. Beridze¹,
orcid.org/0000-0003-2509-3242,
O. Yu. Mykhailenko^{*1},
orcid.org/0000-0003-2898-6652,
V. V. Horshkov¹,
orcid.org/0000-0002-5129-4083,
M. V. Rogoza²,
orcid.org/0000-0002-2395-227X,
R. Strzelecki³,
orcid.org/0000-0001-9437-9450

1 – Kryvyi Rih National University, Kryvyi Rih, Ukraine
2 – Dnipro University of Technology, Dnipro, Ukraine
3 – Gdańsk University of Technology, Gdańsk, the Republic of Poland
^{*} Corresponding author e-mail: mykhailenko@knu.edu.ua

IMPROVING THE EFFICIENCY OF STREET LIGHTING ELECTRICAL SYSTEMS

Purpose. To derive mathematical expressions that, using the available information, will allow forecasting the levels of electricity consumption by the city's outdoor lighting network in the main possible scenarios for several years ahead, as well as when developing an energy-efficient smart control system for the electrotechnical complex of lighting complex.

Methodology. Creating an effective intelligent outdoor lighting control system involves the use of the following methods. First, using the empirical measurement method, information on illumination, electricity consumption, car and pedestrian traffic is obtained. Statistical methods are used to identify patterns and relationships between the measured values, as well as to make subsequent forecasts. For intelligent control of outdoor lighting, a decision-making method based on fuzzy inference is used, which allows one, based on information about the operating conditions of the outdoor lighting network, to determine the recommended value of the current or value of lighting devices and the required power source. This approach will ensure maximum system efficiency.

Findings. The obtained analytical dependencies for forecasting the electricity consumption, which are based on data from different time intervals, have determination coefficients of 66.8 and 88.1 %, respectively. The simulation of the operation of a fuzzy control system for the electricity consumption of outdoor lighting on the example of an operated part of the road operated and illuminated by ten 100 W LED lamps for summer and winter nights with different discrete control steps confirms the possibility of achieving the efficiency of outdoor lighting when using the proposed controllability option. The combined-powered control system is more efficient, reducing electricity consumption in summer and winter by more than 70 % compared to traditional control schemes.

Originality. A fuzzy control system for the electrical complex of outdoor lighting in cities is improved, which takes into account the electricity tariff in addition to the level of illumination and the car or pedestrian traffic when generating the control action for the LED driver and determining the rational power source (grid or grid/battery) for lighting devices.

Practical value. The architecture of the system for controlling electricity consumption by electrical receivers of lighting networks based on the fuzzy inference algorithm is developed, which is recommended for use to ensure an increase in the energy efficiency of this class of municipal consumers.

Keywords: *street lighting, power consumption, forecasting, fuzzy control, modeling*

Introduction. In Ukraine, lighting electric networks are structurally integrated into the national energy system and represent an important segment in the formation of levels of electricity consumption and, logically, as active consumers of this type of energy, they should be among the creative actors in solving the problem of increasing energy efficiency in the country in general [1].

However, with a careful analysis of the possible ways of achieving the expected effect in the energy efficiency of outdoor lighting (OL), nevertheless, from a number of generalized problems that need to be solved in the structure of the technology of operation of the analyzed types of electric power systems, the primary – basic task of these complexes (for which they exist) comes to the fore – ensuring the quality of lighting to the maximum possible reach of this indicator [2].

However, this problem is supplemented with new, additional factors over time.

Thus, as of January 1, 2022, the total length of OL power grids in populated areas of Ukraine is more than 100,000 km, the number of light points is about 2 million units, with a trend of further growth [3].

Based on the official data, from literary sources available to the author, it can be determined that the existing (general) state, such as: technical and technological indicators of OL complex-

es of most cities, district centers and villages of Ukraine, from the standpoint of modernity, need to be improved [4].

Among such positions that exist today, and are odious for Ukraine, a special place among the indicators inherent in OL systems is occupied by the problem of the need to improve the electrical energy of these complexes, since external lighting systems in Ukraine are more than twice as energy-intensive and consume almost twice as much electricity as needed lighting than in the developed countries of the world [5, 6].

The necessity of permanence as a process of increasing efficiency, including the energy efficiency and quality of OL of cities and settlements in Ukraine, results in a problem, the solution of which is absolutely necessary both for the economy of local budgets and for the approximation of the state of compliance with the desired modern level of comfort of residents – the respective settlements citizens.

At the same time, an important addition to the above is the fact that the components of the modern perception of the format of the comprehensive efficiency of OL cities, today, have been supplemented by a number of additional and very influential components, the solution of which is no less important, both in time and as a final option, than perfect existing problems.

Such additions include continuity and the need for adaptive control of the level of illumination in the hours of the day and as a function of a number of other non-trivial input parameters, which are provoked by the circumstances of the current situation both in cities specifically and in the country in general.

For real, in the conditions of modern perception, and visible and realistically achievable horizons, expected levels of energy efficiency, it is advisable to “disengage” from the existing – purely canonical vision of the ways to implement this process – exclusively by reducing the amount of electricity consumption, and to the extent necessary to concentrate on solving the controllability problem for this process with an emphasis on the possibility of not only reducing the amount of electricity consumption, although this remains a priority task in any option for solving the problem of increasing energy efficiency, as much as in restraining the growth rates of this indicator.

However, when forming a “road map” of such a potentially effective solution option, one must understand that managing the levels of electricity consumption over time for such complex technologically complex and aggregatively structured systems as lighting networks is a complex multi-criteria process with a number of unpredictable and often contradictory system-forming factors both in number and in terms of their influence on the modes of operation of the analyzed electric power complex [7, 8].

The above “logic of contradictions” can, to a large extent, be minimized in accordance with the algorithm of the electricity consumption process, according to a number of criteria and, including, the function of the variability in time of the levels of light emitted by the lamps. That is, the very process of electricity consumption in lighting networks, in this version, can be characterized as transit – unclear, as a function of the level of illumination.

In this version, the control of OL is significantly changed, with the transition from a single-functionality option to a multifunctional one. At the same time, both the functional capabilities of these complexes – the limits of the use of technical potential, and the efficiency of their functioning as a whole – are expanding.

Literature review. Currently, street lighting is managed using fairly simple algorithms. As a rule, after sunset, with the onset of dusk, lighting devices are turned on at 50 % power, with the onset of night, OL light points begin to work at full power. After that, the outdoor lighting works without changing the mode of operation until 11 p.m., after which it is turned off until dawn. At the same time, this is a generalized regime that may change depending on the city or town, the intensity of traffic and pedestrian traffic, etc. [9].

For example, in the city of Kyiv, 50 % of light points are turned off between 11:00 PM and 6:00 AM [10]. This partial shutdown is explained by the high pace of life in this city. In the Poltava community, the streets along the trolleybus routes are illuminated from 11:00 p.m. to 12:00 a.m., after which the outdoor lighting is turned off until morning [11]. In the city of Kryvyi Rih, for the same period of time, which is indicated above, from 11:00 p.m. to 5:00 a.m., the lighting network is turned off almost completely, and at 5 o'clock in the morning it is turned on again until dawn [12]. This is due to the fact that the city is industrial and the end of the night shift or the start of the day shift in factories starts very early, that is, workers need to get to the workplace or go home. Of course, all the work schedules described above correspond to peacetime, during martial law they are usually not observed for obvious reasons.

Such an approach to outdoor lighting control can be considered manual, which limits and even makes impossible the use of technological potential, which a priori can be achieved in the field of control of the efficiency of the OL complex, because special means, such as remote control and others are used in this case only during switching on/off lighting devices, and energy consumption regulation as such does not occur at all.

In this format, the management of OL networks is carried out, as a rule, centrally and remotely by dispatchers from control points using switchgear-contactors. Telecontrol systems are also used with discreteness when transmitting commands and continuity – in the mode of monitoring the technical condition of OL networks [13].

To summarize, the realities of the manufacturability of the

functions of the existing automated control systems (ACS) for settlements outdoor lighting complexes in Ukraine are mostly limited to “on – off” operations, according to the hours of the day: evening – night. At the same time, there are certain positive practical developments in the field of intelligent control of outdoor lighting networks [14], but they are mostly inherent in foreign studies, where various variants of ACS are actively implemented among the known and practically implemented modern technologies in the field of outdoor lighting [15, 16].

Based on the results of a preventive search and taking into account the existing, significant in scope, variability and uncertainty of the limits and levels of influencing factors on the energy efficiency of OL networks and, in accordance with a certain, but permissible level of bias in the assessment of the modern vision of the directions for solving the stated problem, it should be emphasized that the development of such complexes, with controllable modes of their functioning, can and should rely on options that are as close as possible in terms of the technology of their functioning to the intellectual one. This, accordingly, requires a careful study of the state and formalization of modern tasks and ways of solving them, which should and can be assigned to new, comprehensively effective types of electric power systems OL of cities and settlements.

When implementing such a “project”, it should be taken into account that the structuring of project formats of OL schemes, as a rule, is carried out situationally, in accordance with the landscape, architecture of a particular city or settlement, as well as in accordance with and based on existing norms and standards [17], including in accordance with [18]. According to [18], “in cities and towns, industrial enterprises should provide for centralized control of outdoor lighting”.

In the list of current trends in the field of increasing efficiency in general and energy efficiency and reliability of OL in particular, a special place is occupied by the latest variants of the structures of their power supply systems (PSS) with distributed generation of electrical energy [19]. Such PSS provide both autonomous power supply to the electrical complexes of outdoor lighting [20, 21] and parallel power supply to the city grid [22, 23].

Nevertheless, for more correctness of the above interpretation, we note that, analyzing the results of the implementation of these types of PSS structures in the practice of a number of industrial and utility companies [6, 24], it is obvious that the technologically “bare version” of such PSS potentially energy efficient and synergistic in structure, in its final solution format, is not able to provide an opportunity to achieve the level of their energy efficiency to its maximum achievability, without the use of electricity control elements in their functioning technology.

According to the established practice of building OL structures existing in Ukraine, their PSS is carried out with a TN-S grounding system through power points from transformer substations of general PSS of a specific city or settlement. OL networks, having different execution structures, nevertheless consist of a number of sequentially connected sections – cascade variants [25].

The construction of OL networks today, as cascade options, provides for the practical possibility and what is implemented – regulation of the consumed electrical power of these complexes by turning them on in the evening (part of the lighting is turned off) and night (all lighting is turned on) modes of operation, for which the cascades have phases night and evening modes of operation.

In accordance with [25], urban outdoor lighting should be controlled from one central control center, but in large cities with obstacles in the terrain, it is possible to provide district control centers. In turn, outdoor lighting control systems should ensure that it is turned off within no more than 3 minutes.

Thus, it is obvious that the format of tasks for the search and development of new, modernly aimed at achieving the efficiency of outdoor lighting systems in settlements should logically be integrated into the basic standards of the relevant criteria-requirements for these electrical complexes.

Main material presentation. Substantiation of the methods used. Creating an effective intelligent outdoor lighting control system requires a thorough study that covers a wide range of methods. The initial stage involves collecting data related to the operation of the outdoor lighting network, such as energy consumption levels, traffic and vehicle data, and weather conditions. Then, using statistical methods, the data is analyzed to identify patterns, trends, and relationships, as well as to make further forecast. For intelligent control of outdoor lighting, a decision-making method based on fuzzy logic inference is used, which allows one, based on information about the operating conditions of the outdoor lighting network, to generate control of the current of lighting devices that will ensure maximum system efficiency.

Results and discussion. Networks of OL complexes of cities and settlements of the state are formats of related, or close to this definition, variants of structures [10, 11]. However, a number of cities have their own system, which forms a variable specificity of the structuring of OL networks. Often, it is this specificity that determines difficult additional problems and, first of all, regarding the energy efficiency indicators of OL as electric energy complexes, as well as the development of their control systems. One of the most difficult options in the queue for the formation of the structure and management system of OL systems is the city of Kryvyi Rih (Dnipropetrovsk region) [12].

In connection with this interesting moment, according to the complexity and scope of the expected research, as a scientific search, in the direction being analyzed, there is an analysis of the state of development of the OL structure, PSS parameters and levels of power consumption by the lighting complexes of this city, with its complexity and the peculiarity of the structures OL.

Analyzing the state of performance indicators of the functioning of the OL networks on the example of the city under consideration, it is reasonable and realistic to assert that over the past ten years, the system-forming operational parameters of the functioning of lighting complexes in the city have significantly improved due to the constant work on this issue by the relevant city structures. At the same time, taking into account the world experience, it is appropriate to state that the potential for further growth of the efficiency of the OL remains and should be realized.

At the same time, we should note that the structuring of the lighting scheme in the city of Kryvyi Rih is much more complicated than in most settlements of Ukraine. This is related both to the length of the city's streets, some of which reach several tens of kilometers, and to its landscape. The latter is difficult to format into a clear system or scheme, because the landscape of the city is interspersed with a lot of man-made disturbances.

The city has and is implementing a plan of measures to modernize the PSS complexes of the city's OL. Unfortunately, the fullness of these measures, although necessary and still limited local solutions, are not able to provide an opportunity to achieve the desired and at the same time achievable level of complex efficiency in general and energy efficiency in particular.

To confirm this postulate, we will conduct an analysis of the electrical and energy state of the OL of the same city of Kryvyi Rih, based on statistical materials obtained over the last 10 years. At the same time, we will assume, not without reason, that the forecast, based on the statistics of the forecasting values of such indicators and, most importantly, the development of appropriate solutions based on the received data, with their subsequent implementation in the practice of OL functioning, will allow one, by determining the variability of the construction of the corresponding schemes, to significantly affect the level energy efficiency OL.

Table 1 provides the values of the indicators of the levels of electricity consumption by street lighting in the city of Kryvyi Rih (Dnipropetrovsk region) in the period from 2014 to 2023.

Next, we will approximate the information presented graphically in order to highlight the trend – Fig. 1.

In the option being analyzed, there is obviously the use of an approximating polynomial of the second degree, which reflects the trend of the process development and is equal to

$$Y = -415,898x^2 + 4 \cdot 10^6x + 10^7. \quad (1)$$

Obviously, the polynomial meets the requirements of adequacy, because the coefficient of determination is 88.1 %.

Therefore, the resulting analytical dependence (1) can be applied to further determine the forecast.

We can also obtain the values of the forecast of electricity consumption levels by street lighting by using the corresponding program according to Table 2.

In this case, we get the calculated and visualized data – Fig. 2.

Table 1

Power consumption by street lighting

I. Installed electric capacity of the city lighting network (kW)			
2014	38,566.1	2019	45,755.5
2015	41,222.3	2020	45,755.5
2016	44,568.5	2021	45,755.5
2017	45,755.5	2022	45,755.5
2018	45,755.5	2023	45,755.5
II. Levels of electricity consumption by street lighting (kWh)			
2014	14,980,000	2019	17,331,494
2015	17,833,900	2020	18,030,988
2016	18,593,842	2021	17,475,465
2017	18,692,374	2022	8,686,635
2018	20,705,598	2023	7,634,690
III. Length of lighting networks (km)			
2014	1,582.7	2019	1,837.59
2015	1,622.4	2020	1,837.59
2016	1,733.3	2021	1,837.59
2017	1,835.56	2022	1,837.59
2018	1,837.59	2023	1,837.59
IV. Number of electrical substations in the network (pcs.)			
2014	541	2019	562
2015	552	2020	562
2016	552	2021	566
2017	512	2022	566
2018	562	2023	566

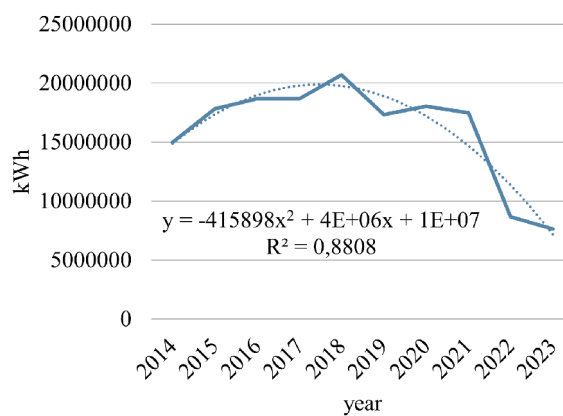

Fig. 1. Trend of power consumption by outdoor lighting in Kryvyi Rih in 2014–2023

It is easy to note that there is a tendency to decrease the values of the indicators. This is explained by the realities of today. It should also be noted that the forecast is a probabilistic indicator, the values of which may change depending on the relevant information.

It is appropriate, in today's realities, to compare the values of the forecast of the levels of electricity consumption by street lighting, using information until 2022, considering it as force majeure (Fig. 3).

By grouping the data, we visually note the decrease in electricity consumption by outdoor lighting.

Accordingly, we will get an analytical dependence on the trend. We have a polynomial of the second degree (Fig. 3)

$$Y = -250,169x^2 + 2 \cdot 10^6x + 10^7. \quad (2)$$

The coefficient of determination is 66.8 %, respectively.

That is, there is the expediency of building a forecast with the appropriate bindings from the Table 3 (Fig. 4).

We note the growth of forecast indicators, therefore it is logical to determine the comparison of forecast values with the initial information – 2014–2021 and 2014–2023 (Table 4).

It is easy to note that 2022 and 2023 contribute to the formation of the trend, as indicated by the difference in the values of the corresponding forecast indicators. Meanwhile, returning to the previous conclusions, we note that the indicators of 2022 and 2023, as well as the future year 2024, are not typical, since the mode of operation of the analyzed complexes was far from established by years until these periods. The “blame” for this

Table 2

Forecast of levels of electricity consumption by street lighting

Timeline, (years)	Value, kWh	Forecast, kWh	Low probability binding, kWh	Binding is high probabilities, kWh
2014	14,980,000	–	–	–
2015	17,813,900	–	–	–
2016	18,692,374	–	–	–
2017	18,692,374	–	–	–
2018	20,705,598	–	–	–
2019	17,331,494	–	–	–
2020	18,030,988	–	–	–
2021	17,475,465	–	–	–
2022	8,686,635	–	–	–
2023	7,634,690	7,634,690	7,634,690.00	7,634,690.00
2024	–	6,777,469.1	675,434.70	12,879,503.46
2025	–	5,920,248.2	–904,764.78	12,745,261.09
2026	–	5,063,027.2	–2,417,890.23	12,543,944.70

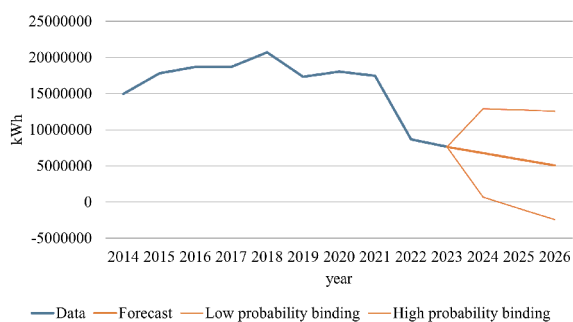

Fig. 2. Forecast of power consumption by street lighting in Kryvyi Rih

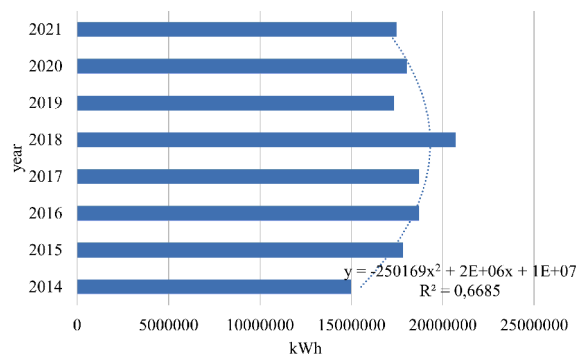

Fig. 3. Trend of power consumption by outdoor lighting in Kryvyi Rih in 2014–2021

Table 3

Forecast of levels of electricity consumption by street lighting

Timeline, (years)	Value, kWh	Forecast kWh.	Low probability binding, kWh.	Binding is high probabilities, kWh
2014	14,980,000	–	–	–
2015	17,813,900	–	–	–
2016	18,692,374	–	–	–
2017	18,692,374	–	–	–
2018	20,705,598	–	–	–
2019	17,331,494	–	–	–
2020	18,030,988	–	–	–
2021	17,475,465	17,475,465	17,475,465.00	17,475,465.00
2022	–	17,879,421	14,582,592.48	21,176,249.16
2023	–	18,077,403	13,954,388.74	2,220,0417.48
2024	–	18,275,385	13,464,381.97	23,086,388.85
2025	–	18,473,368	13,059,624.20	23,887,111.20
2026	–	18,671,350	1,271,4180.96	24,628,519.03

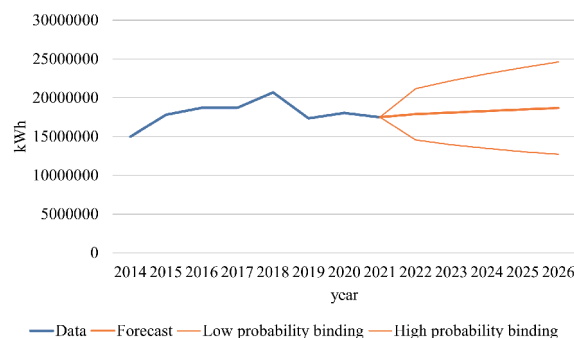

Fig. 4. Forecast of power consumption by street lighting in Kryvyi Rih

reduction is the introduction of curfews, during which the street lighting systems did not function, and the disabling of significant areas of these complexes due to their damage as a result of the corresponding actions of the aggressor country. It should also be noted that forecasts are probabilistic indicators, the values of which may change depending on relevant information.

However, even with such limited information, there is obviously a fact that with the constant length of power transmission lines, electric capacities and other parameters of lighting networks in the analyzed city, the levels of electricity consumption by OL complexes have a tendency to fluctuate, which can be characterized as stochasticity.

Table 4

Comparison of forecast values of electricity consumption levels for outdoor lighting in Kryvyi Rih (Dnipropetrovsk region) in 2014–2021 and 2014–2023

Forecast \ Period	2014–2021	2014–2023	Δ
2024	18,275,385	6,777,469.1	11,497,916.33
2025	18,473,368	5,920,248.2	12,553,119.54
2026	18,671,350	5,063,027.2	13,608,322.76

Thus, the difference between the levels of electricity consumption by the city’s OL complexes in 2019, compared to 2018, amounted to (–) 17.3 %, and in 2020 to 2019 – about (+) 4 %, and in 2021 to 2020 – about (–) 3 %.

Such fluctuations, even at insignificant levels, lead to inconsistency in the plan–fact allocation of funds from local budgets for the payment of electricity consumed for street lighting.

Fig. 5 shows a fuzzy outdoor lighting control system (FOLCS).

It contains the power part, which is represented by lighting devices with LED drivers, two power sources – the power grid and batteries (the latter are shown in general, since they can be both group and individual) and a switching device that switches one or another source to lighting installations; the measuring part, which includes illuminance sensors (IL) near each LED lamp and traffic intensity sensors (TR) near traffic lights at both ends of the road; the control part, which is represented not only by the fuzzy inference (FIS) Mamdani system, but also by the units of generalization of information about illumination (UGII) and road traffic (UGIRT) coming from sensors, the database of electric energy tariffs (DEET) and the unit of battery charge estimation (UBCE).

FOLCS works like this. The illuminance and traffic intensity values measured by the corresponding IL and TR sensors are submitted to the UGII and UGIRT summarization blocks, which are then, together with the electricity tariff for the given hour from the relevant database (DEET), transferred to the Mamdani FIS system. FIS is carried out, which gives the value of PWM switching for LED drivers of lighting devices and a recommendation for the use of one or another power source. If it is recommended to connect the battery, then the battery charge evaluation unit (UBCE) determines the state of charge,

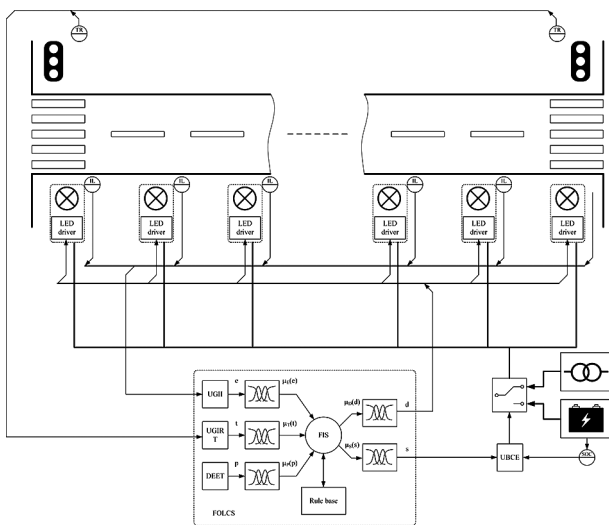

Fig. 5. Fuzzy outdoor lighting control system:

UGII – illumination generalization unit; UGIRT – traffic intensity generalization unit; DEET – electricity tariff database; UBCE – battery charge evaluation unit; IL – illuminance sensor; TR – vehicle traffic intensity sensor

if it is sufficient to power the lighting devices, then the battery is connected, if not, the FIS recommendation is ignored.

The data obtained during simulation of the FOLCS with ten LED lamps operation in summer and winter are shown in Table 5. The operating schedules of the Mamdani FIS system in winter and summer are shown in Figs. 6–9. In the power source selection diagrams, if the value is below 0.5, then the power supply of outdoor lighting devices is provided by the battery and the grid, otherwise – only from the grid.

The use of combined power supply for lighting devices significantly reduces electricity consumption. On winter nights, when powered only by the grid, consumption is reduced by 0.09 and 0.07 kWh at intervals of 5 and 10 minutes between

Table 5

Results of simulation of FOLCS operation

Period	Electricity consumption, kWh					
	Existing system/cutoff	Existing system/0.5P	FOLCS with power supply from the grid		FOLCS with power supply from the grid/solar power plant	
	–	–	$\Delta 5$ min	$\Delta 10$ min	$\Delta 5$ min	$\Delta 10$ min
Summer	4.03	5.53	2.57	2.61	1.39	1.37
Winter	8.03	11.03	7.94	7.96	2.46	2.16

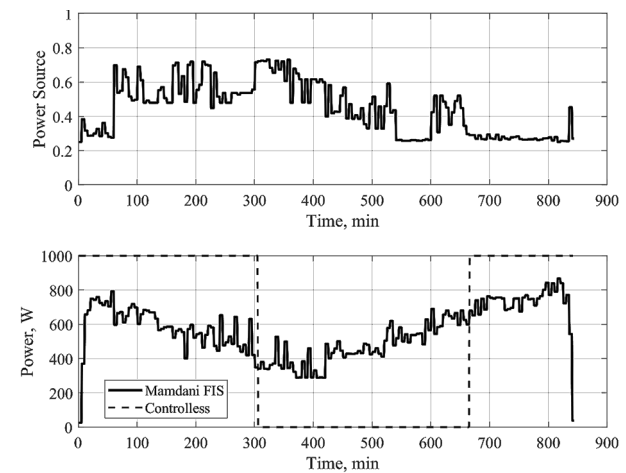

Fig. 6. Simulation of FOLCS with 10 LED lamps on a winter night (step 5 min)

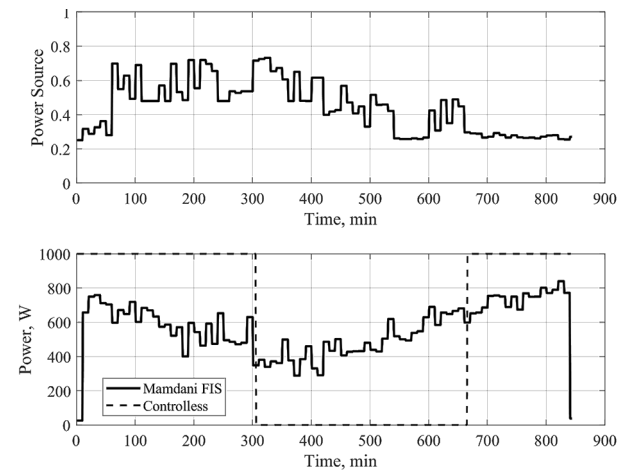

Fig. 7. Simulation of FOLCS with 10 LED lamps on a winter night (step 10 min)

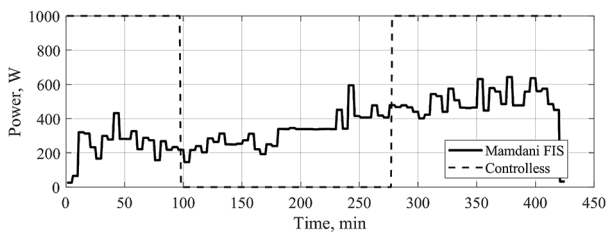
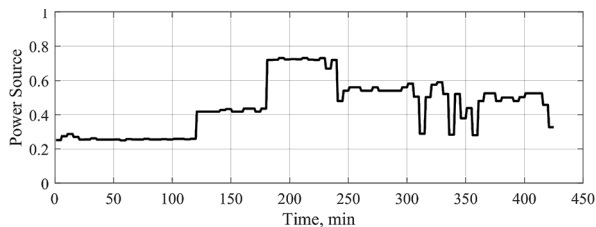

Fig. 8. Simulation of FOLCS with 10 LED lamps on a summer night (step 5 min)

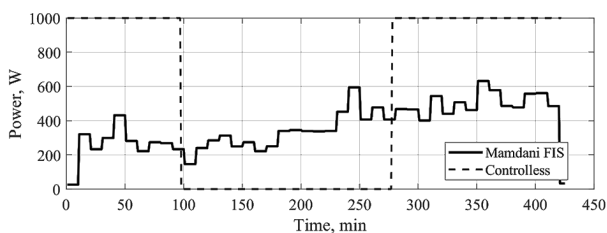
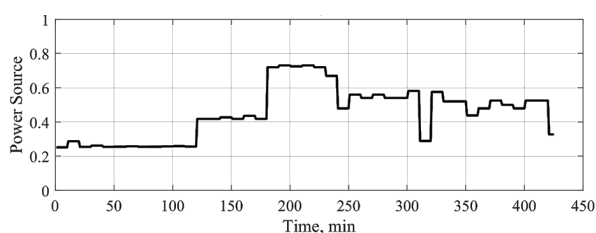

Fig. 9. Simulation of FOLCS with 10 LED lights on a summer night (step 10 min)

generating controls, respectively, compared to a system without controls, where the lighting network is turned off for 6 hours. If during these 6 hours the lighting installations consume only 50 % of the power, the reduction is 3.09 and 3.07 kWh. When powered by the grid or a solar power plant, the reduction reaches 5.57 and 5.87 kWh and 8.57 and 8.87 kWh.

In summer, the situation is similar. Power supply only from the grid can reduce electricity consumption by 1.46 and 1.42 kWh, respectively, compared to an uncontrolled system and turning off the lights for 3 hours. Compared to 50 % electricity consumption, the reduction is 2.96 and 2.92 kWh. With the combined power supply, the reduction is 2.64 and 2.66 kWh, and 4.14 and 4.16 kWh.

The reduction of energy consumption in winter in the FOLCS system with grid power supply is small compared to the uncontrolled system and complete disconnection of outdoor lighting. This is because the interval of operation without energy consumption by lighting installations in winter is longer than in summer. Although the savings are insignificant, they are there. Therefore, the FOLCS can be applied.

The study of the impact of the discrete step on the power consumption of the FOLCS showed that it usually does not have a significant impact. For example, when powered only by the grid, the difference in power consumption in winter is 0.02 kWh and in summer about 0.04 kWh. In summer, with a combined power supply, the difference for the analyzed steps was 0.02 kWh.

A significant difference in consumption is observed only when powered by a solar panels or the grid in winter, when the

difference is 0.3 kWh when comparing 5 and 10 minute increments. These data were obtained by comparing the FOLCS with an uncontrolled and completely disconnected lighting system for 6 hours. For an uncontrolled system with 50 % of the lighting devices turned off, the electricity consumption at different steps is not very different. This is due to the fact that during the analyzed steps, the illumination and traffic do not change dramatically.

Based on the research, it can be concluded that FOLCS is an energy efficient system. At the same time, specialized utility companies of cities and settlements, responsible for lighting networks, are recommended not only to think about replacing light sources with more energy-efficient ones, but also about introducing alternative power sources, such as solar panels. This, in combination with FOLCS, will provide an opportunity to save on electricity costs, which is an urgent issue in modern conditions.

Conclusions. The existing structures and modes of operation of electric networks of outdoor lighting of cities and settlements of Ukraine in the modern vision of the complex of necessary and possible levels of achievement of their operation are examples of electric power systems with insufficient electric energy efficiency and a low level of reliability both in trivial modes and, what is especially relevant, in current conditions in the country.

Forecasting of electricity consumption until 2026 in the main possible scenarios: stabilization, gradual increase or gradual decrease. If the length of power transmission lines, electric capacities and other parameters of lighting networks in the analyzed city remain constant, the levels of electricity consumption by outdoor lighting complexes have a tendency to fluctuate, which can be characterized as stochasticity.

An improved fuzzy control system for the electrical complex of outdoor lighting in cities and settlements, which, in addition to the level of illumination and traffic intensity, also takes into account the electricity tariff when generating the control voltage or current (depending on the type of LED driver) of the lighting installation. The system also provides a recommendation on the choice of a power source for the lighting installation from the grid or simultaneously from the grid and from batteries charged by the solar panels.

Simulation of the outdoor lighting system, which was carried out on the example of an operational part of the road illuminated by ten LED lamps with the power of 100 W for summer and winter night with different discrete control steps, confirms the possibility of achieving the efficiency of outdoor lighting when using the proposed control option. The controlled system with a combined power supply is more efficient, as it allows for a significant reduction in electricity consumption by the outdoor lighting network in summer and winter nights compared to the existing options.

References.

- Hovorov, P. P., Hovorov, V. P., & Kindinova, A. K. (2021). Automation of control of power supply and lighting systems in cities. *Visnyk Vinnytskoho Politekhnicznego Instytutu*, 5, 58-63. <https://doi.org/10.31649/1997-9266-2021-158-5-58-63>.
- Drubetska, T. I., & Mitiaiev, D. M. (2023). Study of lighting methods and development of recommendations for their improvement. *Enerhetyka: ekonomika, tekhnolohii, ekolohiia*, 1, 109-116. <https://doi.org/10.20535/1813-5420.1.2023.276070>.
- Ministry for Communities and Territories Development of Ukraine (n.d.). *The state of outdoor lighting in Ukraine in 2023*. Retrieved from <https://mtu.gov.ua/files/%D0%90%D0%9D%D0%90%D0%9B%D0%86%D0%A2%D0%98%D0%9A%D0%90%202023.docx>.
- Suvorova, K. I., & Hurakova, L. D. (2018). *Current lighting systems as energy conservation resource. Municipal Economy of Cities*, 7(146), 121-126. <https://doi.org/10.33042/2522-1809-2018-7-146-121-126>.
- Ruzhytskyi, A. (2021). Problems of outdoor lighting enterprises in settlements and ways to solve them. *Economic Synergy*, 1, 23-28. <https://doi.org/10.53920/ES-2021-1-3>.
- Tulchynska, S. O., & Chornii, B. P. (2016). Diagnostics of the main components of the strategic potential of electricity distribution enter-

prises. *Ekonomichniy Visnyk NTUU "Kyivskiy politekhnichnyi instytut"*, 13. <https://doi.org/10.20535/2307-5651.13.2016.80119>.

7. Lavric, A., & Popa, V. (2013). A Traffic Prediction Algorithm for Street Lighting Control Efficiency. *Journal of Applied Computer Science & Mathematics*, 7(2), 13-17. <https://doi.org/10.4316/JACSM.201302002>.

8. Gagliardi, G., Lupia, M., Cario, G., Tedesco, F., Cicchello Gaccio, F., Lo Scudo, F., & Casavola, A. (2020). *Advanced Adaptive Street Lighting Systems for Smart Cities*. *Smart Cities*, 3(4), 1495-1512. <https://doi.org/10.3390/smartcities3040071>.

9. Nefedov, E., Maksimainen, M., Sierla, S., Flikkema, P., Yang, C.-W., Kosonen, I., & Luttinen, T. (2014). Energy efficient traffic-based street lighting automation. *2014 IEEE 23rd International Symposium on Industrial Electronics*, 1718-1723. <https://doi.org/10.1109/ISIE.2014.6864874>.

10. Official portal of Kyiv (n.d.). *Outdoor lighting*. Retrieved from https://kyivcity.gov.ua/navkolyshnie_seredovyshe_mista/vu-lychne_osvitlennia/zovnishnie_osvitlennia.

11. Suspilne Poltava (n.d.). *Outdoor lighting schedule changed in Poltava community*. Retrieved from <https://suspilne.media/poltava/540495-v-poltavskij-gromadi-zminili-grafik-zovnisnogo-osvitlennia>.

12. Rudana (n.d.). *From October 1, the schedule of outdoor street lighting will be changed in Kryvyi Rih*. Retrieved from <https://rudana.com.ua/news/z-1-zhovtnya-u-kryvomu-rozi-zmyniat-grafik-zovnisnogo-osvitlennya-vulyc>.

13. Elejoste, P., Angulo, I., Perallos, A., Chertudi, A., Zuazola, I. J. G., Moreno, A., ..., & Villadangos, J. (2013). An Easy to Deploy Street Light Control System Based on Wireless Communication and LED Technology. *Sensors*, 13(5), 6492-6523. <https://doi.org/10.3390/s130506492>.

14. Mary, M. C. V. S., Devaraj, G. P., Theepak, T. A., Pushparaj, D. J., & Esther, J. M. (2018). Intelligent Energy Efficient Street Light Controlling System based on IoT for Smart City. *2018 International Conference on Smart Systems and Inventive Technology (ICSSIT)*, 551-554. <https://doi.org/10.1109/ICSSIT.2018.8748324>.

15. Abdullah, A., Yusoff, S. H., Zaini, S. A., Midi, N. S., & Mohamad, S. Y. (2019). Energy efficient smart street light for smart city using sensors and controller. *Bulletin of Electrical Engineering and Informatics*, 8(2), 558-568. <https://doi.org/10.11591/eei.v8i2.1527>.

16. Twesigye, G., Ngenzi, A., & Ndashimye, E. (2022). An Embedded Fuzzy Logic Based Smart Street Lighting System. *2022 IEEE Nigeria 4th International Conference on Disruptive Technologies for Sustainable Development*, 1-5. <https://doi.org/10.1109/NIGERCON54645.2022.9803089>.

17. Liga Zakon (n.d.). *DBN B.2.5-28:2018 Natural and artificial lighting*. Retrieved from <https://lps.ligazakon.net/document/DBN00078>.

18. *Rules for the arrangement of electrical installations. Official publication*. Kyiv: Ministry of Energy and Coal Industry. Retrieved from <https://zakon.isu.net.ua/sites/default/files/normdocs/pue.pdf>.

19. de Melo, M. F., Vizzotto, W., Kirsten, A. L., Dalla Costa, M., & Garcia, J. (2013). Hybrid system of distributed power generation and street lighting based on LEDs: Grid connection. *2013 Brazilian Power Electronics Conference*, 1100-1106. <https://doi.org/10.1109/COBEP.2013.6785252>.

20. Nasser, M., & Hassan, H. (2023). Assessment of standalone streetlighting energy storage systems based on hydrogen of hybrid PV/electrolyzer/fuel cell/ desalination and PV/batteries. *Journal of Energy Storage*, 63, 106985. <https://doi.org/10.1016/j.est.2023.106985>.

21. Ali, M., Orabi, M., Abdelkarim, E., Qahouq, J. A. A., & Aroudi, A. E. (2011). Design and development of energy-free solar street LED light system. *2011 IEEE PES Conference on Innovative Smart Grid Technologies – Middle East*, 1-7. <https://doi.org/10.1109/ISGT-MidEast.2011.6220812>.

22. Panguloori, R., Mishra, P., & Kumar, S. (2013). Power distribution architectures to improve system efficiency of centralized medium scale PV street lighting system. *Solar Energy*, 97, 405-413. <https://doi.org/10.1016/j.solener.2013.08.034>.

23. de Melo, M. F., Vizzotto, W. D., Quintana, P. J., Kirsten, A. L., Dalla Costa, M. A., & Garcia, J. (2015). Bidirectional Grid-Tie Flyback Converter Applied to Distributed Power Generation and Street Lighting Integrated System. *IEEE Transactions on Industry Applications*, 51(6), 4709-4717. <https://doi.org/10.1109/TIA.2015.2451115>.

24. Sinchuk, I., Mykhailenko, O., Kupin, A., Ilchenko, O., Budnikov, K., & Baranovskyi, V. (2022). Developing the algorithm for the smart control system of distributed power generation of water drainage complexes at iron ore underground mines. *2022 IEEE 8th International Conference on Energy Smart Systems*, 116-122. <https://doi.org/10.1109/ESS57819.2022.9969263>.

25. Horshkov, V. V. (2023). *Energy-efficient electrical complex with elements of intelligent control of the process of settlements street lighting: monograph*. iScience Sp. z o.o. Retrieved from <https://sciencecentrum.pl/wp-content/uploads/2023/01/%D0%93%D0%BE%D1%80%D1%88%D0%BA%D0%BE%D0%B2%20%28web%29.pdf>.

Підвищення ефективності функціонування електротехнічних комплексів зовнішнього освітлення

О. М. Сінчук¹, Т. М. Берідзе¹, О. Ю. Михайленко^{*1},
В. В. Горшков¹, М. В. Рогоза², Р. Стржелецькі³

1 – Криворізький національний університет, м. Кривий Ріг, Україна

2 – Національний технічний університет «Дніпровська політехніка», м. Дніпро, Україна

3 – Гданський технологічний університет, м. Гданськ, Республіка Польща

* Автор-кореспондент e-mail: mykhailenko@knu.edu.ua

Мета. Отримання математичних виразів, котрі, використовуючи наявну інформацію, дозволять прогнозувати на декілька років наперед рівні споживання електроенергії електричною мережею зовнішнього освітлення міста в основних можливих сценаріях її розвитку, а також у розробці енергоефективної інтелектуальної системи керування електротехнічним комплексом освітлювальних мереж.

Методика. Створення ефективної інтелектуальної системи керування зовнішнім освітленням передбачає застосування наступних методів. Спочатку, використовуючи емпіричний метод вимірювання, отримується інформація про освітленість, рівні споживання електроенергії, авто- й пішоходний трафік. Для виявлення закономірностей і взаємозв'язків між вимірними величинами, а також наступного прогнозування, застосовуються статистичні методи. Для інтелектуального керування зовнішнім освітленням використовується метод прийняття рішень, що базується на нечіткому логічному висновку. Він дозволяє, спираючись на інформацію про умови роботи мережі зовнішнього освітлення, визначити рекомендоване значення струму або напруги (залежно від принципу керування) освітлювальних приладів і потрібне джерело живлення. Такий підхід забезпечить максимальну ефективність системи.

Результати. Отримані аналітичні залежності для прогнозування рівнів споживання електричної енергії, що будуються, базуючись на даних різних часових проміжків, мають, відповідно, коефіцієнти детермінації 66,8 і 88,1%. Здійснене моделювання роботи нечіткої системи керування енергоспоживанням зовнішнього освітлення на прикладі частини дороги, що експлуатується та освітлюється десятками LED-світильниками з індивідуальною потужністю 100 Вт для літньої та зимової ночі з різними дискретними кроками керування. Це підтверджує можливість досягнення ефективності зовнішнього освітлення при застосуванні запропонованого варіанту керування. Ефективнішою є керована система з комбінованим живленням, котра дозволяє знизити споживання електроенергії в літню й зимову ночі більш ніж на 70% у порівнянні з традиційними схемами керування.

Наукова новизна. Удосконалена нечітка система керування електротехнічним комплексом зовнішнього освітлення міст, у якій при генерації величини керуючої дії для LED-драйвера й визначенні раціонального джерела живлення (електромережа або мережа та акумулятор) освітлювальних приладів, окрім рівня освітленості й величини автотрафіку, урахується тариф на електроенергію.

Практична значимість. Розроблена архітектура системи керування споживанням електроенергії електроприймачами освітлювальних мереж на базі алгоритму нечіткого логічного висновку, котра рекомендується до застосування для забезпечення підвищення енергоефективності цього класу комунальних споживачів.

Ключові слова: вуличне освітлення, енергоспоживання, прогнозування, нечітке керування, моделювання

The manuscript was submitted 04.06.24.