

Influence of local bush wear on water lubricated sliding bearing load carrying capacity

Wojciech Litwin wliwtin@pg.gda.pl

Gdansk University of Technology, Faculty of Ocean Engineering and Ship Technology, ul. Narutowicza 11/12, 80-233 Gdansk, Poland

Keywords: water lubricated bearings, propeller shaft bearings, marine bearings, bush wear

Abstract (100 words)

One of main problems concerning water-lubricated bearings is their durability. There are known cases of bearings with life time measured in decades, and some, whose refurbishment was necessary just days after start-up.

Obtaining stable fluid film friction plays key role in the durability of these bearings. Unfortunately, their load-carrying capacity is limited due to water's low-viscosity.

The conducted experimental research demonstrated that in water-lubricated bearing working under fluid lubrication regime, noticeable bush wear occurred at the edges. Detailed analysis of this phenomenon made it possible to propose a method for calculating load capacity of sliding bearings which provides for local bush wear.

1. Introduction

Water-lubricated bearings are finding increasingly wide use in various branches of industry. As such, they may also be encountered in marine propulsion systems. They are also increasingly frequently employed in bearing systems of water turbine shafts and water pumps. This rising popularity is due to a number of reasons. First of all, their simple construction has direct impact on the level of pricing which is usually quite attractive. Furthermore, this type of technology fits well into the trend of environmentally-friendly solutions since water-lubricated bearings do not constitute a source of pollution. The lubricating agent consists of water circulating in a closed system and in the simplest bearings it may even be taken directly from the surroundings.

For many years, water-lubricated sliding bearings have been a subject of both experiment-based and theoretical research in various scientific centers and R&D departments of leading companies. Synthetic rubber - NBR, was one of the first extensively tested materials employed in the production of water-lubricated bearing bushes and it remains in popular use till today [1][2][3][4]. Elastic, polymer bushes have been successfully employed for many years in the bearings of turbine

rotors, pumps and marine propeller shafts [5][6][7]. The adoption of well known, extensively used materials and combining them in a three-layer bearing gave surprisingly good results in terms of low motion resistance and the ability to continue working under emergency breakdown conditions [8][9]. Composite materials have also been successfully used for a number of years [10]. Elastic, water-lubricated foil bearings constitute a very interesting modern solution [11]. They have excellent vibration dampening qualities and compensate for bush-shaft misalignment. On the other end of the spectrum, there are the recently developed completely new materials of exceptional rigidity which are employed in bush manufacturing. These are mostly sintered metals [12] and ceramics [13]. However, their properties require practically ideal alignment of bush and shaft, and for this reason they have not yet found use in the bearing systems of marine propeller shafts.

Numerous examples of successful application of water-lubricated bearings are known. Devices equipped with rubber or polymer bearings function reliably for many years. However, there are certain exceptions - a fact which bearing manufacturers do not quite readily admit. There exist known cases of excessive bearing wear occurring as soon as just after a few hours of work. Carrying out a repair, which usually consist of bush replacement and shaft regeneration is expensive and time consuming. Such breakdown may be caused by a number of factors, with typical ones being:

- No flow of water absorbing the heat generated in friction zone, possibly leading to overheating in short time.
- Shaft vibrations which may cause permanent break of the lubricating film while the shaft hitting the bush may result in delamination of the composite bush material.
- Bearing misalignment resulting from improper assembly, deformation of elastic ship hull or temperature changes cause unfavorable conditions for fluid film friction which limit the bearing's load carrying capability and in extreme cases result in the shaft contact with bush edge causes intense local wear of the journal and the bush.
- Bush geometry which is unfavorable for liquid friction, especially incorrect location of lubrication grooves may cause the bearing to work under mixed lubrication regime.
- Excessive bearing clearance - due to concerns that water-absorbing, swelling bush may seize itself on the shaft, this clearance is frequently increased to theoretically safe size. Unfortunately, this significantly decreases the bearing's hydrodynamic load capacity.

2. Problem

Correct friction pair selection, as well as specifically designing the bearing for work under fluid film lubrication regime is of key importance to the durability of any water-lubricated sliding bearing.

It is thought that in those solutions where incidence of considerable shaft misalignment is likely it is most advantageous to use elastic bushes made of NBR or polymers. Such a cases were studied and published in the past [14][15][16][17]. In fact, this allows for avoiding stresses concentration at the bush edge, the appearance of which is usually responsible for intensive bush and journal wear. However, the conducted theoretical research (EHL model) demonstrates that the bush's elasticity module does have significant impact on the bearing's hydrodynamic load capacity (Fig 1 and 2) [18].

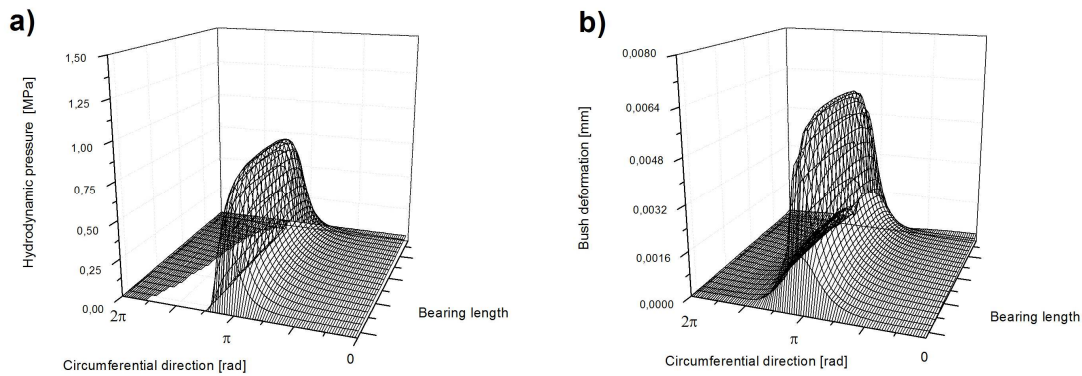

Fig. 1. Calculated hydrodynamic pressure in bearing inner space (a) and deformation of elastic bush bearing (b); journal diameter 100 mm, bearing clearance 0.4 mm, bush length 300 mm, calculated bearing load-carrying capacity 5.1 kN

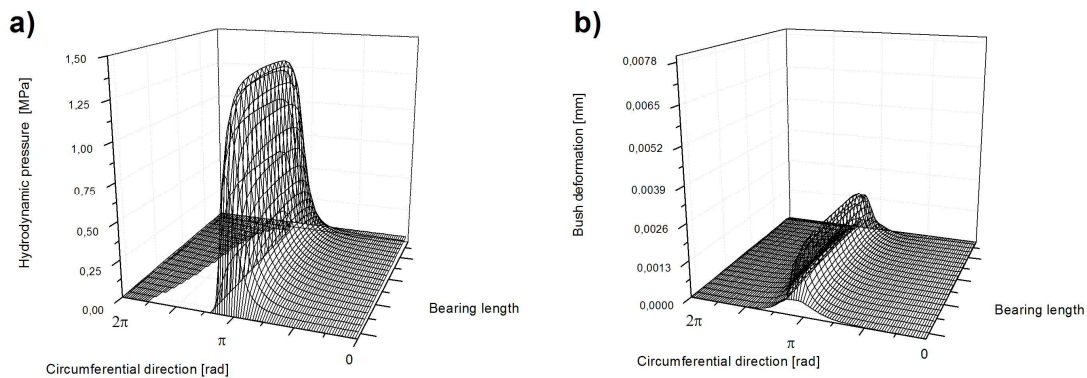

Fig. 2. Calculated hydrodynamic pressure in bearing inner space (a) and deformation of rigid, composite bush bearing (b); journal diameter 100 mm, bearing clearance 0.4 mm, bush length 300 mm, calculated bearing load-carrying capacity 6.3 kN

The lower load capacity of elastic bush bearings results from the size of elastic deformation of bush surface under hydrodynamic pressure, which may be greater than the assumed thickness of the lubricating film (Fig. 1b).

In case of typical sliding bearings lubricated by low-viscosity fluid, the minimum lubricating film thickness is estimated at only a few micrometers. In calculations, the accepted value often oscillates in the 5 to 7 μm range depending on the surface smoothness of journal and bush. Furthermore, it turns out that it is difficult to obtain a convergent result between calculations done according to the hydrodynamic lubrication theory for an elastic bush (EHL model) for lower values when the value of

elastic deformation of the bush surface exceeds that of the film thickness. In such cases, ideal alignment is frequently assumed, while in fact it is exceptionally rare due to manufacturing faults or improper assembly, as well as deformations in construction structure which may occur, for instance, in ship hulls at rough seas or in turbines under the impact of the working fluid.

Author's own experiment-based research demonstrated that a bearing works under a fluid film lubrication regime at much higher loads than indicated by calculation results obtained using the theory of hydrodynamic lubrication providing for elastic bush deformation – the EHL method [12][19][20].

Detailed analysis of the bearing's bush conducted after the completion of experimental tests determined the presence of wear at its edges, i.e. in those locations where the hydrodynamic pressure falls due to the outflow of the lubricating agent to the bearing's sides. Therefore, it was concluded that in reality the bearing reaches its maximum hydrodynamic capacity when, as a result of a running-in process, the sliding surface of the bush becomes smooth and when wear takes place at the bush edges (Fig. 3). This local bush wear allows the shaft journal to close the distance to the bush surface deformed as a result of hydrodynamic pressure (Fig. 3c). The lubricating gap thickness decreases in this way from $h_{1_{\max}}$ to $h_{2_{\max}}$ causing rise in the bearing's hydrodynamic load capacity.

Numerous authors have tackled the subject of modeling wear in water-lubricated bearings, however these efforts dealt mostly with wear occurring in the bearing operating under mixed-lubrication regime [21][22][23][24].

3. Calculations

In order for the calculation model to represent as closely as possible the phenomena witnessed during experiment-based research, it was decided to modify the calculation method to provide for the material loss at bush's edges (Fig. 3). It was expected that the proposed calculation model, named EHL+LW, would allow to obtain more realistic hydrodynamic pressure calculation results, especially when it came to determining true-to-life load capacity of the bearing.

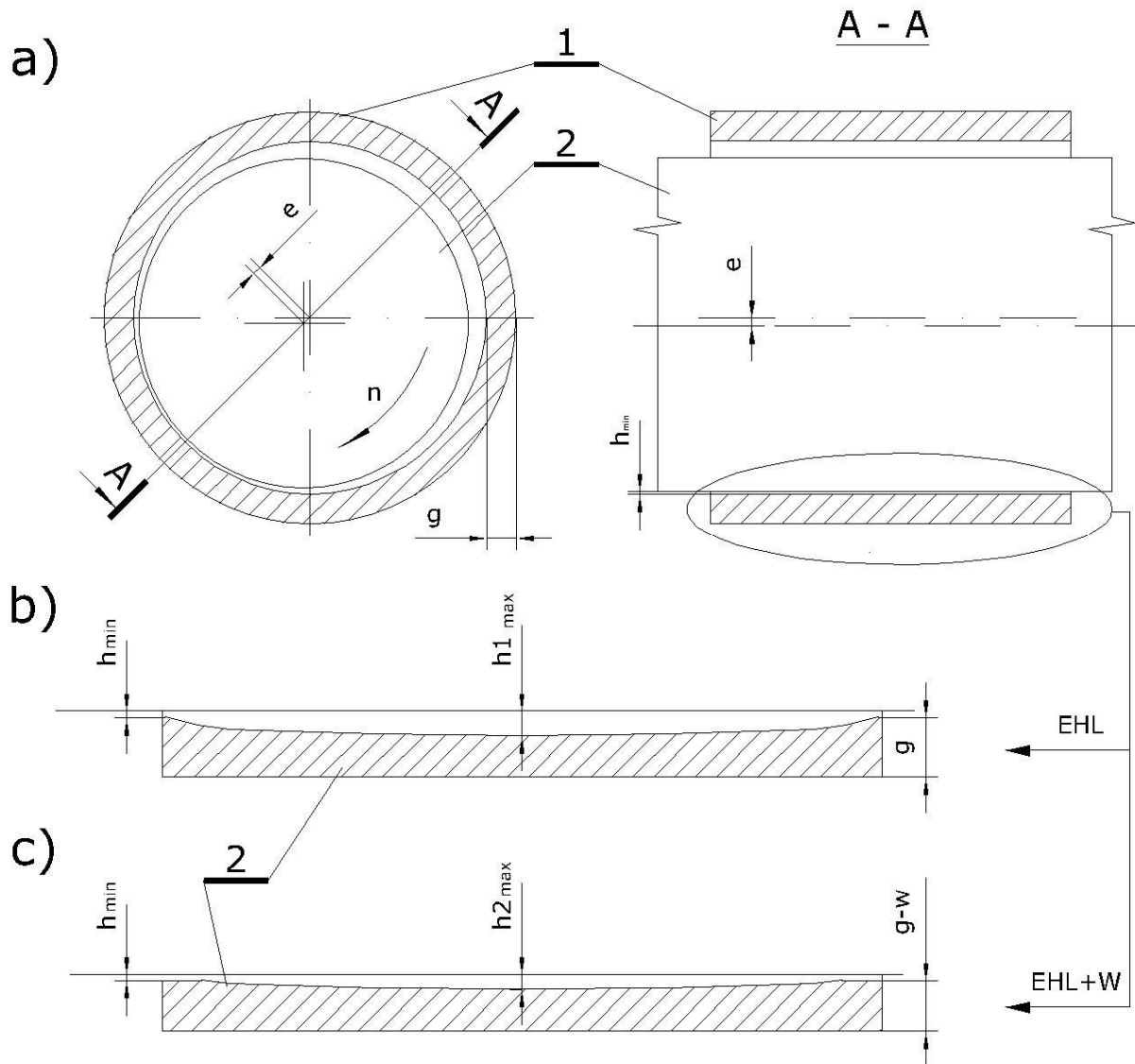

Fig. 3. Impact of local wear effect on minimum lubricating film thickness, key to the proposed EHL+LW method ; 1 – bush, 2 – shaft; e – eccentricity, g – bush wall thickness, w – extent of wear , h_{min} – minimum lubricating film thickness, h_{max} – maximum lubricating film thickness stemming from bush deformation due to impact of hydrodynamic pressure field; b) longitudinal cross-section through lubrication gap for model EHL; c) longitudinal cross-section through lubrication gap for model EHL+LW

Figure 3 presents the effect of local bush wear when the minimum assumed lubricating film thickness h_{min} remains unchanged despite local wear, while the maximum lubricating film thickness h_{max} decreases due to elastic deformation of the bush under the impact of pressure field. This effect is a result of local bush wear when its thickness decreases by the value w (Fig. 3 b – c).

The theory of hydrodynamic lubrication providing for elastic deformation of the bush (model EHL) was employed in the calculations, with addition of a module which modified the bush geometry under the impact of pressure and introduces loss – the bush wear (Fig.4).

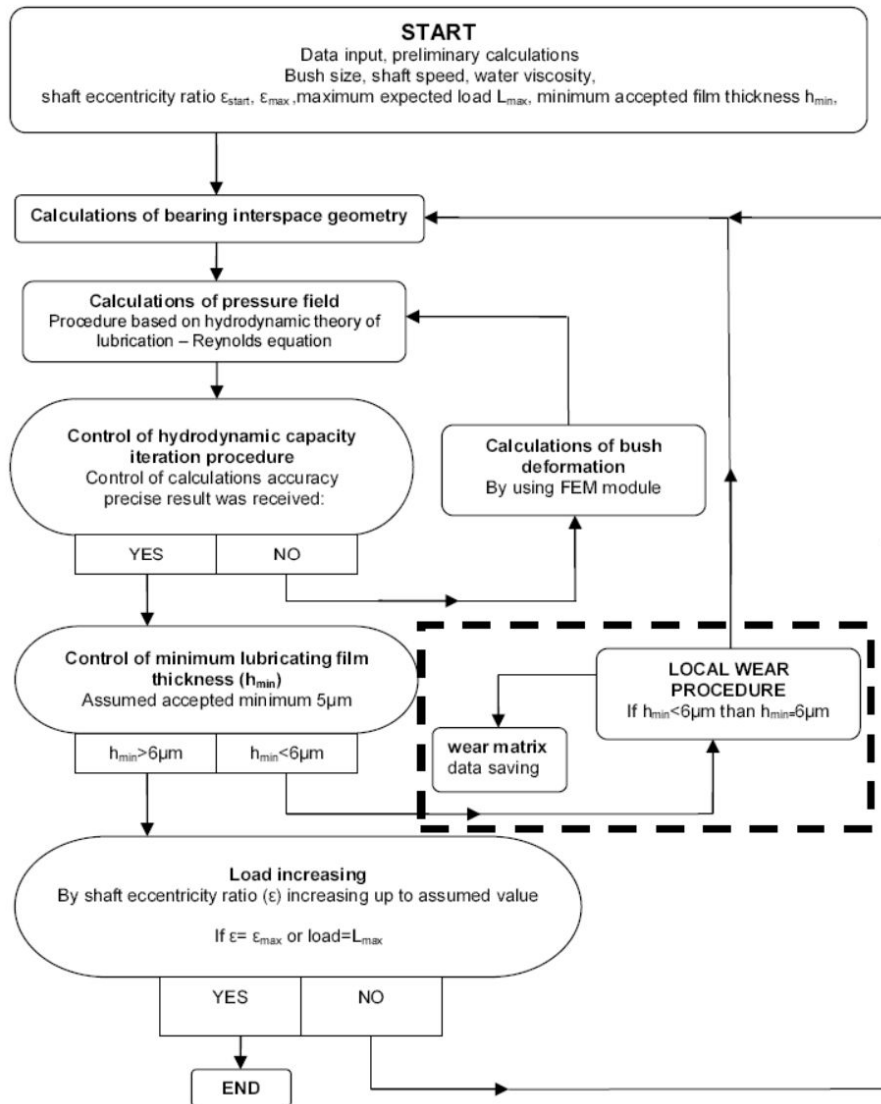

Fig. 4. Diagram presenting the proposed EHL+LW calculation method, which allows for computing bearing's maximum hydrodynamic load capacity for the adopted minimum lubricating film thickness. The fragment indicated by dotted line is connected with local wear area calculations

Through successive iterations the program computes the bearing's load capacity for the minimum, assumed lubricating film thickness. The calculations are initiated from the value of $10\ \mu m$. Once the results are obtained and recorded, the program carries out succeeding iteration for the lubricating film thickness decreased by $1\ \mu m$.

The bush wear module is activated when the lubricating film thickness is less than $6\ \mu m$. At this point, the bush geometry is modified by removing a $1\ \mu m$ thick layer of material at the bush edges. The area of wear, as well as the pressure field and the load capacity for the modified bearing geometry are recorded (Fig.6).

The value of assumed minimum lubricating film thickness at which no wear occurs is $6\ \mu m$. On the basis of the conducted experiments, it can be stated that it is extremely difficult to determine the thickness of the lubricating film despite using advanced equipment [11-14]. Usually the journal of

bearing working under fluid film lubrication conditions moves along few micrometers wide, oval orbit. However, it is hard to find an actual reference point – the clearance circle, since bush materials are elastic and a momentary deformation of the bush is hard to identify. Theoretical works conducted for bearings with journal diameter of 100 mm demonstrated, that it is usually hard to obtain convergence solution for lubricating films thinner than 5 μm , as well as for elastic bushes with modules of elasticity below 1500 MPa.

The calculations are continued until the wear loses its local character and appears along the entire bush length (Fig. 6 d).

4. Results

The executed calculations were done for bearings of dimensions similar to those which had been the object of experiment-based research in the past. Table 1 presents the data.

Table 1. Data adopted for calculations

No.	Parameter	Value
1	Journal diameter / Bush length / Diameter clearance	100 / 300 / 0.2 ÷ 0.6 mm
2	Bush material / Elasticity module	PET / 1500 MPa
3	Shaft rotation speed	3 and 11 rev/s

The graphs presented below illustrate selected calculation results. Figure 5a presents the computed distribution of hydrodynamic pressure in the bearing, as well as deformation area of the elastic bush (Fig.5b). The calculations were carried for the maximum allowed bearing load of approximately 5 kN. In successive iterations, the program increased the eccentricity (ϵ) and in this way decreased the thickness of the lubricating gap (h_{\min}). This forced the process of eliminating bush layers in the locations where the gap thickness was below the assumed 6 μm . Four selected stages of bush wear development are illustrated. At first, the wear is hardly noticeable (Fig. 6a). After seven successive iterations, it already reaches the level of 4 μm (Fig. 6b). Following completion of the sixteenth iteration, the wear reaches its maximum allowed value of approximately 16 μm (Fig. 6c). During the computation of subsequent, deeper wear it becomes apparent that a layer of material has been removed along the entire bush width (Fig. 6d). Therefore, at this point the wear loses its local character and no further calculations are conducted. In the analyzed case, the maximum load capacity of the bearing increased by approximately 25% (Fig. 7, 8).

The calculations for two journal speeds of 3 and 11 rev/s were conducted in a similar way, as were the ones for varying bearing clearances of 0.2, 0.4 and 0.6 mm. The results of the calculated load capacity are presented in graph form (Fig. 8.).

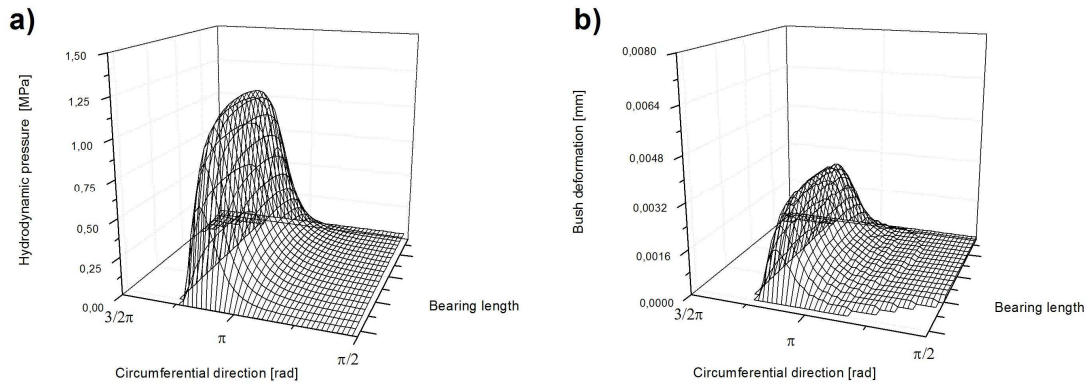

Fig. 5. Calculated hydrodynamic pressure in bearing inner space (a) and deformation of elastic bush made of PET using EHL method (b); journal diameter 100mm, bearing clearance 0.4 mm, bush length 200 mm, bearing load-carrying capacity app. 4.5 kN

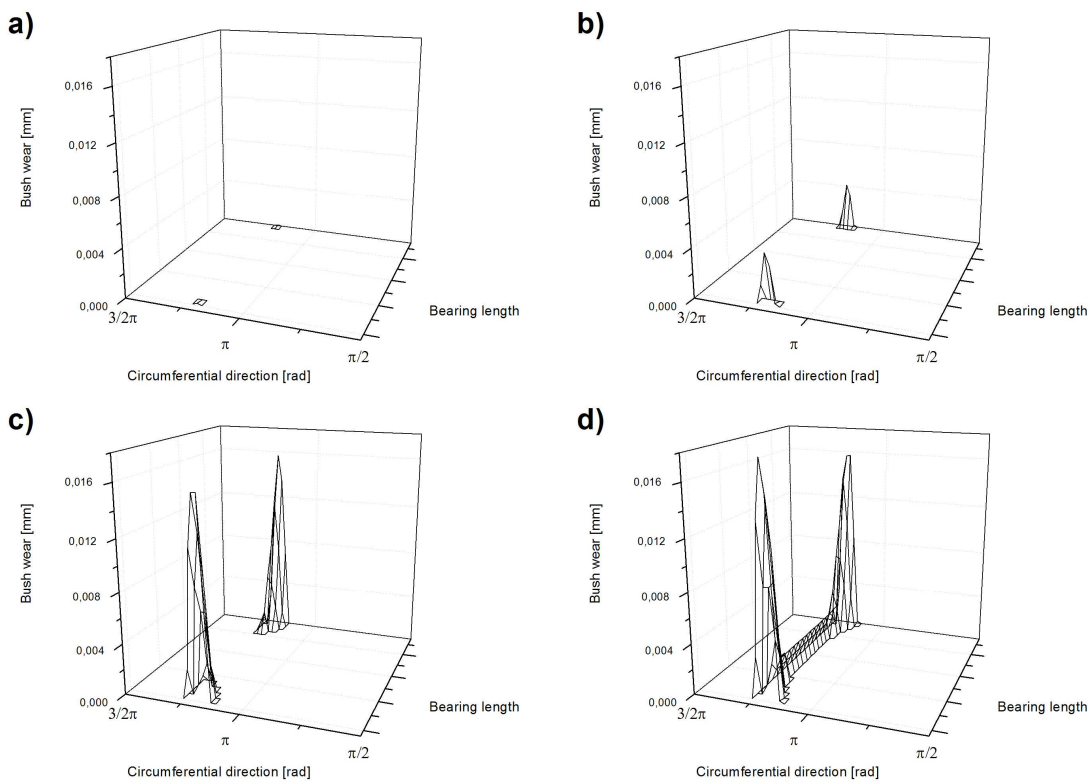

Fig. 6. Calculated bush wear zones in successive iterations conducted in accordance with EHL+LW method; a) iteration 1, b) iteration 8, c) iteration 16, d) iteration 17

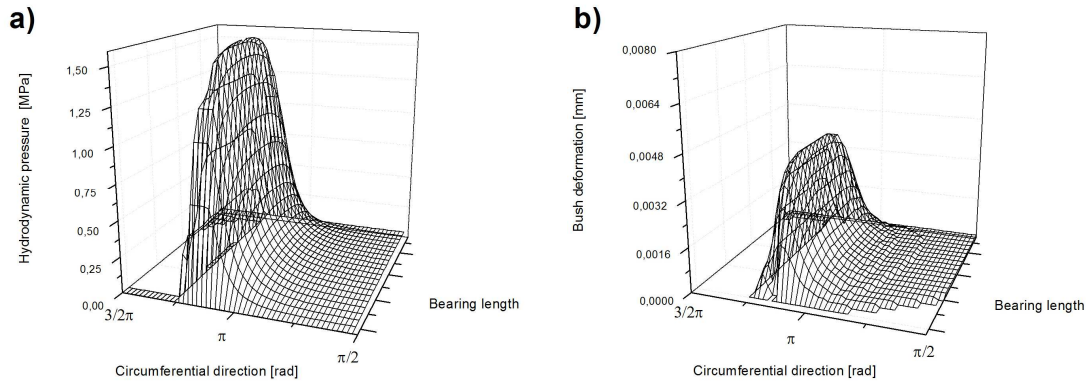

Fig. 7. Calculated hydrodynamic pressure in bearing inner space (a) PET elastic bush deformation using EHL+LW method; (b) PET elastic bush using EHL method; journal diameter 100mm, bearing clearance 0.4 mm, bearing load-carrying capacity app. 5.5 kN

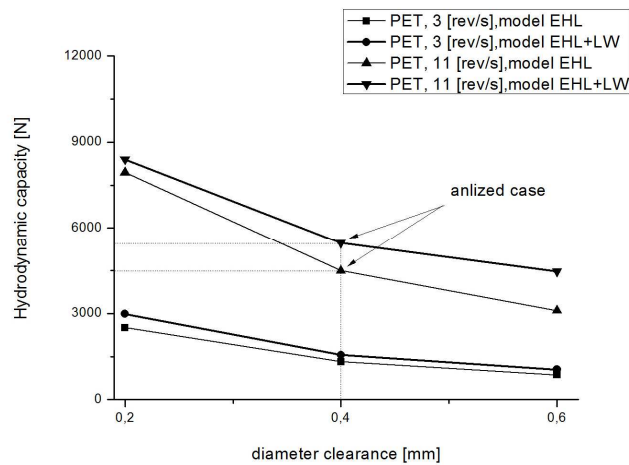

Fig. 8. Load-carrying capacity of the analyzed sliding bearing with PET bush, calculated using EHL and EHL+LW methods, as function of diameter clearance for two shaft journal speeds of 3 and 11 rev/s

5. Discussion

Water lubricated bearings are highly sensitive elements. Such bearings working at substantial loads under liquid lubrication regime, where the lubricating film thickness reaches a few micrometers are very susceptible to journal and bush misalignment. One might risk stating that in real machinery, such as water turbines or marine propulsion systems certain degree of misalignment is always present. Therefore, the character of bush material is of great consequence. When a rigid bush is used, e.g. made of sintered bronze, then stress concentration will occur at its edge, leading to intensive wear of the bush and the journal. More advantageous scenario occurs when the bush material is elastic. In such case, elastic bush deformation may take place. In the two situations above, for both bush types, the occurring misalignment leads to decrease of hydrodynamic load capacity of the bearing. Therefore, it may be deduced that in practice, some bearing systems work under a mixed friction regime. This has negative impact on the durability of such bearings.

It is worthwhile to take notice of the working characteristic of a water-lubricated bearing working under liquid lubrication regime. At the minimum lubricating film thickness (assumed at 6 μm),

the value of very elastic bush deformation (rubber or for some of polymers) may exceed it a number of times (in the analyzed case it was over 3 μm – Fig. 5b). In the author's opinion, using the proposed EHL+LW method which takes into account local bush wear, allows for more realistic modeling of the complex phenomena occurring in the sliding combination when the friction pair is separated by a very thin lubricating film.

Nevertheless, there is no doubt that the case where bush wear occurs simultaneously with journal and bush misalignment should be investigated further. In fact, it is the subject of currently conducted research work.

6. Conclusions

The completed research allows for gaining a better understanding of the complex phenomena which occur in water-lubricated bearings.

The experiments which were carried out proved that the water-lubricated sliding bearing has significantly greater hydrodynamic-load capacity than indicated by calculations executed using the EHL method. Taking into the account local bush wear, demonstrates that the bearing, despite periodic local contact between the bush and journal, will continue to work under fluid lubrication regime and its load-capacity will increase as a result of the bush edge shape modifications caused by local wear.

The issue of sliding surface smoothness should not be ignored. Although, generally speaking, it can be stated that in case of water-lubricated plastic bush bearings, the wear-in process takes place rather quickly.

In analyzing the obtained results, there appears a question regarding the impact of even slight axial misalignment of bush and journal, as well as that of developing bush wear process on the bearing's load capacity.

References

- [1] R. Orndorff, "Water lubricated rubber bearings, history and new developments," *Nav Eng J*, pp. 39–52, 1985.
- [2] R. Orndorff, L. Foster, and R. Sheppert, "From Lab to Field: New High Performance Water Lubricated Bearings," *World Tribol. Congr. II*, pp. 1–2, 2005.
- [3] H. Qin, X. Zhou, X. Zhao, J. Xing, and Z. Yan, "A new rubber/UHMWPE alloy for water-lubricated stern bearings," *Wear*, vol. 328–329, pp. 257–261, 2015.
- [4] Y. Zhimin, Z. Xincong, Q. Hongling, N. Wanying, W. Hao, L. Kai, and T. Yumin, "Study on tribological and vibration performance of a new UHMWPE/graphite/NBR water lubricated bearing material," *Wear*, vol. 332–333, pp. 872–878, 2015.
- [5] K. Laskey, "The non-metallic bearing – what you need to know," *World Pumps*, no. August, pp.

- 36–38, 2006.
- [6] K. Laskey and T. Bearings, “Nonmetallic Pump Bearings,” *PUMPS Syst.*, no. May, pp. 32–34, 2008.
- [7] M. Wodtke and M. Wasilczuk, “Evaluation of apparent Young’s modulus of the composite polymer layers used as sliding surfaces in hydrodynamic thrust bearings,” *Tribol. Int.*, vol. 97, pp. 244–252, 2016.
- [8] S. Yamajo and F. Kikkawa, “Development and Application of PTFE Compound Bearings,” *Dyn. Position. Conf.*, 2004.
- [9] W. Litwin and C. Dymarski, “Experimental research on water-lubricated marine stern tube bearings in conditions of improper lubrication and cooling causing rapid bush wear,” *Tribol. Int.*, vol. 95, pp. 449–455, 2016.
- [10] A. Ford, “New Composite seal and bearing technology for better performance,” *Wartsila Technical Journal*. pp. 34–39, 2012.
- [11] P. Hryniewicz, M. Wodtke, A. Olszewski, and R. Rzakowski, “Structural Properties of Foil Bearings: A Closed-Form Solution Validated with Finite Element Analysis,” *Tribol. Trans.*, vol. 52, no. 4, pp. 435–446, 2009.
- [12] W. Litwin and A. Olszewski, “Assessment of possible application of water-lubricated sintered brass slide bearing for marine propeller shaft,” *Polish Marit. Res.*, vol. 19, no. 76, pp. 54–61, 2012.
- [13] J. I. Lubinski, K. Druet, A. Olszewski, A. Neyman, and J. Sikora, “A MULTI RIG SCREENING TEST FOR THIN CERAMIC COATINGS IN BIO – TRIBOLOGICAL APPLICATIONS,” pp. 1–6.
- [14] X. Zhang, Z. Yin, D. Jiang, G. Gao, Y. Wang, and X. Wang, “Load carrying capacity of misaligned hydrodynamic water-lubricated plain journal bearings with rigid bush materials,” *Tribol. Int.*, 2016.
- [15] S. M. Chun and M. M. Khonsari, “Wear simulation for the journal bearings operating under aligned shaft and steady load during start-up and coast-down conditions,” *Tribol. Int.*, vol. 97, pp. 440–466, 2016.
- [16] G. Gengyuan, Y. Zhongwei, J. Dan, and Z. Xiuli, “CFD analysis of load-carrying capacity of hydrodynamic lubrication on a water-lubricated journal bearing,” *Ind. Lubr. Tribol.*, vol. 67, no. 1, pp. 30–37, 2015.
- [17] G. Gao, Z. Yin, D. Jiang, and X. Zhang, “Numerical analysis of plain journal bearing under hydrodynamic lubrication by water,” *Tribol. Int.*, vol. 75, pp. 31–38, 2014.
- [18] W. Litwin, “Influence of main design parameters of ship propeller shaft water-lubricated bearings on their properties,” *Polish Marit. Res.*, vol. 17, no. 4, pp. 39–45, 2011.
- [19] W. Litwin, “Water-lubricated bearings of ship propeller shafts - problems, experimental tests

- and theoretical investigations," *Polish Marit. Res.*, vol. 16, no. 4, pp. 41–49, 2010.
- [20] P. M. Lugt and G. E. Morales-Espejel, "A Review of Elasto-Hydrodynamic Lubrication Theory," *Tribol. Trans.*, vol. 54, no. 3, pp. 470–496, 2011.
- [21] R. Prehn, F. Hauptert, and K. Friedrich, "Sliding wear performance of polymer composites under abrasive and water lubricated conditions for pump applications," *Wear*, vol. 259, no. 1–6, pp. 693–696, 2005.
- [22] S. Meicke and R. Paasch, "Seawater lubricated polymer journal bearings for use in wave energy converters," *Renew. Energy*, vol. 39, no. 1, pp. 463–470, 2012.
- [23] Y. Yamamoto and M. Hashimoto, "Friction and wear of water lubricated PEEK and PPS sliding contacts Part 2. Composites with carbon or glass fibre," *Wear*, vol. 257, no. 1–2, pp. 181–189, 2004.
- [24] M. Masjedi and M. M. Khonsari, "An engineering approach for rapid evaluation of traction coefficient and wear in mixed EHL," *Tribol. Int.*, vol. 92, pp. 184–190, 2015.