

## Hocine TILIOUINE

GDAŃSK UNIVERSITY OF TECHNOLOGY, FACULTY OF ELECTRICAL AND CONTROL ENGINEERING,  
DEPARTMENT OF THEORETICAL ELECTROTECHNICS AND INFORMATICS  
ul. G. Narutowicza 11/12, 80-233 Gdańsk

# Intelligent Turbogenerator Controller Based On Artificial Neural Network

Ph.D. HOCINE TILIOUINE

He was graduated in electrical engineering in 1977 from Ecole Nationale Polytechnique d'Alger and got PhD degree in electrical power system in 1986 from Gdansk University of Technology. He worked for the Algerian National Electric and Gas Company and for Tizi-Ouzou University of Technology (Algeria). In June 1992 he joined the Faculty of Electrical and Control Engineering - Gdansk University of Technology. His current research interests are in power system control and stability and the artificial intelligence based techniques for excitation.



e-mail: h.tiliouine@ehy.pg.gda.pl

### Abstract

The paper presents a design of an intelligent controller based on neural network (ICNN). The ICNN ensures at the same time two fundamental functions: the maintaining of generator voltage at the desired value and the damping of the electromechanical oscillations. Its performance is evaluated on a single machine infinite bus power system through computer simulations. The dynamic and transient operation of the proposed controller is compared with the operation of the conventional excitation control system composed of a conventional automatic voltage regulator (CAVR) and a conventional power system stabilizer (CPSS) as recommended in the IEEE standard. The proposed ICNN exhibits better performance.

**Keywords:** neural network, voltage controller, power system stabilizer, turbogenerator.

## Inteligentny regulator turbogenerators oparty na sieci neuronowej

### Streszczenie

W artykule przedstawiono projekt inteligentnego regulatora opartego na sieci neuronowej, przeznaczonego do sterowania generatorem synchronicznym pracującym w systemie elektroenergetycznym. Proponowany regulator realizuje jednocześnie dwie podstawowe funkcje: utrzymanie napięcia generatora na zadanej wartości oraz tłumienie kołysań elektromechanicznych. Regulator zbudowany jest w oparciu o dwie sieci neuronowe: Emulator (lub Identyfikator) i właściwy regulator. Emulator wykorzystywany jest do predykcji parametrów wyjściowych generatora (napięcie, moc), a regulator minimalizuje zadaną funkcję celu. Efektywność regulatora została oceniona na podstawie badań symulacyjnych w układzie jednomaszynowym pracującym w systemie elektroenergetycznym. Dynamiczne działanie proponowanego regulatora porównano z dynamicznym działaniem klasycznego układu regulacji, składającego się z konwencjonalnego regulatora napięcia i konwencjonalnego stabilizatora systemowego - zgodnie z zaleceniami standardu IEEE. Na podstawie tego porównania stwierdzono, że proponowany regulator jest bardziej efektywny. Zapewnia duże tłumienie kołysań elektromechanicznych jednocześnie przy zapewnieniu szybkiej regulacji napięcia generatora. Dodatkowo ten regulator charakteryzuje się prostą strukturą.

**Słowa kluczowe:** sieci neuronowe, regulator napięcia, stabilizator systemowy, turbogenerator.

## 1. Introduction

In an electric power system, the excitation system contributes in an effective voltage control and enhancement of the system stability. It must be able to respond quickly to a disturbance enhancing the transient stability and the small signal stability. The objective of the control strategy is to generate and deliver power in an interconnected system as economically and reliably as possible while maintaining the voltage and frequency within permissible limits.

The growth in size and complexity of electric power systems along with increase in power demand have led to a surge in the development of new control strategies. Controlling such complex systems highly non-linear has shown to be very difficult using conventional control theory. Conventional control systems are unable to maintain their performance under constantly changing operating conditions. In these cases the artificial intelligence with its natural language has proven to be useful.

In the last two decades there has been substantial interest in the application of artificial neural networks (ANN) in the identification and control of unknown nonlinear dynamical plants [1-9]. Several reasons have motivated vast research interests in the application of neural networks for control purposes, as alternative to traditional control methods, among which the main points are:

- Using the neural networks we can avoid the use of complex and difficult mathematical analyses, which is dominant in many traditional adaptive and optimal control methods.
- The inclusion of nonlinear activation function in the neurons of multi-layered neural networks offers nonlinear mapping ability for solving highly nonlinear control problems where traditional control approaches have no practical solution yet. Perhaps, this is the most significant advantage of using neural networks from the control theoretical viewpoint.

In the field of voltage control of synchronous generators connected to the power system much work has been done [1, 3, 4, 6, 7, 9]. In some of these works [1, 3, 4, 6] the architecture of the controller is quite complex. For example in [1] the controller is composed of two separate neural networks, each with its function: one as a voltage regulator and the other as a power system stabilizer. In this paper the proposed controller configuration is much simple: only one network with the task of ensuring both mentioned functions is needed.

## 2. Power system model

The single machine infinite bus power system model used to evaluate the proposed control scheme is shown in Fig. 1. It consists of a synchronous generator, a static controlled exciter, a three-stage turbine, and a governor system. The generator is connected to an infinite bus system through a step-up transformer and parallel transmission lines.

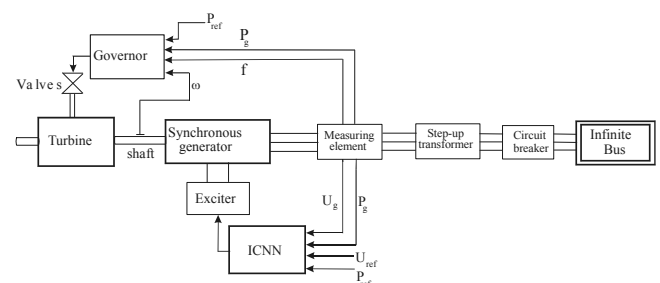

Fig. 1. Power system model configuration

Rys.1. Schemat badanego systemu

The synchronous generator is described by a seven-order d-q axis set of differential equations. The conventional automatic voltage regulator (CAVR) with a static exciter and the conventional power system stabilizer (CPSS) used in the simulation study are from IEEE Standard [10].

The set of generator equations, the block diagrams of the conventional excitation control elements, and the parameters used in the study, are given in the Appendix.

### 3. Design of the proposed neuro-control scheme

The proposed neuro-control scheme consists of two separate neural networks (Fig. 2), namely the neuro-estimator (NE) and the intelligent controller based on neural network (ICNN). The NE identifies the plant to be controlled, and the ICNN generates the control action to drive the process to desired set point.

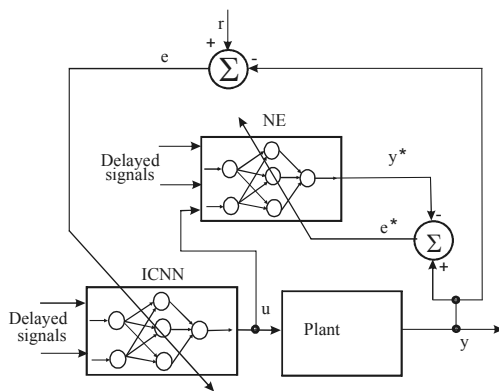

Fig. 2. Structure of the proposed neuro-control scheme  
Rys. 2. Struktura proponowanego neuronowego układu sterowania

#### 3.1. Neuro-estimator (NE)

The NE (Fig. 3) is a two-layered neural network, whose input consists of delayed signals: the voltage deviation  $\Delta U_g$  of generator terminals, the active power deviation  $\Delta P_g$  of generator and the output signal  $U_c$  of the neuro-controller.

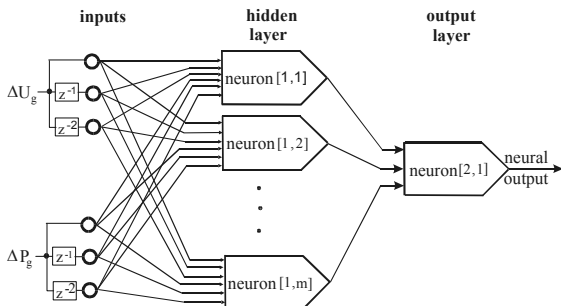

Fig. 3. Internal structure of the neuro-estimator  
Rys. 3. Wewnętrzna struktura neuro-estymatora

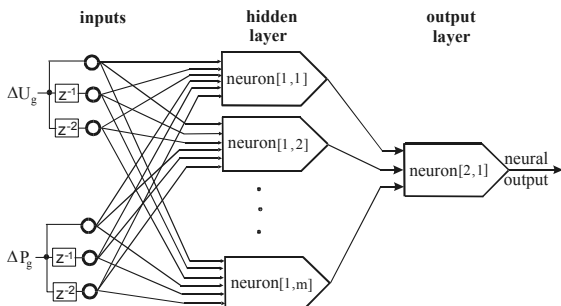

Fig. 4. Internal structure of the intelligent controller based on neural network  
Rys. 4. Wewnętrzna struktura inteligentnego regulatora w oparciu o sieci neuronowe

The hidden layer consists of twelve nonlinear neural units, the output layer of two nonlinear neural units. The two output signals are the predicted value  $U_g^*$  of generator voltage and the predicted value  $P_g^*$  of generator active power.

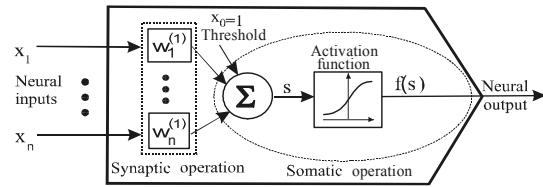

Fig. 5. Block diagram representation of a nonlinear neural unit [11]  
Rys. 5. Schemat blokowy pojedynczego nieliniowego neuronu [11]

#### 3.2. Intelligent controller based on neural network (ICNN)

The ICNN is also a two-layered neural network with six inputs, a single hidden layer with nine neurons, and one output. The input signals are the delayed signals of  $\Delta U_g$  and  $\Delta P_g$ .

Each of neural units used in the subnetworks NE and ICNN is nonlinear and has the structure given in Fig. 5. The activation function associated to each of them is the sigmoidal function

$$f(net_j) = \frac{1}{1 + e^{-net_j}}, \quad (1)$$

$$net_j = \sum_{i=1} w_{ji} x_i + x_0, \quad (2)$$

where  $net_j$  is the input to a neuron  $j$ ,  $x_0$  is a threshold value,  $w_{ji}$  is the connection weight from neuron  $i$  to a neuron  $j$ ,  $x_i$  is an output signal of a neuron  $i$ .

#### 3.3. Training process

The training of the NE is realized by adapting the connection weights such the following error function is minimized,

$$E = \frac{1}{2} (U_g - U_g^*)^2 + \frac{1}{2} (P_g - P_g^*)^2, \quad (3)$$

where  $U_g^*$ ,  $P_g^*$  represent the predicted values respectively of the terminal voltage and the active power.

Whereas, for the training of the controller ICNN the error function to minimize is:

$$E = \frac{1}{2} k_u (U_{ref} - U_g)^2 + \frac{1}{2} k_p (P_{ref} - P_g)^2, \quad (4)$$

where  $U_{ref}$ ,  $P_{ref}$  are respectively the reference voltage and the reference active power of the synchronous generator. The parameters  $k_u$  and  $k_p$  are constant and  $k_u + k_p = 1$ .

Within each interval time  $[k, k+1]$  the backpropagation (BP) algorithm is employed to update the connection weights of the subnetworks NE and ICNN. According to the BP method the change to be made to connection weight  $w_{ij}$  at each interval time is [12, 13, 14]:

$$\Delta w_{ij} = - \frac{\partial E}{\partial w_{ij}}, \quad (5)$$

At time  $[k+1]$  the connection weight  $w_{ij}$  is calculated using the relation:

$$w_{ij}(k+1) = w_{ij}(k) - \eta \frac{\partial E}{\partial w_{ij}}, \quad (6)$$

where  $\eta$  is the learning rate.

#### 4. Simulation tests

A number of simulation tests for a variety of operating conditions and disturbances have been made using separately the following excitation control systems:

- the proposed neuro-control system;
- the IEEE recommended excitation control system given in the Appendix.

In this paper only a representative set of realized investigations is presented. These investigations are as follows:

a – With the system operating initially at 0.85 p.u. of active power and -0.53 p.u. of reactive power the following disturbances were applied separately:

- a 5% p.u. step change in the reference voltage was applied at time 0 s and removed at time 5 s;
- a three-phase short-circuit at the infinite bus was applied at time 0 s and cleared 150 ms later;
- a 5% p.u. step change in reference power was applied at time 0 s and removed at 20 s later.

b – The dynamic and transient behavior of the generating unit has been also tested under the same disturbances as above, but this time with the synchronous generator operating at  $P_g=0.80$  p.u. and  $Q_g=0.20$  p.u.

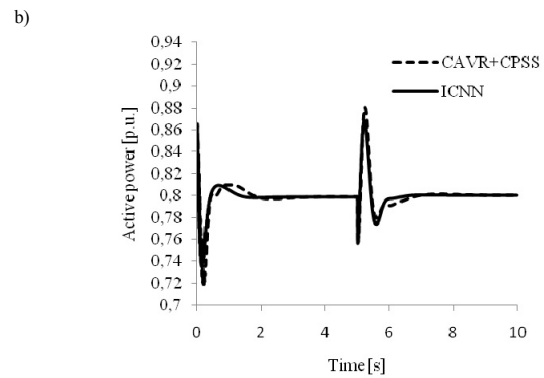
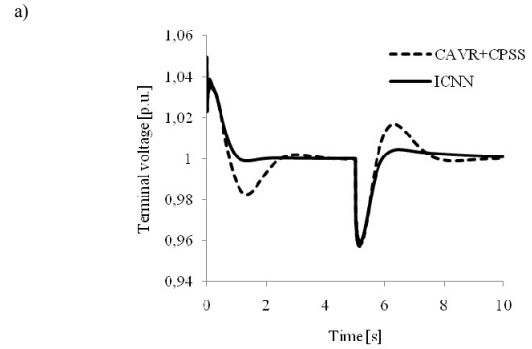

Fig. 7. System responses to a step change in reference voltage  $P_g=0.80$  p.u.,  $Q_g=0.20$  p.u.

Rys. 7. Odpowiedzi systemu na skokową zmianę wartości zadanego napięcia  $P_g = 0.80$  p.u.,  $Q_g = 0.20$  p.u.

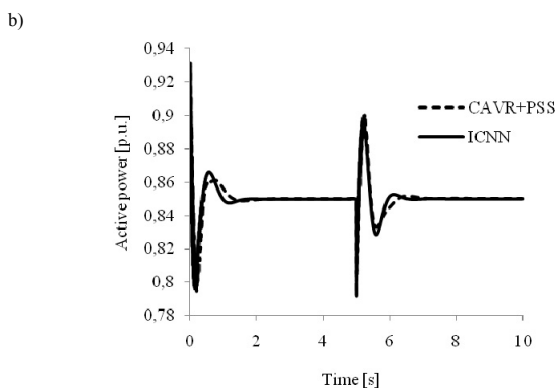
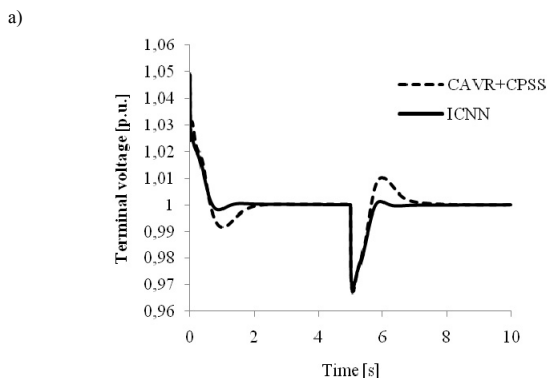

Fig. 6. System responses to a step change in reference voltage  $P_g=0.85$  p.u.,  $Q_g=-0.53$  p.u.

Rys. 6. Odpowiedzi systemu na skokową zmianę wartości zadanego napięcia  $P_g = 0.85$  p.u.,  $Q_g = -0.53$  p.u.

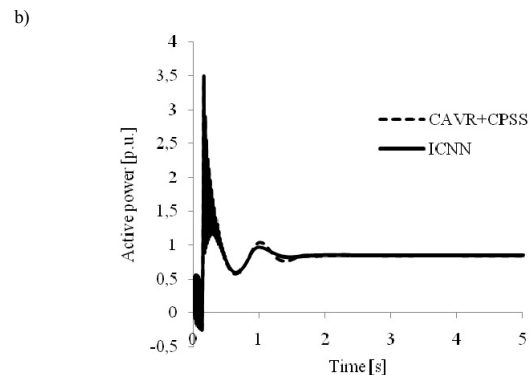
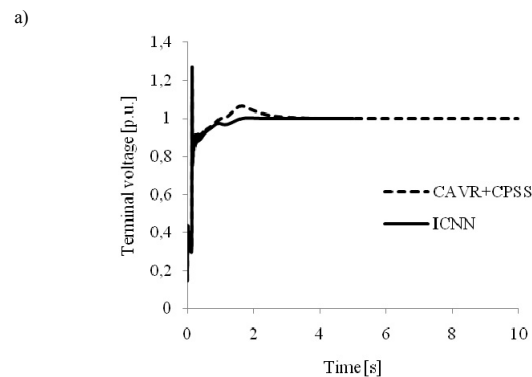

Fig. 8. System responses to a three-phase short circuit  $P_g=0.85$  p.u.,  $Q_g=-0.53$  p.u.

Rys. 8. Odpowiedzi systemu na symetryczne trójfazowe zwarcie  $P_g = 0.85$  p.u.,  $Q_g = -0.53$  p.u.



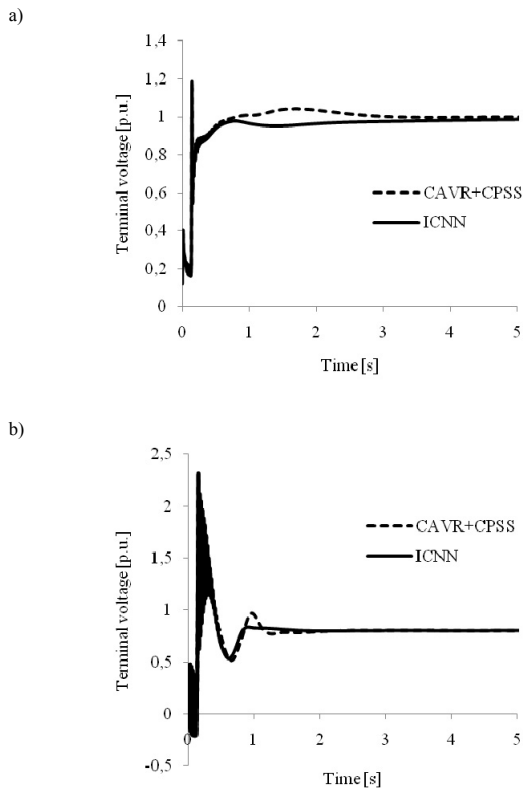

Fig. 9. System responses to a three-phase short circuit

$$P_g = 0.80 \text{ p.u.}, Q_g = -0.20 \text{ p.u.}$$

Rys. 9. Odpowiedzi systemu na symetryczne trójfazowe zwarcie

$$P_g = 0.80 \text{ p.u.}, Q_g = -0.20 \text{ p.u.}$$

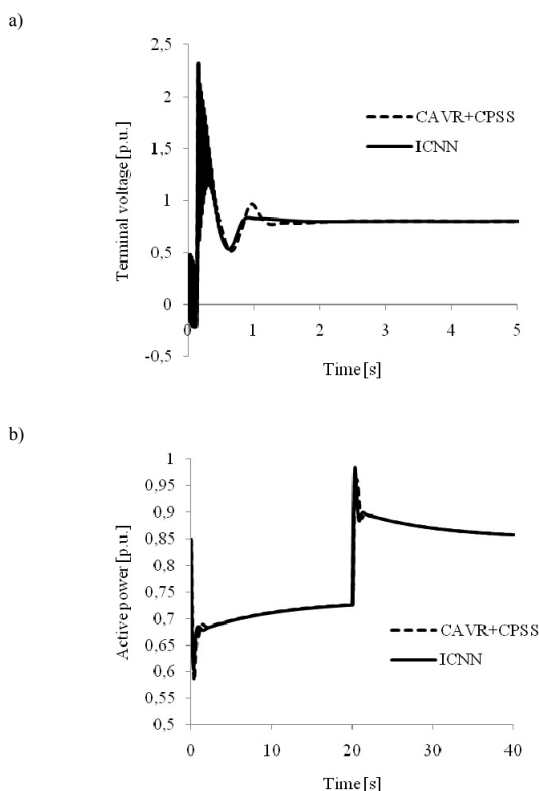

Fig. 10. System responses to a step change in the reference active power

$$P_g = 0.85 \text{ p.u.}, Q_g = -0.53 \text{ p.u.}$$

Rys. 10. Odpowiedzi systemu na skokową zmianę wartości zadanej mocy

$$P_g = 0.85 \text{ p.u.}, Q_g = -0.53 \text{ p.u.}$$

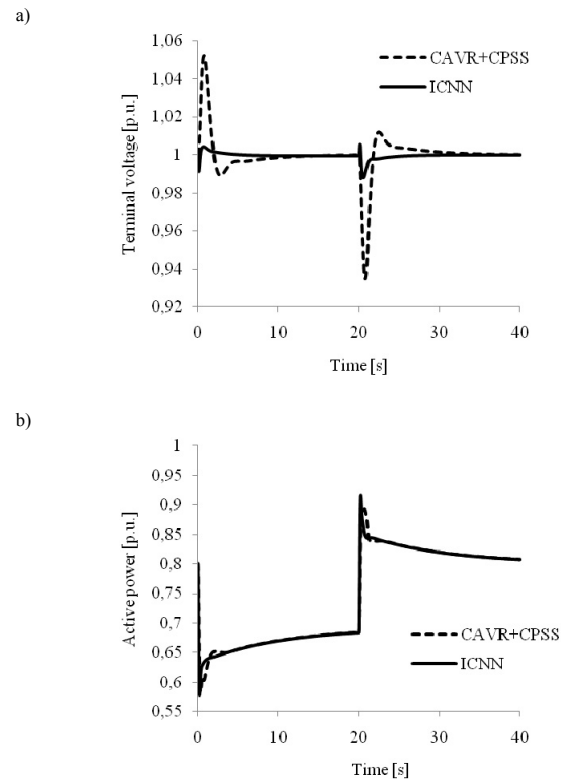

Fig. 11. System responses to a step change in the reference active power

$$P_g = 0.80 \text{ p.u.}, Q_g = 0.20 \text{ p.u.}$$

Rys. 11. Odpowiedzi systemu na skokową zmianę wartości zadanej mocy

$$P_g = 0.80 \text{ p.u.}, Q_g = 0.20 \text{ p.u.}$$

The simulation results obtained with both excitation control systems are illustrated and compared in Figures 6÷11.

All figures contain the terminal voltage response and the active power response of the synchronous generator. The Figures 6a, 7a, 10a and 11a show that the terminal voltage response is much better with the Intelligent Controller based on Neural Network (ICNN) than with the Conventional Automatic Voltage Regulator (CAVR) equipped with conventional power system stabilizer (CPSS). The damping of the electromechanical oscillations (Figures 6b, 7b, 8b, 9b, 10b, 11b) is high with both excitation control systems.

## 5. Conclusions

An intelligent controller based on neural network (ICNN) for a single machine infinite bus power system was presented in this paper. The ICNN ensures both a good voltage regulation and a good electromechanical oscillations damping. Its architecture is very simple compared to those presented in some scientific articles.

To evaluate the proposed ICNN the simulation tests under different kinds of disturbances and operating conditions have been made. The obtained results are compared with those given by the IEEE recommended conventional AVR-PSS. The comparison of these results shows that the proposed ICNN exhibits better performance than the conventional AVR-PSS.

## 6. Appendix

### A.1. Differential equations used in the model of the investigated generating unit

$$\frac{1}{\omega_s} \frac{d\psi_d}{dt} = -u_d - \omega\psi_q - r_s i_d$$

$$\frac{1}{\omega_s} \frac{d\psi_q}{dt} = -u_q + \omega\psi_d - r_s i_q$$

$$\frac{1}{\omega_s} \frac{d\psi_f}{dt} = u_f - r_f i_f$$

$$\frac{1}{\omega_s} \frac{d\psi_{kd}}{dt} = -r_{kd} i_{kd}$$

$$\frac{1}{\omega_s} \frac{d\psi_{kq}}{dt} = -r_{kq} i_{kq}$$

$$\frac{1}{\omega_s} \frac{d\delta}{dt} = \omega - 1$$

$$\frac{d\omega}{dt} = \frac{1}{2H} (T_m - T_e)$$

#### A.2. Used values of the above constant parameters

$$\omega_s = 100\pi \text{ s}^{-1}; H = 3.72 \text{ s}; r_s = 0.0023 \text{ p.u.}; r_f = 0.00093 \text{ p.u.};$$

$$r_{kd} = 0.01365 \text{ p.u.}; r_{kq} = 0.02440 \text{ p.u.}$$

#### A.3. Bloc diagram of the IEEE recommended conventional power system stabilizer (PSS1A)

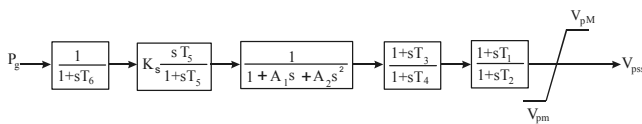

Fig. A.1. Block diagram of the conventional PSS1A [10]

Rys. A.1. Schemat blokowy konwencjonalnego stabilizatora systemowego PSS1A [10]

#### A.4. Parameters of the conventional PSS

$$T_1 = 0.166 \text{ s}; T_2 = 0.039 \text{ s}; T_3 = 0.139 \text{ s}; T_4 = 0.659 \text{ s};$$

$$T_5 = 1.012 \text{ s}; T_6 = 0.041 \text{ s};$$

$$K_{pss} = 18.72; A_1 = 0; A_2 = 0; V_{pssMin} = -0.47;$$

$$V_{pssMax} = 0.51.$$

#### A.5. Nomenclature

$\psi_d, \psi_q$  flux linkage in d q axis

$\psi_f$  field flux linkage

$\psi_{kd}, \psi_{kq}$  damping flux linkage in d q axis

$i_d, i_q$  generator current in d q axis

$u_d, u_q$  generator voltage in d q axis

$u_f$  field voltage

$i_{kd}, i_{kq}$  damping currents in d q axis

$r_{kd}, r_{kq}$  damping windings resistance i d q axis

$\omega$  electrical generator speed

$\omega_s$  synchronous generator speed in [ $\text{s}^{-1}$ ]

## 7. References

- [1] Lubośny Z.: Adaptacyjny neuronowy regulator generatora synchronicznego. Przegląd Elektrotechniczny, R.80, nr 10, s. 971-974, 2004.
- [2] Min Han, Wei Guo, Jincheng Wang: Predictive control based on feedforward neural network for strong nonlinear system. Neural Networks, 2005. IJCNN '05. Proceedings. 2005 IEEE Int. Joint Conference, Vol. 4, pp. 2266 – 2271, 2005.
- [3] Dingguo Chen, Mike York: Adaptive Neural Inverse Control Applied to Power. Power Systems Conference and Exposition, 2006. PSCE '06. 2006 IEEE PES, pp. 2109 – 2115, 2006.
- [4] Venayagamoorthy, G.K., Harley, R.G.: Intelligent optimal control of excitation and turbine systems in power networks. Power Engineering Society General Meeting, pp. 1 – 8, 2006. IEEE.
- [5] Ming-guang Zhang, Ming-hui Qiang: Study of PID Neural Network Control for Nonlinear System. Signal Processing, 2006 8th Int. Conference on, Vol. 3, pp. 1-4, 2006.
- [6] Tiliouine H.: Adaptive neural voltage controller with tunable activation gain. Pomiary Automatyka Kontrola, vol. 53, No 54, s. 114-116, 2007.
- [7] Tiliouine H.: A modified neural network controller configuration, 14th Int. Conference on Methods and Models in Automation and Robotics, Międzyzdroje, Poland, Vol.14, part I, August 2009.
- [8] Chengli Su, Yun Wu: Adaptive neural network predictive control based on PSO algorithm. Control and Decision Conference, 2009. CCDC '09. Chinese, pp. 5829 - 5833, 2009.
- [9] Liao Zhong: The Application of Wavelet Neural Network in Adaptive Inverse Control of Hydro-turbine Governing System. Artificial Intelligence and Computational Intelligence. AICI '09. Int. Conference, Vol. 2, pp. 163 – 166, 2009.
- [10] IEEE Recommended practice for excitation system models for power system stability studies. IEEE Std 421.5-2005 (Revision of IEEE Std 421.5-1992), pp. 1 – 85, 2006.
- [11] Gupta M.M, Liang J., Noriyasu H.: Static and dynamic neural networks. A John Wiley & Sons, Inc., 2003.
- [12] Tadeusiewicz R.: Sieci Neuronowe. Akademicka Oficyna Wydawnicza RM, Warszawa 1993.
- [13] Korbicz J., Obuchowicz A., Uciński D.: Sztuczne Sieci Neuronowe. Podstawy i Zastosowania. Akademicka Oficyna Wydawnicza PLJ, Warszawa 1994.
- [14] Rutkowska D., Piliński M., Rutkowski L.: Sieci Neuronowe. Algorytmy Genetyczne i Systemy Rozmyte. Wydawnictwo Naukowe PWN, Warszawa – Łódź 1997.

otrzymano / received: 29.11.2010

przyjęto do druku / accepted: 02.02.2010

artykuł recenzowany

## INFORMACJE

# Wersja elektroniczna miesięcznika PAK

## Pomiary Automatyka Kontrola – Measurement Automation and Monitoring

Artykuły opublikowane w PAK po roku 1989 są dostępne w wersji elektronicznej m.in. w bazie artykułów PAK (www.pak.info.pl), w folderze „Archiwum numerów miesięcznika PAK”:

- pełne teksty artykułów starszych niż 3 lata oraz streszczenia artykułów najnowszych można pobrać bezpłatnie,
- pełne teksty artykułów najnowszych można otrzymać za opłatą (5 PLN +1,15 PLN VAT).

