

INVESTIGATION OF THE EFFICIENCY OF A DUAL-FUEL GAS TURBINE COMBUSTION CHAMBER WITH A PLASMA-CHEMICAL ELEMENT

Serhiy Serbin  ^{1*}

Badri Diasamidze  ¹

Marek Dzida  ²

Daifen Chen ³

¹ Admiral Makarov National University of Shipbuilding, Mikolayiv, Ukraine

² Gdansk University of Technology, Poland

³ Jiangsu University of Science and Technology, Zhenjiang, China

* Corresponding author: serbin1958@gmail.com (Serhiy Serbin)

ABSTRACT

The study is devoted to the possibility of increasing the efficiency of the working process in dual-fuel combustion chambers of gas turbine engines for FPSO vessels. For the first time, it is proposed to use the advantages of plasma-chemical intensification of the combustion of hydrocarbon fuels in the dual-fuel combustion chambers, which can simultaneously operate on gaseous and liquid fuels. A design scheme of a combustion chamber with a plasma-chemical element is proposed. A continuous type mathematical model of a combustion chamber with a plasma-chemical element has been developed, which is based on the solution of a system of differential equations describing the processes of chemical reactions in a turbulent system, taking into consideration the initiating effect of the products of plasma-chemical reactions on the processes of flame propagation. A modified six-stage kinetic scheme of hydrocarbon oxidation was used to simultaneously predict the combustion characteristics of the gaseous and liquid fuels, taking into account the decrease in the activation energy of carbon monoxide oxidation reactions when the products of the plasma-chemical element are added. The results reveal that the addition of plasma-chemical products significantly reduces CO emissions in the outlet section of the flame tube (from 25–28 ppm to 3.9–4.6 ppm), while the emission of nitrogen oxides remains practically unchanged for the studied combustion chamber. Further research directions are proposed to enhance the working process efficiency of a dual-fuel combustion chamber for gas turbine engines as part of the power plant of FPSO vessels.

Keywords: gas turbine engine; power plant; dual-fuel combustion; combustion chamber; liquid and gaseous fuels, plasma-assisted combustion

INTRODUCTION

Contemporary challenges have led to increased research and development of marine infrastructure, particularly related to FPSO vessels [1–3]. The use of gas turbine engines on such vessels [4–6] has emerged as a promising approach to improving their technical and economic performance. Previous studies [7–8] have shown that the simultaneous operation of gas turbine engines with fuels differing in phase state is possible, and the problems arising during the simultaneous

operation of low-emission gas turbine combustion chambers on different fuels have been identified. To address these problems, the plasma-chemical method of combustion intensification [9–10] offers a promising way to improve the efficiency of using various hydrocarbon fuels. Several studies [11–12] have shown the benefits of this approach, including an extended range of stable operation, increased completeness of fuel combustion, reduced non-uniformity of temperature fields at the outlet of the combustion chamber, and reduced emissions of toxic components [13–14].

The method of plasma-chemical burning of fuels in the combustion chambers of heat engines [15–17] is implemented by systems containing low-temperature plasma generators (plasma torches), power sources, devices for supplying plasma gas, fuel, means of regulating and controlling parameters and operating modes. The key elements of the systems are plasma torches, or plasma-chemical elements developed on their basis, plasma-fuel nozzles, plasma-chemical generators of hydrogen-containing gas, and plasma igniters. Moreover, in [18], the results of research on plasma-fuel nozzles are presented, showing a significant reduction in nitrogen oxide emissions during the combustion of a fuel-air mixture in an experimental reverse-vortex combustion chamber, as well as the possibility of expanding the range of stable operation of the chamber as a result of plasma assistance.

The set of studies carried out in [19, 20] on increasing the efficiency of gas turbine engines made it possible to create systems of plasma-chemical ignition and combustion, which significantly increase the reliability of starting power plants, increase the completeness of combustion of hydrocarbon fuels, and also reduce the emission of carcinogenic substances. The plasma-chemical combustion intensification system is designed for flame stabilisation in devices for fuel burning (gaseous, liquid, alternative) and consists of a plasma-chemical element and its energy supply source. When fuel is fed into the plasma air jet, thermochemical reactions occur, which determine a significant yield of active components (radicals, atoms, intermediate compounds).

The completed works on the creation of plasma-chemical systems allowed us to carry out experimental and industrial testing of several systems of plasma-chemical combustion intensification for energy equipment. It was found that similar systems provide a 2–3 times expansion of the range of stable ignition and burning of fuel in the combustion chamber even when using liquid fuel, increase the stability of combustion in transient modes, increase the completeness of combustion during the start-up process, improve the flame propagation conditions, increase the reliability of operation, and prevent combustion chamber extinction during operation [10, 19].

The reactions that occur when mixing low-temperature air plasma with fuel in the volume of a plasma-chemical element or on the surface of a swirling plasma jet under certain conditions lead to the formation of over-equilibrium concentrations of atoms and radicals (H, CH₃, O, OH, etc.) and a large number of products of incomplete conversion of hydrocarbons (CO, H₂). Reaction products from the zone of direct contact of the plasma with part of the fuel quickly diffuse into the zone of the main fuel-air mixture and contribute to the intensification of its combustion.

The current level of development of low-current plasma generators of direct current (arc current less than 2 A) makes it possible to use their advantages (long service life of electrodes, no need for their water cooling, significant thermal efficiency, small dimensions, the possibility of working at high pressure) to increase the efficiency of dual-fuel combustion chambers.

An innovative approach to the implementation of reliable ignition of various fuels in any conditions, including starting at high pressures, smooth adjustment of the air excess coefficient, temperature, and thermal power, flameout prevention, the

use of gaseous and liquid fuels, including with high moisture content, allows plasma-chemical devices with low-current plasma generators to be considered as promising for dual-fuel combustion chambers of gas turbine engines.

Therefore, the purpose of the work is to increase the efficiency of a gas turbine dual-fuel combustion chamber, intended for operation as part of the power plant of an FPSO vessel, through the use of a plasma-chemical element.

MATHEMATICAL MODELLING

In recent years, several studies have investigated various aspects of the modelling and thermodynamic analysis of the effects of low-temperature plasma on combustion processes, specifically for gaseous fuels [21], liquid hydrocarbons [22], and coal [23]. However, these studies have primarily focused on fuel-burning devices operating on a single fuel type. To theoretically analyse the combustion processes of liquid and gaseous fuels and the effects of air plasma on the physicochemical mechanisms in dual-fuel gas turbine combustion chambers, a three-dimensional modelling method was employed. This method considered the mechanisms of plasma-chemical combustion intensification for hydrocarbon fuels that vary in physical state. A continuum-type mathematical model was developed, which describes the laws of mass, energy, momentum, and chemical component conservation and transfer in a chemically reacting turbulent two-phase system. It is worth noting that this model enables numerical experiments to be conducted with virtual models of fuel combustion devices and provides new insights into the structure of turbulent flows under non-isothermal conditions, turbulent pulsations, plasma activation, and complex geometric shapes of dual-fuel combustion chambers. For modelling of the physical and chemical processes inside the dual-fuel combustion chamber with plasma assistance, a generalised method based on a numerical solution of the combined conservation and transport equations for a multi-component chemically reactive turbulent system was employed [9–16]. This method provides a procedure for numerical integration of the differential equations, which describe the reacting viscous gas flows. A 3D model of the reacting flows has been used which enables the prediction of the plasma-chemical influence and optimisation parameters taking into consideration mixing, turbulence, radiation, and combustion features [24–26].

The mass conservation equation may be represented as follows:

$$\frac{\partial \rho}{\partial t} + \nabla(\rho \vec{v}) = S_m, \quad (1)$$

where ρ is the flow mass density, ρ is the local flow velocity vector, and S_m is the mass added to the continuous phase from the dispersed second phase.

The momentum conservation equation in a fixed system of reference may be formed as follows:

$$\frac{\partial}{\partial t} (\rho \vec{v}) + \nabla(\rho \vec{v} \vec{v}) = -\nabla p + \nabla \cdot (\tau_{st}) + \rho \vec{g} + \vec{F}, \quad (2)$$

where p is the static pressure, τ_{st} is the stress tensor, and $\rho \vec{g}$ and \vec{F} are the gravitational and external body forces, respectively.

For aerodynamic prediction, the RNG-based k-ε-turbulence model was used [27].

In a general form, the energy conservation equation is written as follows:

$$\frac{\partial}{\partial t} (\rho E) + \nabla \cdot (\vec{v} (\rho E + p)) = \nabla \cdot (k_{eff} \nabla T - \sum_j \vec{J}_j + (\vec{\tau}_{eff} \cdot \vec{v})) + S_h, \quad (3)$$

where E is the total energy, k_{eff} is the effective conductivity, \vec{J}_j is the diffusion flux of species j , and $\vec{\tau}_{eff}$ is the effective viscosity coefficient. The term S_h includes the heat of the chemical reaction inside the combustion chamber, and any other volumetric heat sources.

For the liquid fuel burning calculations in the dual-fuel combustion chamber, the coupled discrete phase model (DPM) was used. The Lagrangian discrete phase model [22, 28, 29] follows the Euler-Lagrange approach. The fluid phase is treated as a continuum by solving the time-averaged Navier-Stokes equations, while the dispersed phase is solved by tracking a large number of droplets through the calculated flow field. The coupling between the phases and their impact on both the discrete phase trajectories and the continuous phase flow has been included.

This force balance equates the particle inertia with the forces acting on the particle and can be written (for the direction in Cartesian coordinates) as

$$\frac{du_p}{dt} = F_D(u - u_p) + \frac{g_x(\rho_p - \rho)}{\rho_p} + F_x, \quad (4)$$

where F_x is the additional acceleration term, $F_D(u - u_p)$ is the drag force per unit particle mass, and

$$F_D = \frac{18\mu C_D Re}{\rho_p d_p^2 24}.$$

Here, u is the fluid phase velocity, u_p is the particle velocity, μ is the molecular viscosity of the fluid, ρ is the fluid density, ρ_p is the density of the particle, d_p is the particle diameter, and Re is the relative Reynolds number.

The inert heating model is applied when a particle temperature is less than the vaporisation temperature and after the volatile fraction of the particle has been consumed. This procedure uses a simple heat balance to relate the particle temperature to the convective heat transfer and the absorption/emission of radiation at the particle surface:

$$m_p c_p \frac{dT_p}{dt} = h A_p (T_\infty - T_p) + \varepsilon_p A_p \sigma (\theta_R^4 - T_p^4), \quad (5)$$

where m_p is the mass of the particle, c_p is the heat capacity of the particle, A_p is the surface area of the particle, T_∞ is the local temperature of the continuous phase h is the convective heat transfer coefficient, ε_p is the particle emissivity, σ is the Stefan-Boltzmann constant, and θ_R is the radiation temperature.

The droplet vaporisation model is initiated when the temperature of the droplet reaches the vaporisation temperature and continues until the droplet reaches the boiling point T_{bp} .

Heat transfer to the particle during the vaporisation process includes contributions from convection, radiation, and the heat value consumed during vaporisation:

$$m_p c_p \frac{dT_p}{dt} = h A_p (T_\infty - T_p) + \frac{dm_p}{dt} h_{fg} + \varepsilon_p A_p \sigma (\theta_R^4 - T_p^4), \quad (6)$$

where h_{fg} is the latent heat.

The mass of the droplet is reduced according to the equation

$$m_p(t + \Delta t) = m_p(t) - \dot{N}_{Mi} A_p M_{w,i} \Delta t, \quad (7)$$

where is the molecular weight of species .

The rate of vaporisation is governed by gradient diffusion with the flux of droplet vapour into the gas phase

$$\dot{N}_{Mi} = k_c (C_{i,s} - C_{i,\infty}), \quad (8)$$

where \dot{N}_{Mi} is the molar flux of the vapour, k_c is the mass transfer coefficient, $C_{i,s}$ is the vapour concentration at the droplet surface, and $C_{i,\infty}$ is the vapour concentration in the bulk gas.

When the droplet temperature reaches the boiling point, a boiling rate equation is applied:

$$-\frac{d(d_p)}{dt} = \left[\frac{2k_\infty [1 + 0.23 \sqrt{Re_d}]}{d_p} (T_\infty - T_p) + \varepsilon_p \sigma (\theta_R^4 - T_p^4) \right]. \quad (9)$$

The particle size distribution after injection of a liquid fuel is defined by fitting the size distribution data to the Rosin-Rammler equation. The Rosin-Rammler distribution function is based on the assumption that an exponential relationship exists between the droplet diameter d and the mass fraction of droplets with diameter greater than d :

$$Y_d = e^{-(d/\bar{d})^n}, \quad (10)$$

where \bar{d} is the size constant and n is the size distribution parameter.

The boundary conditions in the combustion chamber inlets, symmetry axes, walls, and outlet were set in accordance with the conditions for carrying out physical experiments and recommendations for modelling the turbulent burning processes. The method for the system solution of Eqs. (1)-(10), the finite difference scheme, and the solution stability analysis are explained in detail in [30].

Note that the acts of chemical transformation in the combustion chamber occur when molecules collide, while their kinetic energy turns into potential energy and is spent on breaking the bonds in the molecules. However, bond destruction will occur only when the value of the potential energy exceeds a certain limit – the activation energy E . Not all collisions in which the energy exceeds the activation energy lead to a chemical reaction. For this, the appropriate orientation of the molecules among themselves is also necessary. Thus, activation involves the conversion of an average molecule into an active molecule. The smaller the value of E , the higher the reaction rate usually is [31].

The uniqueness of the chain reactions occurring within combustion chambers lies in their multi-step transformation process, leading to the production of various intermediate products such as atomic fragments, radicals, intermediate compounds, etc. It is worth noting that one of the factors of the plasma-chemical impact on hydrocarbon oxidation processes

is the formation of a large number of intermediate and unstable compounds in the process of plasma activation. The addition of plasma-chemical products to the primary zone of the gas turbine combustion chamber leads to a decrease in the activation energy of the hydrocarbon oxidation reactions. As a result, there is a change in the distribution of the flow parameters inside the burning device [19, 20]. Based on the data presented in [19], a correlation was deduced to quantify the effect of the amount of plasma-chemical products β (by volume) on the reduction of the activation energy ΔE for the resulting reaction between the fuel and oxidiser, as depicted in Fig. 1.

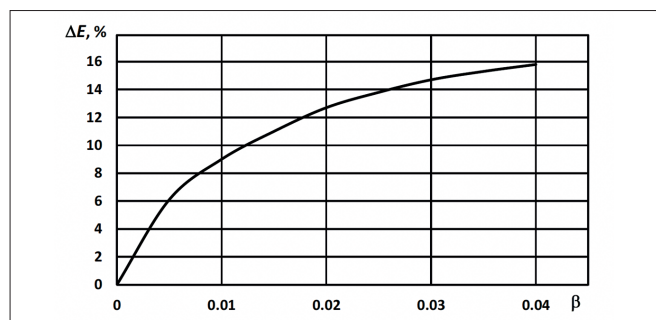

Fig. 1. Dependence of the decrease in the activation energy of the hydrocarbon oxidation reaction on the amount of plasma-chemical products β (by volume)

Approximation of this graphic dependence made it possible to obtain the following formula for reducing the activation energy ΔE depending on the amount of additives (by volume) of plasma-chemical products (reliability of approximation $R^2 = 0.996$):

$$\Delta E = 3.87 \cdot 10^5 \beta^3 - 3.51 \cdot 10^4 \beta^2 + 1.17 \cdot 10^3 \beta + 0.363. \quad (11)$$

This dependence was used when performing three-dimensional calculations of the parameters of a dual-fuel combustion chamber, taking into consideration plasma activation.

To simulate the hydrocarbon oxidation processes in a dual-fuel combustion chamber with plasma assistance, a six-stage burning scheme was used that simulates the oxidation processes of light distillate fuel ($C_{16}H_{29}$) and gaseous methane CH_4 [7, 32]. The simplified kinetic mechanism of combustion is as follows:

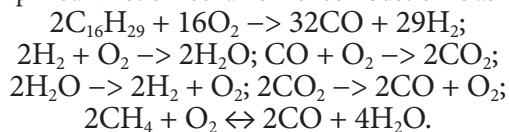

Eqs. (1)–(10) represent a closed system that, under appropriate initial conditions and known characteristics of the gaseous and liquid phases, determines the distribution of the parameters inside the volume of a dual-fuel combustion chamber and the change in time of the transport characteristics of liquid fuel droplets.

STUDY OF THE PARAMETERS OF A DUAL-FUEL COMBUSTION CHAMBER WITH A PLASMA-CHEMICAL ELEMENT

The design scheme of the combustion chamber of a 25 MW gas turbine produced by the “Zorya”-“Mashproekt” research

and production complex (Mykolaiv, Ukraine) with a modified front-end device and an installed plasma-chemical element is shown in Fig. 2.

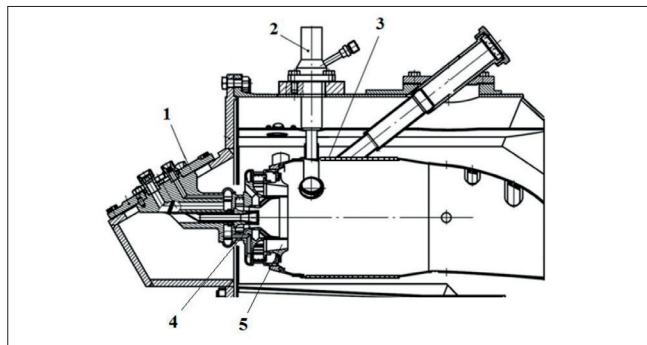

Fig. 2. Location of a plasma-chemical element in the low-emission combustion chamber: 1 – burner device; 2 – plasma-chemical element; 3 – flame tube; 4 – internal radial swirler; 5 – external radial swirler

Compared with the serial combustion chamber, the following design changes are proposed:

1. For more convenient installation, the plasma-chemical element is installed on the outer body of the combustion chamber, and the products of the plasma-chemical transformations are fed into the primary zone of the combustion chamber through the openings of the flame transfer pipes.
2. The supply of liquid fuel to the channels of the internal and external swirlers of the flame tube is carried out via a total of 30 tubes or nozzles, which are evenly distributed throughout the channels of the swirlers.
3. The film cooling system of the serial flame tube is replaced by a convective one, which allows the relative air consumption for cooling the flame tube to be reduced by 1–1.5% [16].

Table 1 presents the initial parameters of a dual-fuel combustion chamber.

Tab. 1. Input parameters for calculating the combustion chamber in nominal mode

Parameter	Value
1. Airflow through the flame tube, kg/s	4.355
2. Average pressure at the outlet of the high-pressure compressor, Pa	2052300
3. Air temperature at the inlet of the chamber, K	770
4. Temperature of the gaseous fuel at the inlet of the chamber, K	288
5. Temperature of the diesel fuel at the inlet of the chamber,	313

The flow rate of plasma-forming air supplied through the plasma-chemical element is 0.5–1.0 g/s and the average temperature of the plasma jet is 2500–4000 K (depending on the electrical power consumed). Inside the plasma-chemical element, a re-enriched fuel-air mixture is provided with air excess coefficients of 0.2–0.4.

To determine the influence of a plasma-chemical element on the characteristics of a dual-fuel gas turbine combustion chamber, calculations of the fuel combustion and emissions of the main pollutants (NO and CO) were carried out for three different modes of fuel supply (1, 2 and 3 in Table 2), which correspond

to the following distributions of the mass consumption of hydrocarbons: mode 1 - 50% liquid and 50% gaseous, mode 2 - 70% liquid and 30% gaseous, mode 3 - 100% liquid. The effect of the plasma-chemical products added to the primary zone of the combustion chamber was analysed, varying the quantity β : 0 (without additives), 0.005, 0.01, 0.015, and 0.02. These quantities correspond to a reduction in the activation energy of the hydrocarbon oxidation reactions by 0%, 6%, 9%, 11%, and 12%, respectively (refer to Fig. 1).

Tab. 2. Fuel consumption through the flame tube for the investigated modes of fuel supply

Mode of operation	Fuel consumption through the flame tube, kg/s			
	Gaseous fuel		Liquid fuel	
	External swirler	Internal swirler	External swirler	Internal swirler
1	0.0472	0.00248	0.00314	0.000165
2	0.0283	0.00149	0.00440	0.000232
3	0	0	0.0944	0.00497

The results of numerical modelling of the processes in a dual-fuel low-emission combustion chamber showed that the addition of plasma-chemical products positively affects the nature of the fuel combustion along the flame tube. The most rational - from the point of view of the energy consumption for the functioning of the plasma system - are the modes of operation at $\beta = 0.01$ and 0.015.

Figs. 2-3 present the temperature distribution of the combustion products in the outlet section of the flame tube for two typical fuel supply modes 3 and 1, respectively. It can be seen that, with the addition of the plasma-chemical products, the average integral temperature of the outlet gases practically does not change.

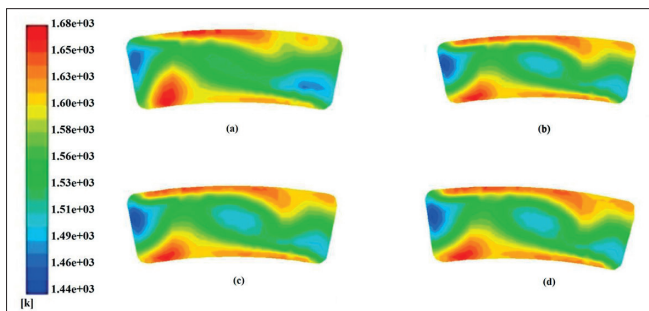

Fig. 2. Distribution of temperatures (K) in the outlet section for the third mode of fuel supply: a - the basic variant without additions of plasma-chemical products; b - $\beta = 0.005$; c - $\beta = 0.01$; d - $\beta = 0.02$

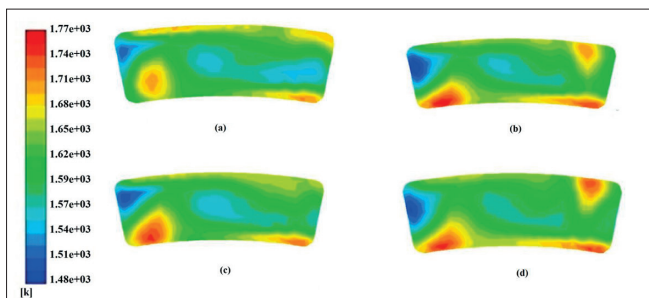

Fig. 3. Distribution of temperatures (K) in the outlet section for the first mode of fuel supply: a - the basic variant without additions of plasma-chemical products; b - $\beta = 0.005$; c - $\beta = 0.01$; d - $\beta = 0.02$

Figs. 4-5 present the distribution of the carbon monoxide CO concentrations in the outlet section of the flame tube for fuel supply modes 3 and 1, respectively. It can be seen that the addition of plasma-chemical products in the amount $\beta \geq 0.005$ causes a significant decrease in CO emissions as a result of the acceleration of the carbon monoxide oxidation reactions and intensification of the mixture formation processes in the primary zone of the combustion chamber. This effect is especially evident when burning liquid fuel.

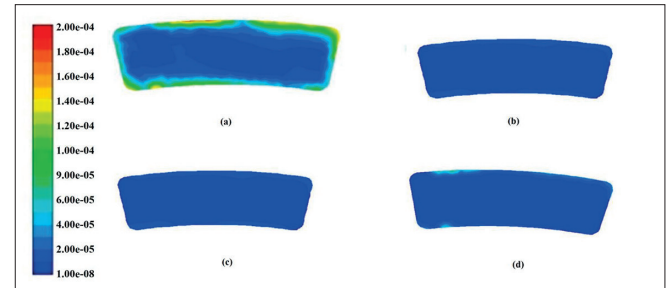

Fig. 4. Distribution of carbon monoxide concentrations at outlet section for the third mode of fuel supply: a - basic version without additions of plasma-chemical products; b - $\beta = 0.005$; c - $\beta = 0.01$; d - $\beta = 0.02$

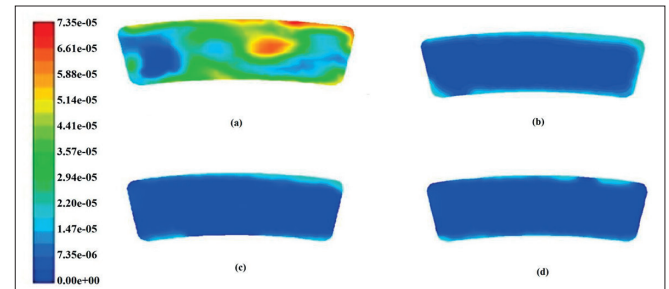

Fig. 5. Distribution of carbon monoxide concentrations at outlet section for the first mode of fuel supply: a - basic version without additions of plasma-chemical products; b - $\beta = 0.005$; c - $\beta = 0.01$; d - $\beta = 0.02$

The following graphs show the temperature distributions (Fig. 6), and the volumetric concentrations of carbon monoxide CO (Fig. 7) and nitrogen oxides NO (Fig. 8) in the outlet cross-section of a dual-fuel low-emission combustion chamber of a 25 MW gas turbine engine for different fuel supply options (without and with the addition of plasma-chemical products into the primary zone of the chamber).

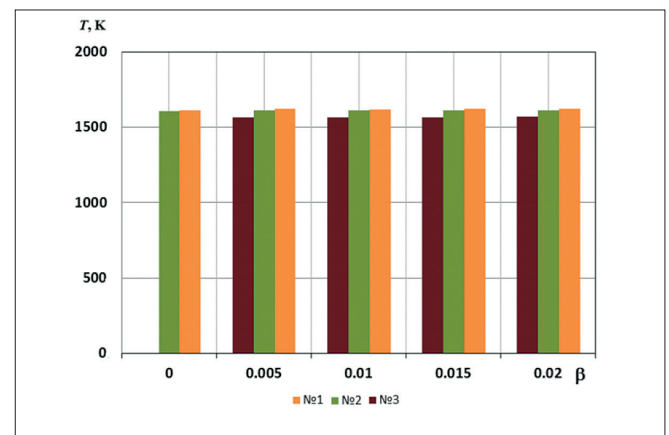

Fig. 6. Dependencies of temperatures in the outlet section of the flame tube on the amount of additives of plasma-chemical products for modes 1-3

FINAL CONCLUSION

A study of the combustion efficiency of fuels differing in phase state in a dual-fuel gas turbine combustion chamber with a plasma-chemical element was carried out, allowing new data to be obtained on the distribution of the main parameters of the flow in the volume of the flame tube and at its outlet for different modes of supply of liquid and gaseous fuels, taking into consideration the amount of plasma-chemical products supplied to the primary zone of the chamber. The intensifying effect of low-temperature air plasma on the environmental parameters of the combustion chamber with preliminary mixing of fuels with an oxidiser in the channels of the radial-axial swirlers of the flame tubes is confirmed. It was established that the addition of plasma-chemical products in the amount of $\beta \geq 0.005$ (by volume) provides a significant reduction in carbon monoxide emissions at the outlet section of the flame tube: from 25–28 ppm to 3.9–4.6 ppm. Also, with the addition of plasma-chemical products, the concentration of nitrogen oxides at the outlet of the combustion chamber changes slightly. We note a significant positive effect of the products of plasma-chemical reactions in expanding the range of stable operation of the combustion chamber. Experimental studies of the system of plasma-chemical intensification for the combustion of hydrocarbon fuels on natural objects should be considered a further direction of the research.

REFERENCES

1. "Gas turbine power solutions minimize weight, footprint on FPSOs." Accessed: Mar. 15, 2023. [Online]. Available: <https://assets.siemens-energy.com/siemens/assets/api/uuid:91faa9eb-0a1e-4f9f-91c8-5a632f89c0da/offshoremag-fpsos-eprint-1811off58-61.pdf>
2. M. Hammer, P. E. Wahl, R. Anantharaman, D. Berstad, and K. Y. Lervåg, "CO₂ capture from off-shore gas turbines using supersonic gas separation," *Energy Procedia*, vol. 63, pp. 243–252, 2014, doi: <https://doi.org/10.1016/j.egypro.2014.11.026>.
3. Y. Gu and Y. Ju, "LNG-FPSO: Offshore LNG solution," *Frontiers of Energy and Power Engineering in China*, vol. 2, no. 3, pp. 249–255, Jul. 2008, doi: <https://doi.org/10.1007/s11708-008-0050-1>.
4. O. Cherednichenko, S. Serbin, and M. Dzida, "Application of thermo-chemical technologies for conversion of associated gas in diesel-gas turbine installations for oil and gas floating units," *Polish Maritime Research*, vol. 26, no. 3, pp. 181–187, Sep. 2019, doi: <https://doi.org/10.2478/pomr-2019-0059>.
5. O. Cherednichenko, S. Serbin, and M. Dzida, "Investigation of the combustion processes in the gas turbine module of an FPSO operating on associated gas conversion products," *Polish Maritime Research*, vol. 26, no. 4, pp. 149–156, Dec. 2019, doi: <https://doi.org/10.2478/pomr-2019-0077>.

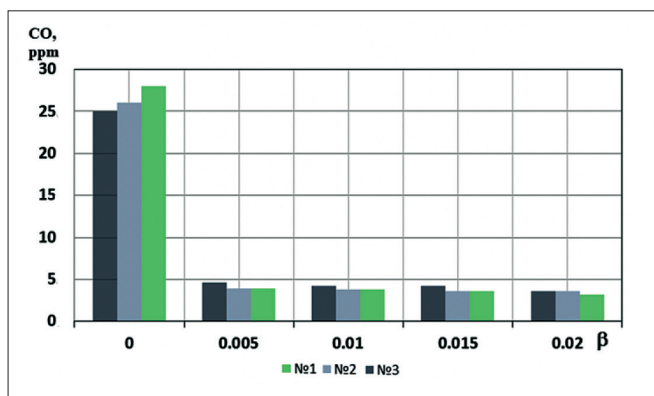

Fig. 7. Dependencies of volume concentrations of CO in the outlet section on the amount of additives of plasma-chemical products for modes 1-3

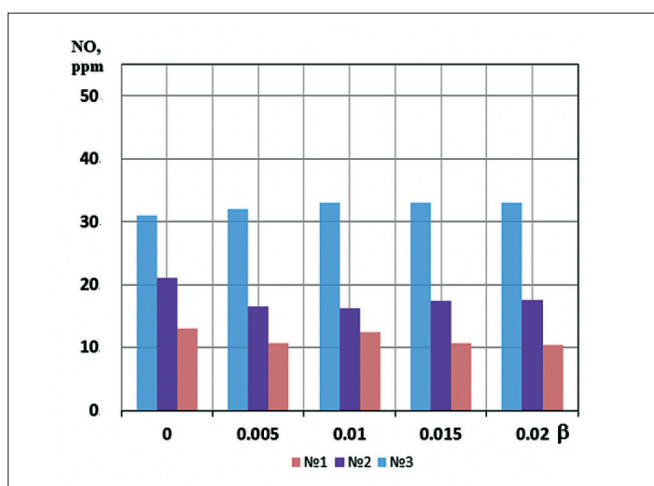

Fig. 8. Dependencies of volume concentrations of NO in the outlet section of the flame tube on the amount of additives of plasma-chemical products for modes 1-3

The analysis of the obtained data revealed that the addition of products of a plasma-chemical element to the primary zone of a dual-fuel gas turbine combustion chamber causes the temperature of the gases at the exit of the flame tube to increase slightly (less than 1%) compared to the variant without the addition of plasma-chemical products. For all three investigated modes of fuel supply (1-3), a significant decrease in the content of carbon monoxide (from 25–28 ppm to 3.9–4.6 ppm) is observed, even with a small amount of plasma-chemical products ($\beta = 0.005$). Further increase in the amount of plasma-chemical products to $\beta = 0.02$ has practically no effect on the CO emissions, as they are at a minimal (practically zero) level. It can be seen that, with the addition of plasma-chemical products, the distribution of nitrogen oxides at the exit of the combustion chamber changes slightly. Moreover, when the combustion chamber operates in transient modes with the use of plasma-chemical elements, an increase can be expected in the burning stability of lean fuel-air mixtures, together with a decrease in the probability of the formation of pulsating combustion modes, and flame extinction.

6. S. Serbin, N. Washchilenko, M. Dzida, and J. Kowalski, "Parametric analysis of the efficiency of the combined gas-steam turbine unit of a hybrid cycle for the FPSO vessel," *Polish Maritime Research*, vol. 28, no. 4, pp. 122–132, Dec. 2021, doi: <https://doi.org/10.2478/pomr-2021-0054>.
7. S. Serbin, B. Diasamidze, and M. Dzida, "Investigations of the working process in a dual-fuel low-emission combustion chamber for an FPSO gas turbine engine," *Polish Maritime Research*, vol. 27, no. 3, pp. 89–99, Sep. 2020, doi: <https://doi.org/10.2478/pomr-2020-0050>.
8. S. Serbin, B. Diasamidze, V. Gorbov, and J. Kowalski, "Investigations of the emission characteristics of a dual-fuel gas turbine combustion chamber operating simultaneously on liquid and gaseous fuels," *Polish Maritime Research*, vol. 28, no. 2, pp. 85–95, Jun. 2021, doi: <https://doi.org/10.2478/pomr-2021-0025>.
9. A. J. Harrison and F. J. Weinberg, "Flame stabilization by plasma jets," *Proceedings of the Royal Society of London. A. Mathematical and Physical Sciences*, Jan. 19, 1971. <https://royalsocietypublishing.org/doi/abs/10.1098/rspa.1971.0015> [Accessed: Mar. 15, 2023].
10. N. A. Gatsenko and S. I. Serbin, "Arc plasmatrons for burning fuel in industrial installations," *Glass and Ceramics*, vol. 51(11–12), pp. 383–386, 1994, doi: <https://doi.org/10.1007/BF00679821>
11. S. I. Serbin, "Features of liquid-fuel plasma-chemical gasification for diesel engines," *IEEE Trans. Plasma Sci.*, vol. 34, no. 6, pp. 2488–2496, Dec. 2006, doi: <https://doi.org/10.1109/tps.2006.876422>.
12. A. Yu. Starikovskii, N. B. Anikin, I. N. Kosarev, E. I. Mintousov, S. M. Starikovskaia, and V. P. Zhukov, "Plasma-assisted combustion," *Pure and Applied Chemistry*, vol. 78, no. 6, pp. 1265–1298, Jan. 2006, doi: <https://doi.org/10.1351/pac200678061265>.
13. L. Massa and J. B. Freund, "Plasma-combustion coupling in a dielectric-barrier discharge actuated fuel jet," *Combustion and Flame*, vol. 184, pp. 208–232, Oct. 2017, doi: <https://doi.org/10.1016/j.combustflame.2017.06.008>.
14. D. K. Dinh, H. S. Kang, S. Jo, D. H. Lee, and Y.-H. Song, "Partial oxidation of diesel fuel by plasma – Kinetic aspects of the reaction," *International Journal of Hydrogen Energy*, vol. 42, no. 36, pp. 22756–22764, Sep. 2017, doi: <https://doi.org/10.1016/j.ijhydene.2017.07.164>.
15. S. Serbin, A. Mostipanenکو, I. Matveev, and A. Tropina, "Improvement of the gas turbine plasma assisted combustor characteristics," *49th AIAA Aerospace Sciences Meeting including the New Horizons Forum and Aerospace Exposition*, Jan. 2011, doi: <https://doi.org/10.2514/6.2011-61>.
16. S. Serbin, A. Kozlovskiy, and K. Burunsuz, "Influence of plasma-chemical products on process stability in a low-emission gas turbine combustion chamber," *International Journal of Turbo & Jet-Engines*, Jan. 2021, doi: <https://doi.org/10.1515/tjj-2020-0046>.
17. S. I. Serbin, A. V. Kozlovskiy, and K. S. Burunsuz, "Investigations of nonstationary processes in low emissive gas turbine combustor with plasma assistance," *IEEE Trans. Plasma Sci.*, vol. 44, no. 12, pp. 2960–2964, Dec. 2016, doi: <https://doi.org/10.1109/tps.2016.2607461>.
18. I. B. Matveev, S. A. Matveeva, E. Y. Kirchuk, S. I. Serbin, and V. G. Bazarov, "Plasma fuel nozzle as a prospective way to plasma-assisted combustion," *IEEE Trans. Plasma Sci.*, vol. 38, no. 12, pp. 3313–3318, Dec. 2010, doi: <https://doi.org/10.1109/tps.2010.2063716>.
19. S. I. Serbin, "Modeling and experimental study of operation process in a gas turbine combustor with a plasma-chemical element," *Combustion Science and Technology*, vol. 139, no. 1, pp. 137–158, Oct. 1998, doi: <https://doi.org/10.1080/00102209808952084>.
20. S. I. Serbin, I. B. Matveev, and G. B. Mostipanenکو, "Investigations of the working process in a 'lean-burn' gas turbine combustor with plasma assistance," *IEEE Trans. Plasma Sci.*, vol. 39, no. 12, pp. 3331–3335, Dec. 2011, doi: <https://doi.org/10.1109/tps.2011.2166811>.
21. S. M. Mousavi, R. Kamali, F. Sotoudeh, N. Karimi, and B. J. Lee, "Numerical investigation of the plasma-assisted MILD combustion of a CH₄/H₂ fuel blend under various working conditions," *Journal of Energy Resources Technology*, vol. 143, no. 6, Oct. 2020, doi: <https://doi.org/10.1115/1.4048507>.
22. I. B. Matveev and S. I. Serbin, "Theoretical and experimental investigations of the plasma-assisted combustion and reformation system," *IEEE Trans. Plasma Sci.*, vol. 38, no. 12, pp. 3306–3312, Dec. 2010, doi: <https://doi.org/10.1109/TPS.2010.2063713>.
23. I. B. Matveev and S. I. Serbin, "Modeling of the coal gasification processes in a hybrid plasma torch," *IEEE Trans. Plasma Sci.*, vol. 35, no. 6, pp. 1639–1647, Dec. 2007, doi: <https://doi.org/10.1109/tps.2007.910134>.
24. B. E. Launder and D. B. Spalding, *Lectures in Mathematical Models of Turbulence*. London: Academic Press, 1972, ISBN 0124380506.
25. I. B. Matveev, S. I. Serbin, V. V. Vilkul, N. A. Goncharova, "Synthesis gas afterburner based on an injector type plasma-assisted combustion system," *IEEE Trans. Plasma Sci.*, vol. 43, no. 12, pp. 3974–3978, 2015, doi: <https://doi.org/10.1109/TPS.2015.2475125>.

26. S. I. Serbin, I. B. Matveev, G. B. Mostipanenکو, "Plasma-assisted reforming of natural gas for GTL: Part II – Modeling of the methane-oxygen reformer," *IEEE Trans. Plasma Sci.*, vol. 43, no. 12, pp. 3964-3968, 2015, doi: <https://doi.org/10.1109/TPS.2015.2438174>.
27. V. Yakhot and S. A. Orszag, "Renormalization group analysis of turbulence: I. Basic theory," *Journal of Scientific Computing*, vol. 1, no. 1, pp. 3-51, 1986.
28. G. M. Faeth, "Structure and atomization properties of dense turbulent sprays," *Symp. (Int.) Combust.*, vol. 23, no. 1, pp. 1345-1352, 1991, [https://doi.org/10.1016/S0082-0784\(06\)80399-1](https://doi.org/10.1016/S0082-0784(06)80399-1).
29. G. Faeth, "Spray combustion models – A review," *17th Aerospace Sciences Meeting*, New Orleans, USA, 1979, <https://doi.org/10.2514/6.1979-293>.
30. ANSYS Fluent Theory Guide. ANSYS, Inc., 2013.
31. A. H. Lefebvre and D. R. Ballal, *Gas turbine combustion: alternative fuels and emissions*. CRC Press, 2010.
32. K. Meredith and D. Black, "Automated global mechanism generation for use in CFD simulations," *44th AIAA Aerospace Sciences Meeting and Exhibit*, Jan. 2006, doi: <https://doi.org/10.2514/6.2006-1168>.