

## **Kinetics of pollutants removal in hybrid treatment wetlands – case study comparison**

Magdalena Gajewska<sup>a</sup>, Katarzyna Skrzypiec<sup>a</sup>, Krzysztof Józwiakowski<sup>b</sup>, Piotr Bugajski<sup>c</sup>

<sup>a</sup> Gdańsk University of Technology, Faculty of Civil and Environmental Engineering, Dept. of Water and Wastewater Technology, Narutowicza St. 11/12, 80-233, Gdańsk, Poland (mgaj@pg.gda.pl, kaskrzy1@student.pg.gda.pl)

<sup>b</sup> University of Life Sciences in Lublin, Faculty of Production Engineering, Dept. of Environmental Engineering and Geodesy, Akademicka St. 13, 20-950, Lublin, Poland (krzysztof.jozwiakowski@up.lublin.pl)

<sup>c</sup> University of Agriculture in Kraków, Dept. of Sanitary Engineering and Water Management, Mickiewicza St. 24/28, 30-059, Kraków, Poland

### **Abstract**

Recent years have seen an increasing interest in hybrid constructed wetland (HCW) systems for domestic sewage treatment. This paper is focused on kinetics of removal of the main pollutants occurring in wastewater i.e. organics expressed as chemical oxygen demand, biochemical oxygen demand and total nitrogen. The purpose of the article is to compare different HCW configurations in terms of mass removal rates (MRR) and removal rate coefficients ( $k_A$  and  $k_v$ ). Analysed data have been collected at two wetland systems, each composed by two subsurface flow beds: horizontal flow (HF) and vertical flow (VF). Reliable evaluation was achieved by using the same composition of influent wastewater in both HCWs. Performance of opposite configurations HF + VF vs. VF + HF was compared after each stage and the overall HCW system. The average mass removal rates of COD, BOD<sub>5</sub> and TN in both systems were similar, respectively: 2.30, 0.98 and 0.40 g m<sup>-2</sup> d<sup>-1</sup>. However, removal rates differ between single wetland beds after each treatment stage.

**Keywords:** wastewater, treatment efficiency, horizontal flow, vertical flow, configuration

## 1 Introduction

Constructed wetlands (CWs) have received a high level of interest over the past decades due to their efficiency, low investment and operating costs and positive environmental impact. For this reason, these facilities have started to be used as a sustainable method of wastewater treatment for small communities and individual households. In terms of the complexity of the processes occurring, constructed wetlands create a more diverse environment compared to conventional treatment technologies [Gajewska, Obarska-Pempkowiak, 2011, Gómez Cerezo et al., 2001, Langergraber et al., 2010, Vymazal, 2005, Vymazal, 2013].

Subsurface hybrid CW systems are composed of filters with different sewage flow patterns: vertical (VF) or horizontal (HF). These systems prove to achieve higher efficiency of pollutants removal combining the benefits of both types of beds. Processes in vertical flow beds are dominated by mineralization of organic matter and ammonia nitrification thanks to better oxygen conditions compared to the horizontal flow beds ensuring better quality of final effluent (lower concentration of organic matter, complete nitrification and partial denitrification). The processes occurring in vertical and horizontal flow beds differ in magnitude depending on the design and mode of operation. In general, VF beds are unsaturated units usually fed periodically, resulting in high oxygen transfer capacity, thereby favoring the process of nitrification within the wetland bed. On the other hand, HF beds are operated mostly under anoxic/anaerobic conditions due to constant saturation of the beds, which makes it a likely environment for denitrification. Horizontal flow beds are also responsible for effective removal of suspended solids and organic matter [Gajewska, Obarska-Pempkowiak, 2011,

Jóźwiakowski et al., 2017, Kadlec, Knight, 1996, Kadlec, Wallace, 2009, Reed et al., 1995].

The results of many studies revealed that the mass removal rate (MRR) of  $\text{NH}_4\text{-N}$  varies only between  $2.13 \pm 1.72 \text{ g m}^{-2} \text{ d}^{-1}$  for HF + VF constructed wetlands and  $2.48 \pm 2.83 \text{ g m}^{-2} \text{ d}^{-1}$  for VF+HF CWs. Hybrid constructed wetlands with multiple stages of VF and HF beds removed on average  $2.33 \pm 2.61 \text{ g NH}_4\text{-N m}^{-2} \text{ d}^{-1}$ . Considering total nitrogen, HF + VF and VF + HF beds combinations are able to achieve MRR on average  $2.74 \pm 1.86$  and  $2.31 \pm 2.10 \text{ g TN m}^{-2} \text{ d}^{-1}$ , respectively. It should be noted that all removal rates exceed the average MRR of single HF systems ( $1.13 \pm 2.01 \text{ g TN m}^{-2} \text{ d}^{-1}$ ) or single VF CWs ( $1.85 \pm 3.66 \text{ g TN m}^{-2} \text{ d}^{-1}$ ). In terms of  $\text{BOD}_5$ , COD, TSS, the mass removal rates in hybrid constructed wetlands did not vary and, also did not differ substantially from single VF and HF constructed wetlands [Kadlec, Knight, 1996, Kadlec, Wallace, 2009, Canga et al., 2011, Vymazal, 2013].

The aim of the paper is to provide an evaluation of performance of HCW with opposite configurations of the beds in respect of pollutants removal rates. Mass removal rates (MRR) and rate constants ( $k$ ) were analysed after each stage of treatment. Within this paper, a statistical analysis of research results was carried out. The division of discharged wastewater into two streams treated in HCWs in two configurations enabled for reliable estimation and very unique results.

## 2 Materials and methods

The investigations were carried out at two constructed wetlands (Dąbrowica I and Dąbrowica II) in Dąbrowica, Poland, southeast part of the country. Analyzed systems were built in 2006 and were designated for the treatment of domestic wastewater from a single household.



In this case subsurface vertical flow (VF) and horizontal flow (HF) beds were used. The scheme of the investigated wetland systems is shown in Figure 1.

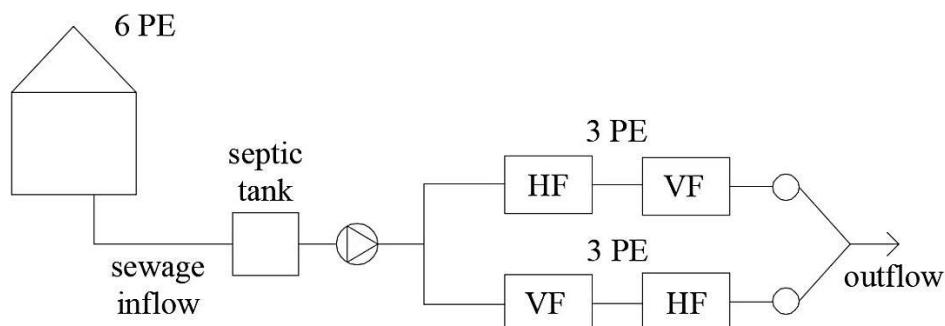

**Fig. 1.** Constructed wetland system in Dąbrowica – general scheme (author's own work).

The analysed wetlands differ from each other in the order of subsequent stages. The characteristic of the systems with configuration of the beds is given in Table 1.

Plant	Flow [m <sup>3</sup> day <sup>-1</sup> ] (pe)	Configu- ration	Area [m <sup>2</sup> ]	Depth of bed [m]	Hydraulic load [mm d <sup>-1</sup> ]	Organics loading rate [g COD m <sup>-2</sup> d <sup>-1</sup> ]
Dąbrowica I	0.3; (3)	HF	24	1.0	12.0	7.021
		VF	24	0.8		
		Σ 48				
Dąbrowica II	0.3; (3)	VF	24	0.8	12.0	7.021
		HF	24	1.0		
		Σ 48				

**Table 1.** The operation conditions of the wetland systems.

Each HCWs system comprised of two beds arranged in series. All beds had dimensions of 6 x 4 m. In the presented case, opposite bed configurations used in these two systems (HF + VF vs. VF + HF) were very valuable for comparison of treatment efficiency due to the identical dimensions of the beds and the same composition of influent wastewater.

Longitudinal sections of the analysed plants are shown on Figure 2 and Figure 3.

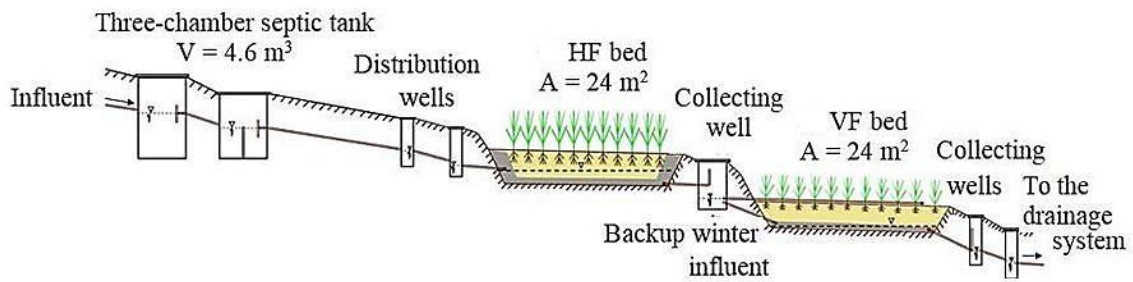

**Fig. 2.** Household HCW system in Dąbrowica – configuration I (longitudinal section) [Józwiakowski, 2012], modified.

As a filter media, gravel and medium sand were selected for both wetland systems. The surface layer of HF bed consists of a humus layer with a thickness of 0.1 m. The following is a 0.6 m layer of sand (grain diameter 1–2 mm). The lower horizontal layer of the bed is 0.2 m thick and consists of gravel with a granulation range of 10–50 mm. Underneath, there is a layer of sand of about 4 cm. VF wetlands are made in the same arrangement of layers, with the difference that the thickness of the sand layer lying under the humus layer is 0.4 m. All wetland beds are isolated from the natural ground using 0.5 mm PEHD geomembrane.

The method of sewage discharge into HF beds is gravitational and feeding regime is continuous, whilst VF beds are fed periodically by means of submersible pumps installed in the wells. Volume of a single loading is 0.3 m<sup>3</sup> with loading intervals set to once per hour. The designed retention time in HF and VF beds was 16 and 9.6 days, respectively. The retention time can be calculated on the basis of the following equation:

$$t_r = (L \times W \times n \times d) / Q \quad (1)$$

where: L – length of the bed (m), W – width of the bed (m), n – porosity of the material from the bed, d – depth of bed (height of the filter bed filled with sewage) (m), Q – average daily inflow of sewage (m<sup>3</sup> d<sup>-1</sup>) [Cooper, 1998, Józwiakowski, 2012].

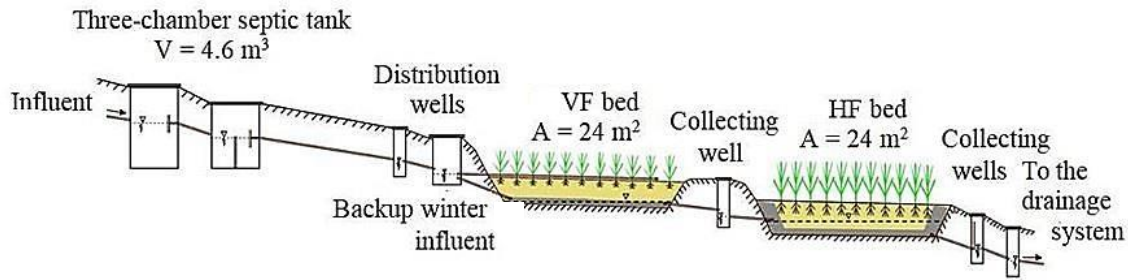

**Fig. 3.** Household HCW system in Dąbrowica – configuration II (longitudinal section) [Jóźwiakowski, 2012], modified.

Horizontal flow beds in the systems were planted with willow (*Salix viminalis*), and for vertical flow beds common reed (*Phragmites australis*) was used.

Data from HCW systems in Dąbrowica I and Dąbrowica II was collected in 2007–2010. Averaged samples of influent and after subsequent stages of treatment in the CW systems were analysed. Number of series of analyses in this study was sixteen as sampling interval amounted to four times a year (February, May, August and November). Overall number of samples taken was 106. In order to evaluate the removal efficiencies, the following parameters were measured: organic matter (COD and BOD<sub>5</sub>) and total nitrogen (TN), according to the methods of Polish Standards in accordance with the standard methods (APHA 2005). Removal efficiency was calculated as a quotient of contaminants concentration difference in influent and effluent after subsequent stages of constructed wetland and concentration in influent. Mass removal rate (MRR) was calculated on the basis of the following equation:

$$MRR = [(C_{in} \times Q_{in}) - (C_{out} \times Q_{out})] / A \text{ [g m}^{-2} \text{ d}^{-1}] \quad (2)$$

where  $A$  is the area of constructed wetland bed [m<sup>2</sup>],  $Q_{in}$  and  $Q_{out}$  are the average influent and effluent flow rates, respectively [m<sup>3</sup> d<sup>-1</sup>],  $C_{in}$  and  $C_{out}$  are average influent and effluent pollutant concentrations, respectively [mg L<sup>-1</sup>] [Gajewska, Obarska-Pempkowiak, 2011, Jóźwiakowski, 2012].

To estimate the rates of removal, the rates of organic matter decay and total nitrogen removal were calculated. It was assumed that the rate coefficients can be described by means of a first-order decay laws. On the basis of the retention time, flow rates, surface bed area and concentrations of organic matter and nitrogen, the decomposition constant coefficients ( $k$ ) for wastewater treated in HF beds and VF beds were calculated. First order equation form presented in (3), which uses the hydraulic retention time ( $t$ ) in days, is dedicated for HF beds:

$$C_{out}/C_{in} = \exp(-k_v t) \quad (3)$$

The following equation was used for the calculation of  $k$ -rates in VF system:

$$C_{out}/C_{in} = \exp(-k_A/q) \quad (4)$$

where  $q$  is the hydraulic loading rate in  $\text{m d}^{-1}$  (calculated as the ratio of the flow rate,  $Q$  in  $\text{m}^3 \text{d}^{-1}$  and surface area,  $A$  in  $\text{m}^2$ ) and  $k_A$  is the decomposition constant in  $\text{m d}^{-1}$  [Brix, Johansen, 1999, Gajewska, Skrzypiec, 2018].

### 3 Results and discussion

The measured influent and effluent concentrations of COD, BOD<sub>5</sub> and TN are presented in Table 2.

	Mean			Median			Standard deviation		
	COD	BOD <sub>5</sub>	TN	COD	BOD <sub>5</sub>	TN	COD	BOD <sub>5</sub>	TN
Influent	408.1	168.7	134.3	395.0	153.5	126.5	94.2	65.9	25.4
HF	174.3	64.7	115.3	172.5	60.8	115.5	58.0	37.8	19.5
VF	46.4	12.2	70.8	42.0	10.6	60.5	32.9	10.2	29.0
VF	54.4	18.4	71.7	28.0	7.3	67.5	86.4	41.1	28.1
HF	40.4	11.7	54.3	27.5	4.8	49.0	60.0	23.5	27.9

**Table 2.** Mean, median and standard deviation of pollutants concentrations ( $\text{mg L}^{-1}$ ) in analysed configurations.

Pollutants concentrations in wastewater in observed HCWs are higher than the most commonly occurring in other European countries [Vymazal, 2007, Molle et al., 2008, Langergraber et al., 2007, Puigagut et al., 2007]. The quality of influent wastewater is



comparable with raw wastewater without pretreatment (France) [Molle et al., 2005, Cooper, 1998] and very typical for Polish rural areas [Gajewska et. al., 2011].

Influent and effluent concentrations of BOD<sub>5</sub> and COD after successive treatment steps in two HCW systems are presented in Figure 4.

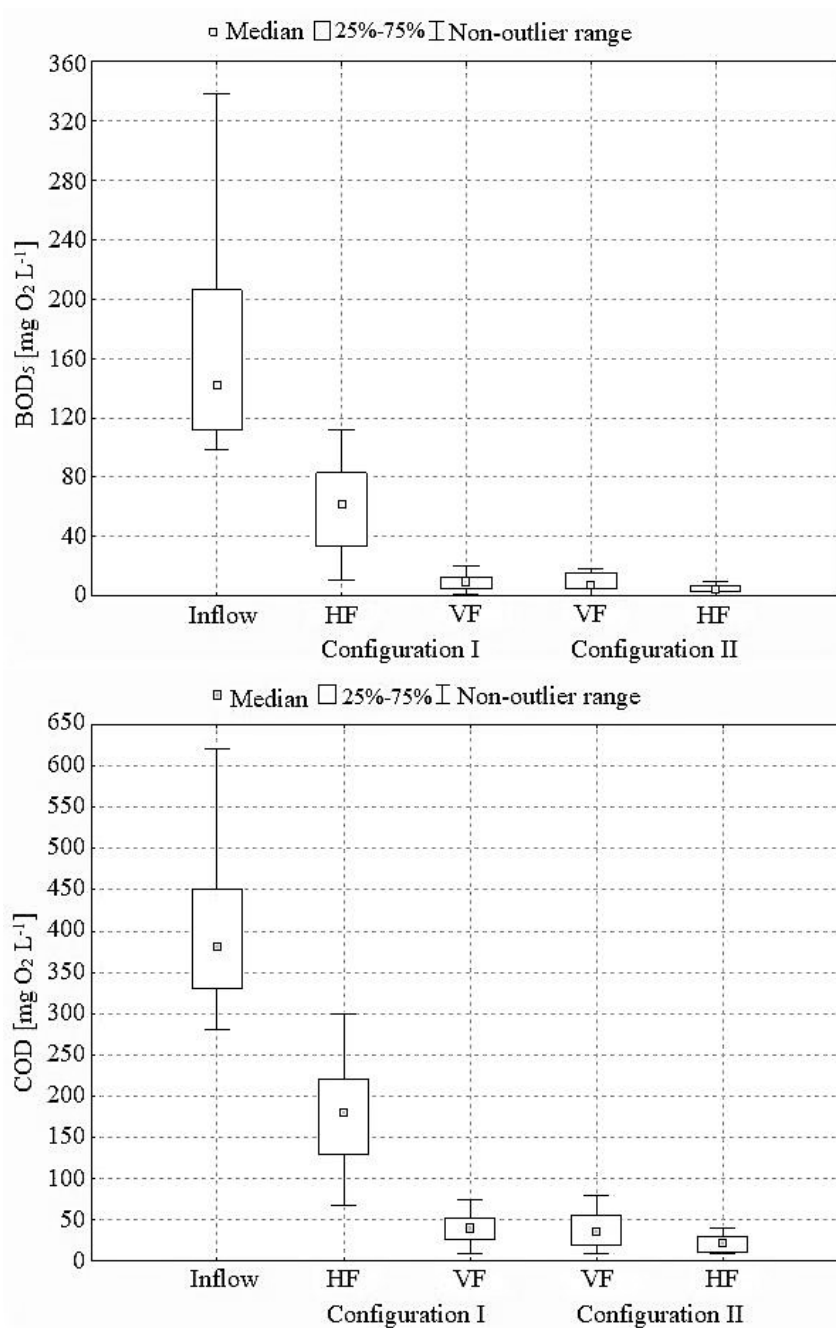

**Fig. 4.** Influent and effluent concentrations of COD and BOD<sub>5</sub> in HCWs.



In the HF + VF system, the removal efficiency of organic compounds expressed as BOD<sub>5</sub> and COD was 93.2% and 89.2%, respectively. In the VF + HF system, reduction rate of 96.8% for BOD<sub>5</sub> and 93.9% for COD was achieved. The median of BOD<sub>5</sub> and COD concentrations in the effluent of this system was 9.6 and 11.0 mg L<sup>-1</sup>, respectively. The median values of BOD<sub>5</sub> and COD in the treated wastewater discharged after the HF + VF system were 4.6 and 23.0 mg L<sup>-1</sup>, respectively. Concentrations of BOD<sub>5</sub> in the effluent of both HCW systems were characterized by high variability, which is confirmed by irregularity coefficients which amounted to 0.87 for the configuration I and a bit lower 0.80 for the configuration II.

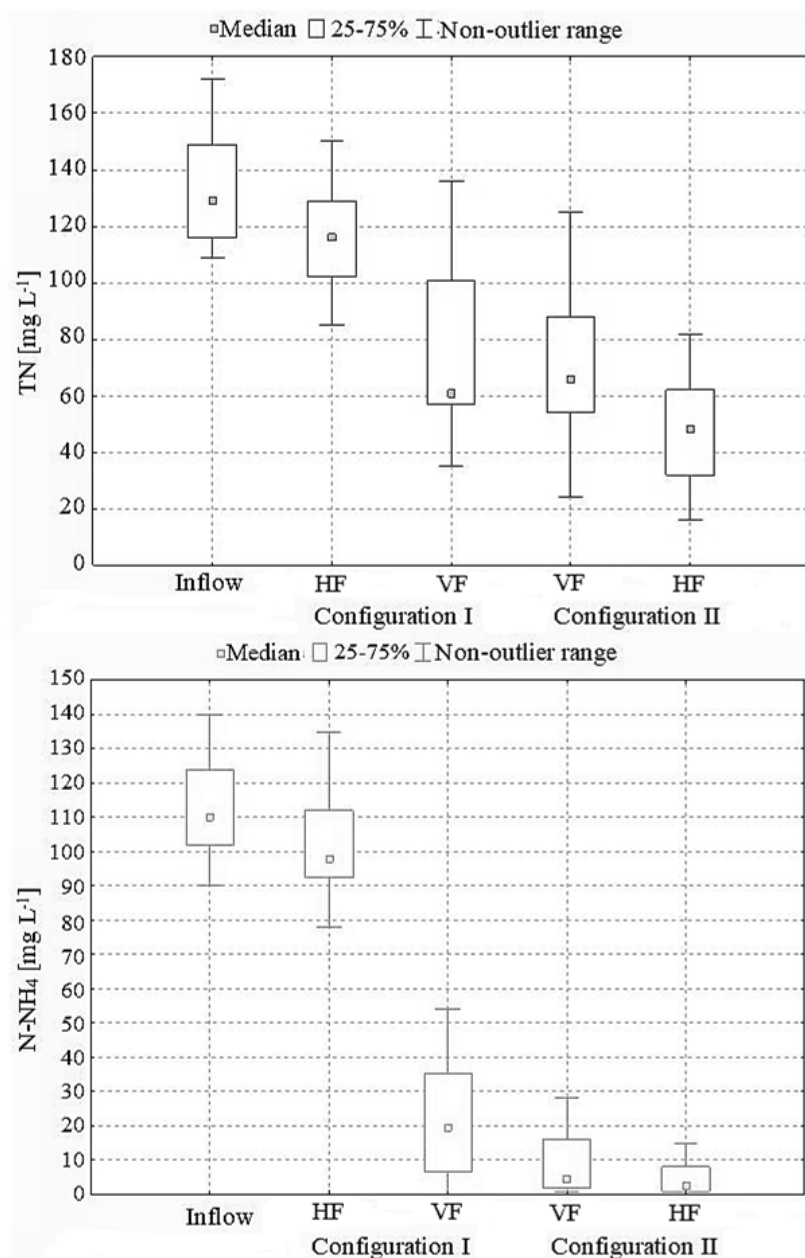

**Fig. 5.** Influent and effluent concentrations of TN and N-NH<sub>4</sub> in HCWs.

The removal of total nitrogen was also uneven in both analyzed HCW systems. In the case of the HF + VF configuration it was found that the efficiency of TN removal was 52.7% and the median in the effluent was 61.0 mg L<sup>-1</sup>. The second system showed higher TN reduction, as the overall removal rate was 62.8%. In the effluent from VF + HF system, the median concentration of total nitrogen was 48.0 mg L<sup>-1</sup> (Fig. 5).

The analysis concerning the performance of two parallel HCW systems showed that higher efficiency of pollution elimination was obtained in vertical-horizontal system (VF + HF). In horizontal-vertical system (HF + VF) low reduction rates of all analyzed parameters were found after first-stage bed in comparison to the first vertical bed in the configuration II. Comparing obtained results, it was stated that in the VF bed working as first stage, reduction of analysed pollutants was higher in comparison to the first-stage HF bed, respectively for BOD<sub>5</sub> by 38.2%, COD by 37.9%, total nitrogen by 38.8% and for ammonium nitrogen by 85.2%. All these findings are very similar to data available in literature [Laber et al., 1997, Vymazal, 2007, Dotro et al., 2017].

Due to different conditions in each bed, different transformations of OM (organic matter) and N occurred and could influence on further removal performance. To analyze wastewater susceptibility to biological decomposition, the BOD<sub>5</sub>/COD ratio was calculated for influent and effluent after each stage of HCWs. The following values are presented in Table 3.

Configuration	BOD <sub>5</sub> /COD ratio								
	Influent			I stage			II stage		
	min	max	mean	min	max	mean	min	max	mean
HF + VF	0.25	0.55	0.41	0.05	0.55	0.36	0.06	1.20	0.33
VF + HF	0.25	0.55	0.41	0.01	1.19	0.32	0.01	1.08	0.30

**Table 3.** Biodegradability of wastewater in analysed HCWs.

Influent wastewater in this case is regarded as vulnerable to biological decomposition to a medium degree. Further on, after first and second stage of analysed configurations, BOD<sub>5</sub>/COD ratio becomes more unfavorable.

Relationships between BOD<sub>5</sub> and TN in influent and after single stages in analysed hybrid systems are shown in Figure 6. The linear regression equation and the coefficient of determination were calculated for each bed.

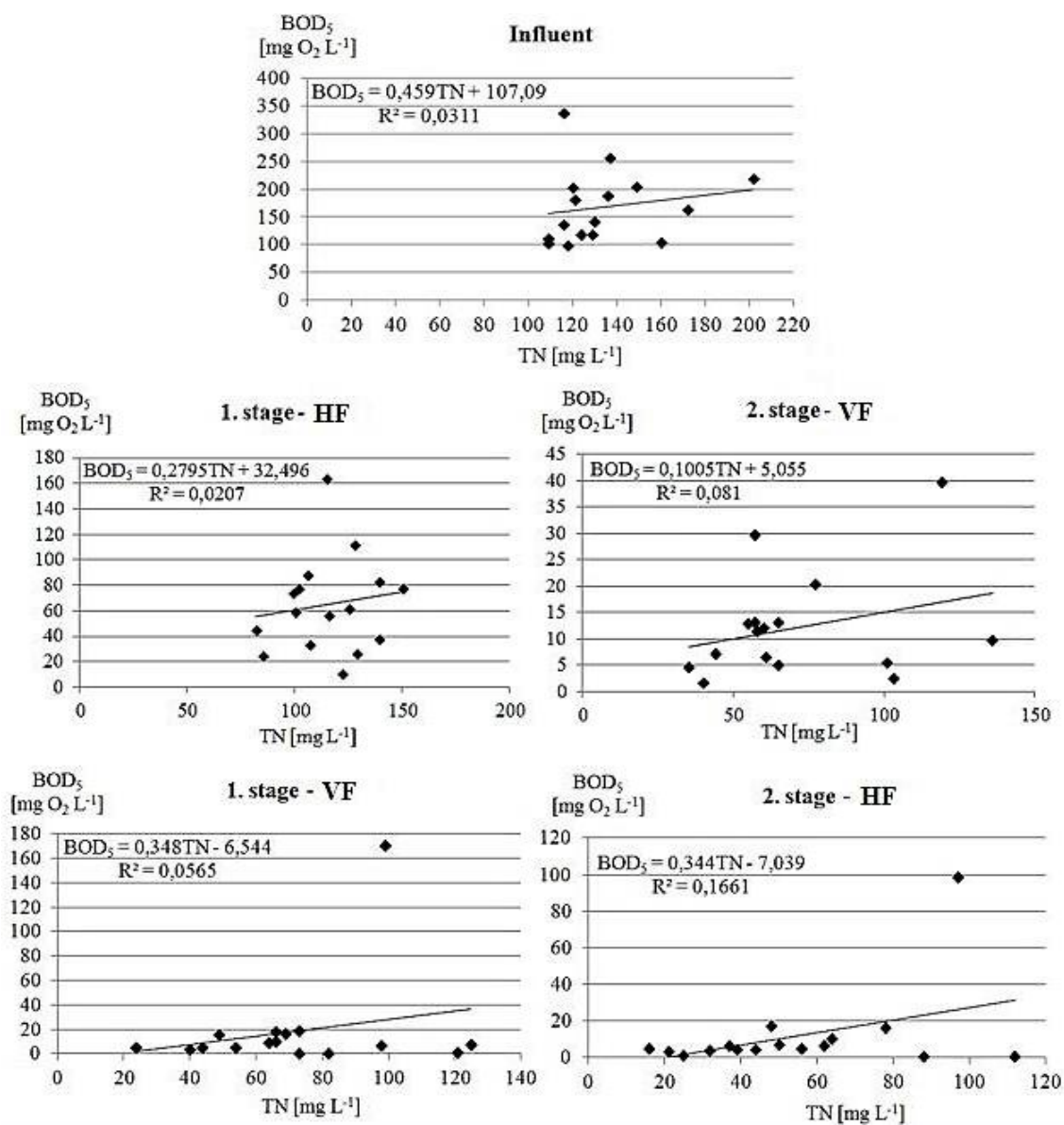

**Fig. 6.** Relationships between BOD<sub>5</sub> and TN for influent, HF + VF and VF + HF configurations.

Total nitrogen concentrations after first stage of treatment were much more differentiated for the bed with vertical flow than with horizontal flow, where the results were around 100-150 mg L<sup>-1</sup>. On the other hand, concentrations of BOD<sub>5</sub> were not dispersed in 1. stage VF bed, contrary to the HF bed in configuration I. Similar situation occurs in the second-stage beds in both systems. In the outflow from the HF bed, the values of total nitrogen concentrations are dispersed, and BOD<sub>5</sub> concentrations usually



do not exceed  $20 \text{ mg L}^{-1}$ . As it can be seen, there is no significant correlation between the studied parameters as coefficients of determination are not significantly high.

Further analysis includes the relationships between pollutant removal rates. In the following Table 4 mean values of mass removal rates in two configurations of wetlands are shown.

	Type of bed	COD	BOD <sub>5</sub>	TN
Configuration I	HF	2.92	1.30	0.24
	VF	1.60	0.66	0.56
Configuration II	VF	4.42	1.88	0.78
	HF	0.18	0.08	0.22

**Table 4.** Average mass removal rates (MRR,  $\text{g m}^{-2} \text{ d}^{-1}$ ) in analysed HCWs.

About 1.5 times higher removal rate of COD was observed in VF bed than in HF bed, both working as first stage. The proportions in removal rates between these two types of beds are less noticeable in case of BOD<sub>5</sub> but still in vertical flow bed removal processes proceeded at a higher rate. Similar conditions are noticed in the first stage of treatment for total nitrogen, where MRR in VF bed was ca. 3 times higher than in horizontal flow bed.

The rate of pollutant removal is typically represented by a rate coefficient,  $k$  (volume-based  $k_v$  in case of horizontal flow beds and area-based  $k_A$  in case of vertical flow beds). This parameter is dependent on factors such as pollutant loading, oxygen transfer, presence of vegetation, etc.  $K$ -rates are usually corrected to a temperature standard of  $20 \text{ }^\circ\text{C}$  in the literature [Gajewska, Skrzypiec, 2018, Kadlec, Knight, 1996]. Correlation levels of the  $k$  constant with the rate of removal of given pollutants are presented in Figs. 7 and 8.



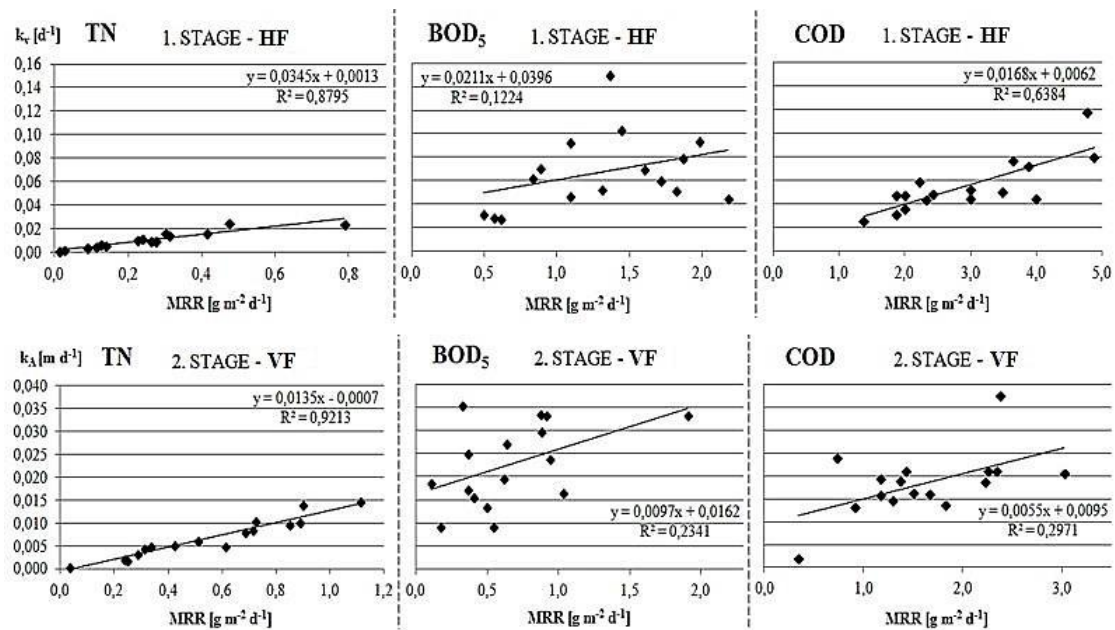

**Fig. 7.** The correlation between main pollutants (TN, BOD<sub>5</sub>, COD) removal constants ( $k_v$ ,  $k_A$ ) and mass removal rates (MRR) of the HF+VF system in Dąbrowica I.

The processes taking place in particular beds are different because of the diversity of kinetics expressed in removal rates. Different wetlands are characterized by different  $k$  rates, but certain tendencies can be observed. The slope of the regression lines is similar for respective parameters of the contaminants. The most significant correlation was found for total nitrogen, since the coefficient of determination in the first-stage HF bed and second-stage VF bed was 87.95% and 92.13%, respectively.

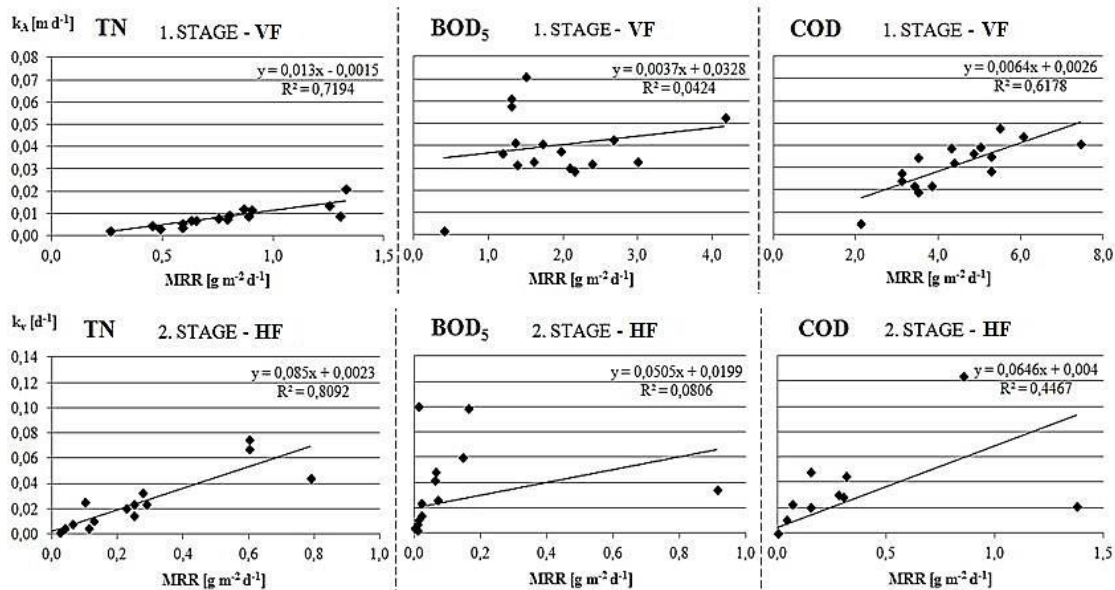

**Fig. 8.** The correlation between main pollutants (TN, BOD<sub>5</sub>, COD) removal constants ( $k_v$ ,  $k_A$ ) and mass removal rates (MRR) of the VF+HF system in Dąbrowica II.

Results for VF + HF system are more varied after each treatment stage. Still the highest coefficient of determination was observed for total nitrogen. Regarding the first-stage beds in both configurations, the overall nitrogen removal rate was higher in the vertical bed (configuration II). Removal of organic matter (BOD<sub>5</sub> and COD) also proceeded more rapidly in the system with VF bed working as a first stage.

The average values of the rate constants and corresponding mass removal rates, for the same relationship as shown in figures above, are given in the Table 5.

		COD		BOD <sub>5</sub>		TN	
		MRR	$k_A/k_V$	MRR	$k_A/k_V$	MRR	$k_A/k_V$
Configuration I	HF	2.92	0.055	1.30	0.067	0.24	0.009
	VF	1.60	0.018	0.66	0.023	0.56	0.007
Configuration II	VF	4.42	0.031	1.88	0.040	0.78	0.009
	HF	0.18	0.015	0.08	0.024	0.22	0.021

**Table 5.** Average proportions between mass removal rates (MRR, g m<sup>-2</sup> d<sup>-1</sup>) and removal constants ( $k_A$ , m d<sup>-1</sup> for VF beds and  $k_v$ , d<sup>-1</sup> for HF beds).

Average values of all parameters are characterized by an increase of k rate with a corresponding increase in the mass removal rate. In general both MRR and k values are

within the ranges of values given in the literature but are in the lowest values. TN MRRs in this study (Table 5) were lower (except for the VF in configuration II) than  $0.7 \text{ g m}^{-2} \text{ d}^{-1}$  reported for systems in Denmark by Brix et al. (2003) and similar MRR values reported by Tanner et al. (2002). The rate constants indicate that organic matter (especially BOD<sub>5</sub>) decomposition was the fastest process, while TN removal was slightly slower. Moreover in the first stage of treatment independently of configuration decomposition rates were higher in comparison to the second stage.

#### 4 Conclusions

The carried out investigation and analyses of achieved results revealed that the configuration with the vertical flow bed at the beginning of treatment process provides better conditions for decomposition and transformation of pollutants, higher efficiency and, as a result, lower effluent concentrations of pollutants. The investigation confirmed very high performance of VF beds. The concentration of ammonium nitrogen dropped down after vertical flow beds what confirmed their high potential for N-NH<sub>4</sub> removal. Thus the configuration with vertical flow beds at the beginning of treatment supported better and more stable performance especially in the case of ammonium nitrogen.

This statement is particularly true in the case of this investigation which enabled to compare two opposite configurations (HF + VF vs. VF + HF) working in the same local conditions in full scale facility and with exactly the same wastewater.

#### References

1. American Public Health Association (APHA) (2005). Standard Methods for the Examination of Water and Wastewater. 21st Edition, American Public Health Association/American Water Works Association/Water Environment Federation, Washington DC.
2. Brix, H., Johansen, N.H. (1999). *Treatment of domestic sewage in a two-stage constructed wetland – design principles*. Nutrient Cycling and Retention in Natural and Constructed Wetland. (Ed. J. Vymazal), The Netherlands, Leiden, Backhuys Publishers, pp.155-165.
3. Brix, H., Arias, C.A., Johansen, N.H. (2003). Experiments in a two-stage constructed wetland system: nitrification capacity and effects of recycling on nitrogen removal, Wetland-nutrient, metal and mass cycling (Ed.) J. Vymazal, Backhuys Publishers, Leiden, The Netherland, pp. 237-258.



4. Canga, E., Dal Santo, S., Pressl, A., Borin, M., Langergraber, G. (2011). Comparison of nitrogen removal rates of different constructed wetland designs. *Wat Sci Technol.* 64(5): 1122-9.
5. Cooper, P. (1998). A review of the design and performance of vertical flow and hybrid reed bed treatment systems. 6th International Conference on Wetland System for Water Pollution Control, Brazil, Chapter IV - Design of Wetland Systems, 229-242.
6. Dotro, G., Langergraber, G., Molle, P., Nivala, J., Puigagut, J., Stein, O.R., von Sperling, M. (2017). Treatment wetlands. *Biological Wastewater Treatment Series, Volume 7*, IWA Publishing, London, UK, 172p. eISBN: 9781780408774.
7. Gajewska, M., Obarska-Pempkowiak, H. (2011). Efficiency of pollutant removal by five multistage constructed wetlands in a temperate climate. *Environ. Prot. Eng.* 37: 27–36.
8. Gajewska, M., Kopeć, Ł., Obarska-Pempkowiak, H. (2011). Operation of small wastewater treatment facilities in a scattered settlement. *Rocznik Ochrony Środowiska, Tom 13 (Tom 1)* 207-225.
9. Gajewska, M., Skrzypiec, K. (2018). Kinetics of nitrogen removal processes in constructed wetlands. *E3S Web Conf.* 26, 00001.
10. Gómez Cerezo, R., Suarez, M.L., Vidal-Abarca, M.R. (2001). The performance of a multi-stage system of constructed wetlands for urban wastewater treatment in a semiarid region of SE Spain. *Ecol. Eng.* 16: 501-517.
11. Józwiakowski, K. (2012). Badania skuteczności oczyszczania ścieków w wybranych systemach gruntowo-roślinnych. Komisja Technicznej Infrastruktury Wsi PAN w Krakowie, Stowarzyszenie Infrastruktura i Ekologia Terenów Wiejskich, Kraków, p. 35, 37, 45-47.
12. Józwiakowski, K., Bugajski, P., Mucha, Z., Wójcik, W., Jucherski, A., Nastawny, M., Siwiec, T., Mazur, A., Obroślak, R., Gajewska, M. (2017). Reliability and efficiency of pollution removal during long-term operation of a one-stage constructed wetland system with horizontal flow. *Sep. Purif. Technol.* 187: 60-66.
13. Kadlec, R.H., Knight, R.L. (1996). *Treatment wetlands*. CRC Press, Boca Raton, USA.
14. Kadlec, R.H., Wallace, S. (2009). *Treatment wetlands, second edition*. CRC Press Taylor & Francis Group, Boca Raton, London, New York, 267-347.
15. Laber, J., Perfler, R., Haberl, R. (1997). Two strategies for advanced nitrogen elimination in vertical flow constructed wetlands. *Water Sci. Technol.* 35(5): 71-77.
16. Langergraber, G., Prandtstetten, C., Pressl, A., Haberl, R., Rohrhofer, R. (2007). Removal efficiency of subsurface vertical flow constructed wetlands for different organic loads. *Water Sci. Technol.* 56(3): 75-84.
17. Langergraber, G., Pressl, A., Leroch, K., Rohrhofer, R., Haberl, R. (2010). Comparison of single-stage and a two-stage vertical flow constructed wetland systems for different load scenarios. *Wat Sci Technol.* 61: 1341-1348.
18. Molle, P., Lienard, A., Boutin, C., Merlin, G., Iwema, A. (2005). How to treat raw sewage with constructed wetlands: an overview of the French systems. *Water Sci. Technol.* 51(9): 11-21.
19. Molle, P., Prost-Boucle, S., Lienard, A. (2008). Potential of total nitrogen removal by combining vertical flow and horizontal flow constructed wetlands: a full scale experiment study. *Ecol. Eng.* 34(1): 23-29.
20. Puigagut, J., Villaseñor, J., Salas, J.J., Becares, E., Garcia, J. (2007). Subsurface-flow constructed wetlands in Spain for the sanitation of small communities: A comparative study. *Ecol. Eng.* 30: 312-319.
21. Reed, S.C., Crites, R.W., Middlebrooks, E.J. (1995). *Natural systems for waste management and treatment*. Second Ed., McGraw Hill, New York, Chapter 6, Wetland Systems, 173-281.
22. Tanner, C.H., Kadlec, H.R., Gibbs, M.M., Sukias, J.P.S., Nguyen, M.L. (2002). Nitrogen processing gradients in subsurface-flow treatment wetlands – influence of wastewater characteristics. *Ecol. Eng.* 18: 499-520,
23. Vymazal, J. (2005). Horizontal sub-surface flow and hybrid constructed wetland systems for wastewater treatment. *Ecol. Eng.* 25: 478-490.



24. Vymazal, J. (2007). Removal of nutrients in various types of constructed wetlands. *Sci. Total Environ.* 380(1-3): 48-65.
25. Vymazal, J. (2013). The use of hybrid constructed wetlands for wastewater treatment with special attention to nitrogen removal: A review of a recent development wastewater. *Water Res.* 47: 4795-4811.