



Mechanical properties and corrosion resistance of dissimilar stainless steel welds

J. Łabanowski*

Department of Materials Science and Engineering, Faculty of Mechanical Engineering, Gdansk University of Technology, ul. Narutowicza 11/12, 80-952 Gdansk, Poland

* Corresponding author: E-mail address: jlabanow@pg.gda.pl

Received 22.10.2006; accepted in revised form 25.01.2007

ABSTRACT

Purpose: The purpose of this paper is to determine the influence of welding on microstructure, mechanical properties, and stress corrosion cracking resistance of dissimilar stainless steels butt welded joints.

Design/methodology/approach: Duplex 2205 and austenitic 316L steels were used. Butt joints of plates 15 mm in thickness were performed with the use of submerged arc welding (SAW) method. The heat input was in the range of 1.15 – 3.2 kJ/mm. Various plates' edge preparations were applied. Microstructure examinations were carried out. Mechanical properties were evaluated in tensile tests, bending tests and Charpy-V toughness tests. Susceptibility to stress corrosion cracking was determined with the use of slow strain rate tests (SSRT) performed in inert (glycerin) and aggressive (boiling 35% MgCl₂ solution) environments.

Findings: All tested joints showed acceptable mechanical properties. Metallographic examinations did not indicate the excessive ferrite contents in heat affected zones (HAZ) of the welds. It was shown that area of the lowest resistance to stress corrosion cracking is heat affected zone at duplex steel side of dissimilar joins. That phenomenon is connected with undesirable structure of that zone consisted of greater amounts of coarse ferrite grains and acicular austenite precipitates. High heat inputs do not deteriorate mechanical properties as well as stress corrosion cracking resistance of welds.

Practical implications: All tested joints showed acceptable mechanical properties. Metallographic examinations did not indicate the excessive ferrite contents in heat affected zones (HAZ) of the welds. It was shown that area of the lowest resistance to stress corrosion cracking is heat affected zone at duplex steel side of dissimilar joins. That phenomenon is connected with undesirable structure of that zone consisted of greater amounts of coarse ferrite grains and acicular austenite precipitates. High heat inputs do not deteriorate mechanical properties as well as stress corrosion cracking resistance of welds.

Originality/value: Mechanical properties and stress corrosion cracking resistance of dissimilar stainless steel welded joints was determined. The zone of the weaker resistance to stress corrosion cracking was pointed out.

Keywords: Crack resistance; Welded joints; Corrosion; Duplex stainless steel

PROPERTIES

1. Introduction

The austenite – ferrite microstructure of duplex stainless steels combine the attractive properties of austenitic and ferritic stainless steels. The duplex grades are highly resistant to chloride stress corrosion cracking, have excellent pitting and crevice

corrosion resistance and are about twice as strong as austenitic steels. The strength and the resistance in corrosive environments make those steels an excellent material for oil, gas and petrochemical industries. There is also a strong trend to use duplex steels for pipelines and cargo holds in chemical tankers.

So far the most common stainless steel used for chemical tankers construction has been the austenitic 316LN grade, and in

lesser extent, 317LN grade. These steels have a good corrosion resistance are easy to form and easy to weld. Utilization of duplex stainless steels in chemical tankers has many advantages over conventional austenitics. Duplex steels show higher pitting corrosion resistance, and enhanced stress corrosion cracking resistance. Due to high yield strength of duplex steels (over 450 MPa) the plate thickness of the tanks can be reduced considerably which gives a weight saving benefits [1-3].

Since the welded joints can be a weak point of whole tank construction much attention has been paid on the weldability aspects of high alloyed stainless steels in the direction to extend their use to more demanding applications.

Austenitic stainless steels weldability is well established. It is necessary to choose consumables that can give 5 to 10 % of delta ferrite in the welded microstructure that is essential to prevent solidification cracking. The heat input is restricted to a maximum of 1.5 kJ/mm and the interpass temperature limited to 100°C for avoid extensive precipitation of brittle phases in weld metal when too slow cooling is applied. Directions for welding technologies indicate that excessive dilution with the base metal should be avoided.

Arc welding of duplex stainless steels can give more or less undesired structures at weld metal or at heat affected zone (HAZ). During welding heat affected zone is brought to a temperature, where the material is almost fully ferritic. Upon cooling a reformation of austenite starts. The extent of ferrite to austenite transformation depends on the steel composition and welding conditions. Higher nickel and nitrogen contents and slower cooling promote this transformation. When cooling is rapid, high ferrite content can remain.

When too high heat input is applied, precipitation of intermetallic phases can occur and phase transformation ferrite to austenite can be suppressed [4,5]. This can significantly reduce mechanical properties and corrosion resistance of the weld [6]. The ferrite content at the weld metal and heat affected zone should be in the range 25-70% to give optimum mechanical properties and corrosion resistance [7, 8].

Submerged arc welding (SAW) gives the higher productivity and can be therefore used for prefabrication of thick plate's tank sections. Application of this efficient welding method for duplex and austenitic plates is considered to be undesirable, as the required high heat input [7]. Other opinions say that thick plates of stainless steels can be successfully welded with the use of higher heat inputs [10]. So far there is not clearly established the upper limit of heat input for duplex and austenitic stainless steels that give joints with mechanical and corrosion properties that can meet requirements of ship classification societies [8,11-19].

In this paper dissimilar, austenitic-duplex welds are considered. Such welds are unavoidable in chemical tankers production [9]. Mechanical properties, microstructure and stress corrosion cracking resistance of the dissimilar welds obtained through the submerged arc welding are presented.

2. Experimental

Three butt joints between plates 15 mm in thickness were performed with the use of SAW method. Plates were made of UR45N+ (UNS 31803) duplex stainless steel and AISI 316L (1.4432) austenitic steel. Chemical compositions and mechanical properties of the steel plates are presented in Tables 1 and 2, respectively.

Table 1.
Chemical compositions of steels used for welding trials, wt %

Material	C	Si	Mn	Cr	Ni	Mo
UR45N+	0.017	0.4	1.5	21.9	5.7	3.0
316L	0.019	0.38	1.7	16.0	11.0	2.5
ESAB 16.86	0.02	0.46	1.6	23.0	8.6	3.1

Table 2.
Mechanical properties of austenitic and duplex stainless steel plates (producer data)

Material	T.S. MPa	Y _P _{min} MPa	A ₅ _{min} %	HV	KV (L) min, J
UR45N+	640-840	460	25	290	90
316L	530-670	220	45	146	90

Table 3.
Welding parameters of dissimilar joints

Thickness mm	Preparation	Number of passes	Heat input kJ/mm	Side/pass
15	Y	4	1.15	1/1
			1.15	1/2
			1.50	1/3
			1.44	2/1
15	2Y	2	2.16	1/1
			2.37	2/1
15	I	2	2.6	1/1
			3.2	2/1

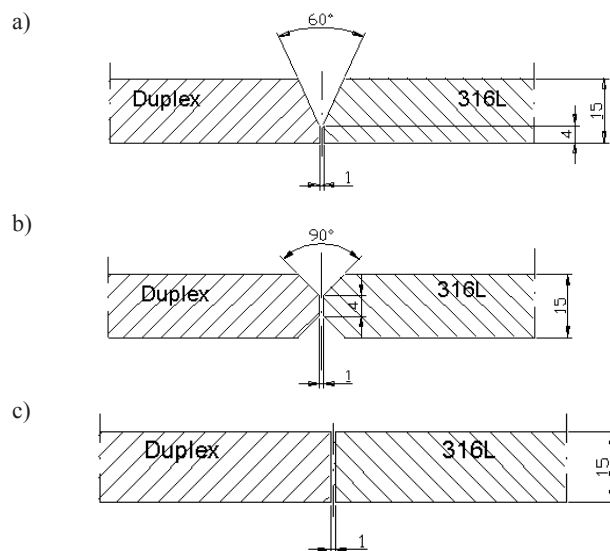

Fig. 1. Edge preparation for dissimilar welded joints; a) Y, b) 2Y, c) I edge preparation

Welded joints were performed using Y, 2Y and I square edge preparations in order to obtain different dilutions between base and welded metal (Fig. 1). Duplex stainless steel filler metal

22Cr-9Ni-3Mo and basic non-alloyed agglomerated flux (ESAB Flux 10.93) was used. The chemical composition of the ϕ 3,2 mm wire is presented in Table 1.

Two or more beds were performed to fill the whole joint with the use of heat input as indicated in Table 3. The interpass temperature was in all cases limited to 100°C maximum. Each weld was X-rayed and crack tested, and found to be satisfactory with B quality class according to PN-EN 25817 standard.

3. Results and discussion

3.1. Metallographic examinations

Metallographic examinations were aimed to determine the general microstructure of the welded metal and heat affected zones. Microscopic observations were performed to find the presence of secondary austenite and precipitations of any intermetallic phases. The width of heat affected zones was established and special attention was paid for seeking any solidification cracking in the weld structure.

Structures of weld metal in all joints were similar. During solidification of duplex weld metal an almost completely ferrite structure is formed. Further cooling initiates the formation of the austenite phase nucleating at the ferrite grain boundaries. In examined welds a dendritic microstructure developed in fast cooling conditions (Fig. 2). More globular structures were observed in areas exposed for lower cooling rates and with a less pronounced heat flow direction.

Heat affected zone microstructure could be critical for welded joint properties [14, 15]. For examined welds the very narrow zones of about 300-500 μ m were observed on the duplex steel side (Fig. 3). The ferrite content in that zone was significantly higher in comparison to bulk weld metal. The width of heat affected zones from 316L steel side (Fig. 4) was extremely narrow and reach 100-150 μ m. The microstructure consists of lamellar ferrite precipitates that surround equiaxial austenite grains. There was no evidence of excessive austenite grain growth.

The ferrite contents in the weld structure were measured along three lines: 2 mm below root and the face of the welds and in the centerline with the use of computer image analysis program MultiScanBase. The results are indicated in Table 4.

Centerlines of the welds contained lesser amounts of delta ferrite. This phenomenon is associated with slower cooling or creation of secondary austenite during reheating by the subsequent beds of the weld. High ferrite contents in the range of 65-72% were recorded at heat affected zones structures at the duplex steel side of the welds. This unfavorable structure does not deteriorate the mechanical properties of the whole joints due to the very low dimensions (width) of this zone.

Table 4.

Ferrite content in welds

	Ferrite content, mean values, %		
	Y joint	2Y joint	I joint
Face line of the weld	55.6	41.1	45.4
Root line of the weld	49.0	46.8	42.7
Centerline	42.0	30.0	35.8
HAZ from duplex side	72.2	65.5	69.3



Fig. 2. Microstructure of the welded metal. Y joint, centerline

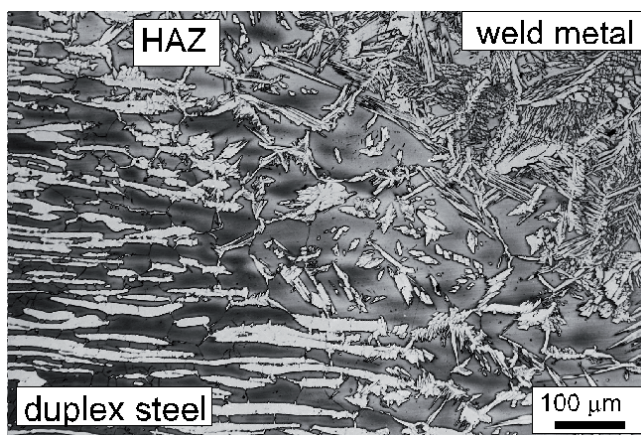

Fig. 3. Heat affected zone microstructure. Duplex steel side. "I" edge preparation weld, face line

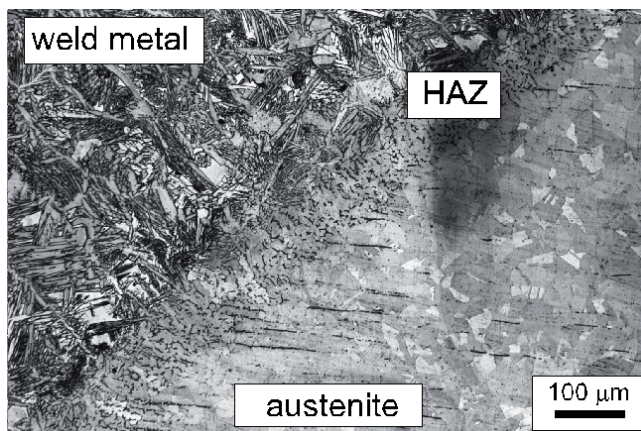

Fig. 4. Heat affected zone microstructure. Austenitic steel side. "I" edge preparation weld, face line

Hot cracks were not observed in weld metal deposits. Liquation cracking is in most cases associated with a combination

of high restraint and weld structure. Weld metals solidifying partly as ferrite shows high resistance to hot cracks formation. The combination of duplex 22Cr-9Ni-3Mo filler and basic flux seems to be a good choice for dissimilar austenite-duplex joints.

3.2. Mechanical properties

Tensile tests were performed on flat specimens 15x18 mm in cross section and weld joint in the center of the gauge length. According to DNV requirements [8] the strength of dissimilar welds is not to be below the minimum tensile strength for the weaker steel grade. The results listed in Table 5 show that this condition was fulfilled for tested joints. All specimens broke in parent material of austenitic steel far away from welded joints (Fig.5).

Table 5.
Tensile test results

Specimen	T.S [MPa] (mean values)	Rapture site
I joint	618	316L steel
2Y joint	613	316L steel
Y joint	619	316L steel



Fig. 5. Tensile test specimen. Square edge preparation weld

Side bend tests were performed according to DNV requirements over the former with the diameter three times that of the specimen thickness (e.g. 45 mm) through the angle 120°. Root and face bend testing were either performed under the same conditions. Bend testing was complicated by the difference in yield strength between two base materials, but can be passed as shown in Table 6 and Fig. 6. No cracks were found on bended surfaces of all tested specimens.

Table 6.
Bending test results

Specimen	Bend angle/ former diameter, mm	Bending side	Result
I joint	120°/45	Face (FBB) and root (RBB)	satisfactory
2Y joint			satisfactory
Y joint			satisfactory

The impact toughness was determined using Charpy-V specimens. Tests were performed at temperature -40°C. The notches were located at the center of the welds and in the fusion lines. Test results are indicated in Table 7. All results were far above these required by the rules [8].

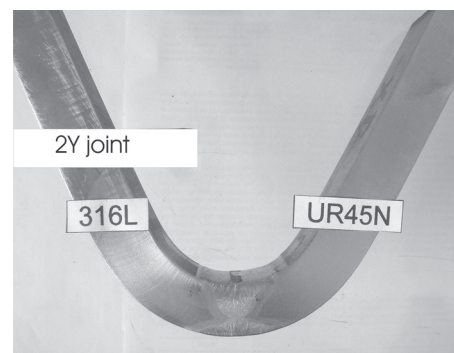

Fig. 6. Bending test specimen. 2Y edge preparation weld

Table 7.
Impact toughness test results

Notch location	Impact Charpy-V toughness at -40°C [J] (mean values)		
	I joint	2Y joint	Y joint
weld centerline	216	154	92
Fusion line 316L steel side	263	255	178
Fusion line duplex steel side	184	206	114
Parent materials			
316L	274		
UR45N	253		

Performed tests show that submerged arc welding could be successfully used for dissimilar joints of austenite and duplex stainless steels if mechanical properties are considered. Application of 22Cr-9Ni-3Mo filler metal provides good strength of the joints. Bend tests and impact tests proved that welded joints fulfill DNV requirements [8] with excess.

3.3. Stress corrosion cracking tests

The susceptibility to stress corrosion cracking was determined in slow strain rate tests (SSRT) with the strain rate of $2.2 \times 10^{-6} \text{ s}^{-1}$ in 35% boiling water solution of MgCl_2 at 125°C. The supplementary tests in an inert environment (glycerin) were also performed. Shape and dimensions of specimens are shown in Fig. 7. Tested zones of specimens contain whole welded joint e.g. weld metal, heat affected zones and base materials.

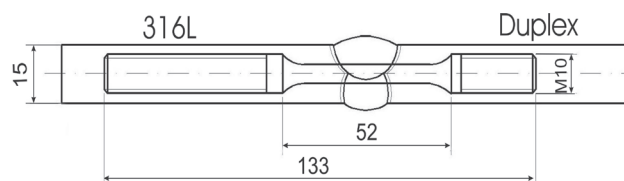

Fig. 7. Specimen for stress corrosion cracking test

Table 8.
Slow strain rate test results

Specimen	Environment	T.S. [MPa]	Elongation %	Red. in area %	Fracture energy MJ/m ³
316L	Glycer.	484	43,2	81,1	174
316L	MgCl ₂	463	28,1	26,9	99
Duplex	Glycer.	628	45,2	76,0	236
Duplex	MgCl ₂	520	23,0	39,2	88
Welded joints					
2Y-G	Glycer.	541	22,7	77,9	106
2Y-Mg	MgCl ₂	407	8,7	26,0	24
I-G	Glycer.	510	26,4	73,5	113
I-Mg	MgCl ₂	461	13,2	27,8	46
Y-G	Glycer.	534	26,5	78,8	114
Y-Mg	MgCl ₂	466	13,7	25,2	49

Maximum force, elongation (E) and fracture energy (En) were recorded during slow strain rate tests. Reduction in area (RA) in fracture zone was also measured. Results of slow strain rate tests for one set of specimens are shown in Table 8 and Fig. 8.

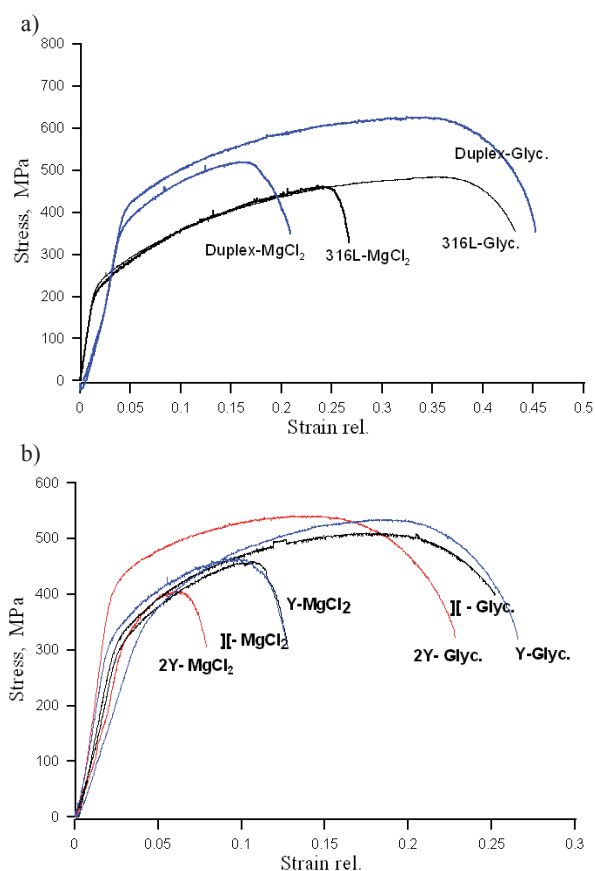

Fig. 8. Stress-strain curves obtained in slow strain rate tests. a) parent materials, b) welded joints. Tests performed in boiling 35% MgCl₂ solution and glycerin

Tests revealed that duplex and 316L steels are susceptible to stress corrosion in magnesium chloride environment. However, dissimilar welded joints exhibited lower susceptibility than base materials. Macroscopic examinations of specimens with the welds performed after SSR tests indicated various places where samples broke. Samples tested in an inert environment broke in weaker material – on 316L steel side. Samples tested in MgCl₂ environment broke on the other side of welded joints – on duplex steel side (Fig.9).

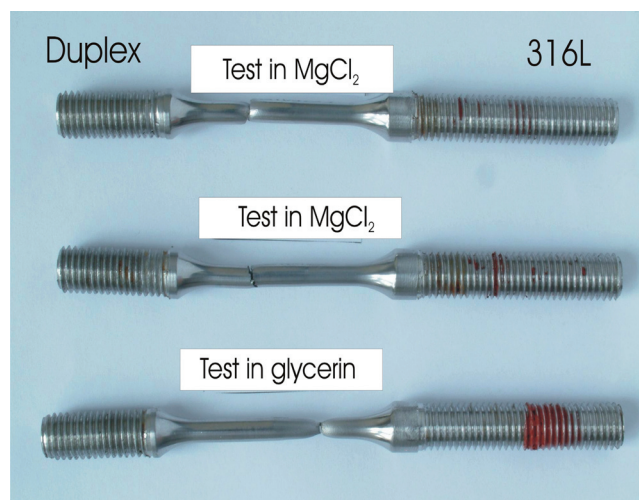

Fig. 9. Samples with welded joints after slow strain rate tests

All specimens with welded joints tested in glycerin at 125°C shown good plasticity and their fracture surfaces were fully ductile (Fig.10). Detailed examinations revealed that these samples broke in parent material – 316L steel close to heat affected zone of the weld. Samples tested in MgCl₂ solution broke in brittle manner. The fracture surfaces of welded specimens exhibit brittle or mixed, ductile-brittle shape. This alternation of plasticity is a result of stress corrosion cracking phenomena [20]. The transgranular fracture surfaces of “I” and “2Y” welded specimens are presented in Fig.11 and 12.

Microscopic examinations of cross sections taken from fracture areas showed that cracks propagate along coarse structure of heat affected zone of duplex steel (Fig.13). Cracks were initiated at the austenite-ferrite phase boundaries. The paths of cracks propagation generally proceed along phase boundaries or across ferrite grains. It was noticed that cracks were frequently stopped on elongated, perpendicular austenite grains, or pass them by.

Various edge preparations and consequently different amount of dilution of parent and welded materials and differences in heat inputs of the welds have no significant effect on crack behavior of tested samples. Structures of heat affected zones of all investigated samples were similar, regardless on heat input applied, and contain about 70% of ferrite with austenite precipitates. That structure occurred as the less resistant to stress corrosion cracking at test conditions.

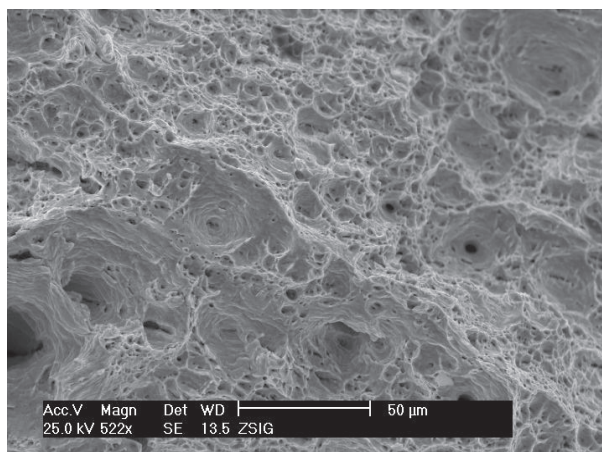

Fig. 10. Fracture surface of “I” welded specimen after SSR test in glycerin at 125°C

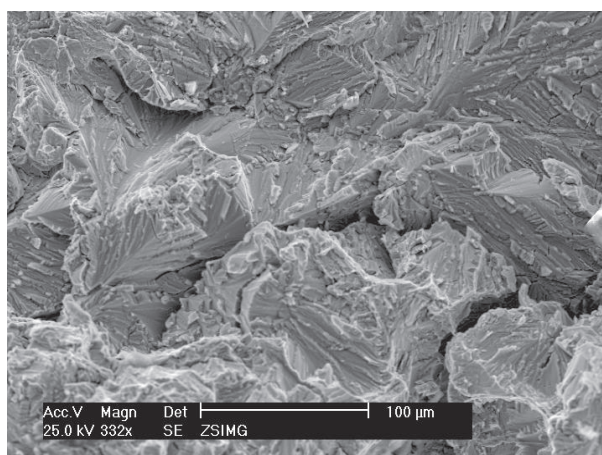

Fig. 11. Fracture surface of “I” welded specimen after SSR test in boiling MgCl₂ solution at 125°C

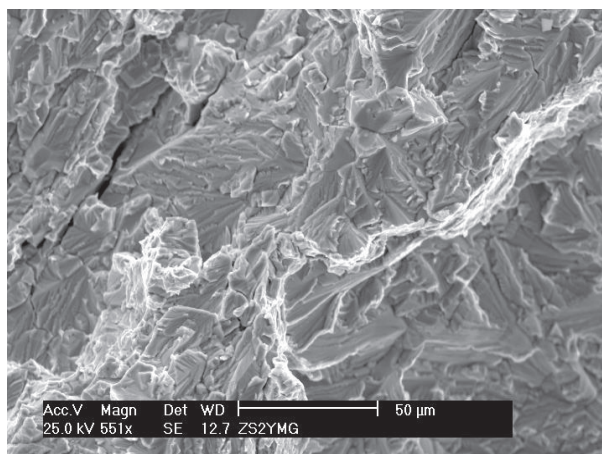

Fig. 12. Fracture surface of “2Y” welded specimen after SSR test in boiling MgCl₂ solution at 125°C

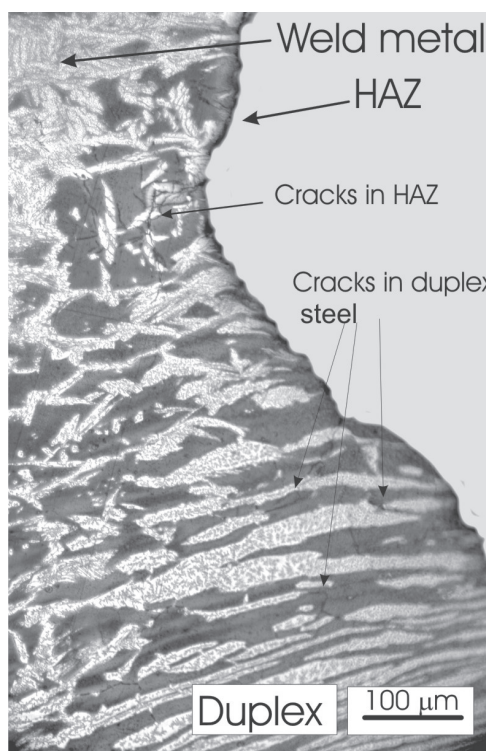
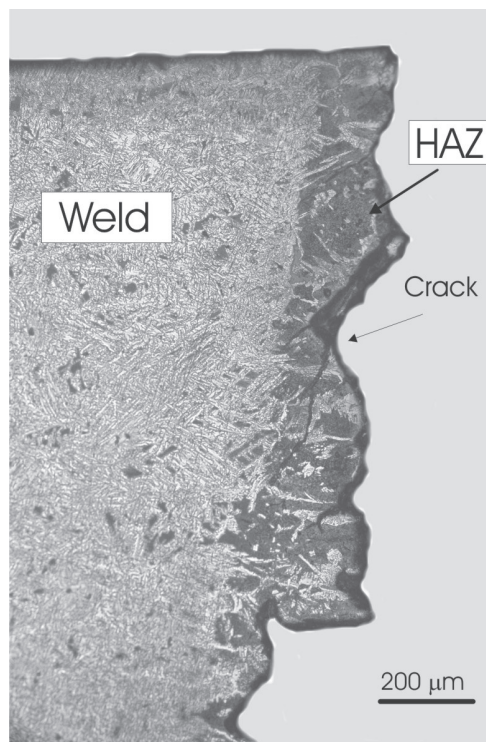

Fig. 13. Crack propagation paths at “I” welded specimen after SSR test in boiling MgCl₂ solution at 125°C

4. Conclusions

1. Submerged arc welding can be used successfully for welding duplex 2205 and austenitic 316L steels when 22Cr-9Ni-3Mo type filler metal is used.
2. All examined welded joints show acceptable mechanical properties that fulfill requirements of Ship Classification Societies.
3. Neither intermetallic particles nor excessive amounts of ferrite were detected in weld metal and heat affected zones structures of stainless steels dissimilar welded joints.
4. Slow strain rate tests performed in MgCl₂ solution environment showed that heat affected zone on duplex stainless steel side is the most susceptible area to stress corrosion cracking of the whole welded joint.
5. Metallographic observations showed that corrosion cracks in HAZ of the welds propagated mainly through ferrite phase, passing by austenite acicular grains.
6. Applied heat inputs in the range of 1.15 – 3.2 kJ/mm and various plate's edge preparations had no significant effect on stress corrosion resistance of welded joints.

Acknowledgements

Author would like to thank the Ministry of Science and Higher Education of the Republic of Poland for financial support of the investigation within the project No. 3 T08C 052 28.

Additional information

The presentation connected with the subject matter of the paper was presented by the authors during the 12th International Scientific Conference on Contemporary Achievements in Mechanics, Manufacturing and Materials Science CAM3S'2006 in Gliwice-Zakopane, Poland on 27th-30th November 2006.

References

- [1] H. Astrom, F. Nicholson, L. Stridh, Welding of stainless steels in the building of chemical tankers. *Welding in the World* 36 (1995) 181-189.
- [2] J. Charles, B. Vincent, Duplex stainless steels for chemical tankers. *Proceedings of the Conference "Duplex Stainless Steel 97"*, KCI Publishing (1997) 727-736.
- [3] J. Łabanowski, Duplex stainless steels - new material for chemical industry. *Apparatus and Chemical Engineering*, 36 (1997) 3-10 (in Polish).
- [4] M. Vasudevan, A. Bhaduri, Baldev Raj, K. Prasad Rao, Delta ferrite prediction in stainless steel welds using neural network analysis and comparison with other prediction methods. *Journal of Materials Processing Technology* 142 (2003) 20-28.
- [5] V. Kuzucu, M. Ceylan, M. Aksoy, M. Kaplan, Investigation of the microstructures of iron based wrought Cr-Ni-Mo duplex alloy, *Journal of Materials Processing Technology* 69, (1997) 247-256.
- [6] J. Łabanowski, Weldability problems of austenite-ferrite stainless steels joining, *Proceedings of the Conference. „Selection of Engineering Materials”*, Jurata 1997, 467-474, (in Polish).
- [7] L. Karlsson, S. Rigdal, S. Andersson, Welding of highly alloyed austenitic and duplex stainless steels, *Welding in the World* 39 (1999) 99-110.
- [8] Det Norske Veritas. *Rules for Classification. Ships. Materials and Welding. Part 2, Chapter 3*, January 2003.
- [9] L. Karlsson, Welding of dissimilar metals, *Welding in the World* 36 (1995) 125-132.
- [10] N.A. McPherson, K. Chi, T.N. Baker, Submerged arc welding of stainless steel and the challenge from the laser welding process, *Journal of Materials Processing Technology* 134 (2003) 174-179.
- [11] J. Nowacki, A. Łukojć, Structure and properties of the heat-affected zone of duplex steels welded joints, *Journal of Materials Processing Technology* 164-165 (2005) 1074-1081.
- [12] J. Nowacki, P. Rybicki, The influence of welding heat input on submerged arc welded duplex steel joints imperfections. *Journal of Materials Processing Technology*, 164-165 (2005) 1082-1088.
- [13] J. Nowacki, P. Rybicki, Influence of heat input on corrosion resistance of SAW welded duplex joints. *Journal of Achievements in Materials and Manufacturing Engineering* 17 (2006) 113-116.
- [14] S. Jana, Effect of heat input on the HAZ properties of two duplex stainless steels, *Journal of Materials Processing Technology* 33(1992) 247-261.
- [15] J. Ku, N. Ho, S. Tjong, Properties of electron beam welded SAF 2205 duplex stainless steel, *Journal of Materials Processing Technology* 63, (1997) 770-775.
- [16] V. Muthupandi, P. Srinivasan, S. Seshadri, S. Sudaresan, Effect of weld metal chemistry and heat input on the structure and properties of duplex stainless steels welds, *Materials science and Engineering A358* (2003) 9-16.
- [17] T. Nelson, J. Lippold, M. Mills, Nature and evolution of the fusion boundary in ferritic-austenitic dissimilar weld metals, Part 1: Nucleation and growth, *Welding Journal* 78 (1999) 329-337.
- [18] T. Nelson, J. Lippold, M. Mills, Nature and evolution of the fusion boundary in ferritic-austenitic dissimilar weld metals, Part 2: On-cooling transformations, *Welding Journal* 10 (2000) 267-277.
- [19] C. Pan, Z. Zhang, Morphologies of the transition region in dissimilar austenitic-ferritic welds, *Materials Characterization* 36 (1996) 5-10.
- [20] J. Łabanowski, Stress corrosion cracking susceptibility of dissimilar stainless steel welded joints, *Journal of Achievements in Materials and Manufacturing Engineering* 20 (2007) 255-258.