

Method using square pulse excitation for high-impedance spectroscopy of anticorrosion coatings

Jerzy Hoja and Grzegorz Lentka

Department of Optoelectronics and Electronic Systems
 Faculty of ETI, Gdansk University of Technology
 Gdansk, Poland

hoja@eti.pg.gda.pl; lentka@eti.pg.gda.pl

Abstract— The paper presents a method of impedance spectroscopy designed for a diagnostics of anticorrosion coatings on objects directly in the field. To shorten the time of impedance spectrum estimation (in the range from 1 mHz to 1 MHz) down to a few minutes, harmonic signals were used to determine the spectrum above 100 Hz and a square pulse in the low frequency range. To determine the impedance spectrum DSP algorithms adequate to the excitation signal were used. In the high frequency range DFT was used, but in the low frequency range continuous Fourier transformation calculated in 8 segments of acquisition, which are dependent on pulse duration time. The performed simulation tests proved the usefulness of the method for impedance spectroscopy of anticorrosion coatings with a relative error of the impedance modulus $\pm 1\%$ and absolute error of the impedance argument $\pm 0.5^\circ$.

Keywords- impedance measurement, impedance spectroscopy, anticorrosion coating diagnostics, DFT, DSP, pulse excitation.

I. INTRODUCTION

Impedance spectroscopy is a research method well-known for many years. In spite of time passage, it is still being developed and improved. On the one hand the technology progress (e. g. new operational amplifiers, fast processors) allows more precise impedance measurement causing the application of the method in new disciplines like biology, medicine (e.g. in dermatological and dental research), on the other hand the technology progress causes that new objects appears requiring to measure higher and higher impedances in a wider and wider frequency range (e.g. fuel cells, concrete composite or high-thickness anticorrosion coatings).

One of the important applications of impedance spectroscopy is characterization of protective properties of anticorrosion coatings on the basis of their impedance, in order to determine whether the coating is good or bad and requires renovation [1]. To determine the coating condition it is enough to know the frequency characteristic of the impedance modulus and argument. Fig. 1 shows how the change of parameters influences the impedance modulus spectrum.

Modern high-thickness anticorrosion coatings are characterized by very high impedance ($|Z_x| > 1 \text{ G}\Omega$), so, in order to evaluate such coatings it is necessary to determine the impedance spectrum in a wide frequency range including very

low frequencies (e.g. from 1 mHz). This kind of test is performed in the laboratory as well as in the field, directly on the real-life objects (bridges, pipelines, etc.), so it is necessary to develop a method which will be possible to be implemented in portable instrumentation for impedance spectroscopy [2]. Due to long measurement time at very low frequencies, traditional impedance spectroscopy (determines the spectrum point by point, measuring impedance with harmonic signals at sequentially selected frequencies) cannot be used in the field-worthy instruments (total measurement time is longer than one hour). Because of this, authors used square pulse excitation, which shortens high-impedance spectrum determination down to a few minutes.

The paper presents a method for determination of the impedance spectrum based on analysis in the time domain of two signals: current through and voltage across the measured object when it is excited by a square pulse. The algorithm of frequency selection of spectrum lines was proposed to minimize the error of modulus and argument determination. The effectiveness of the proposed algorithm was not good enough for spectrum lines above 100 Hz, so to measure impedance in this frequency range the harmonic signals were

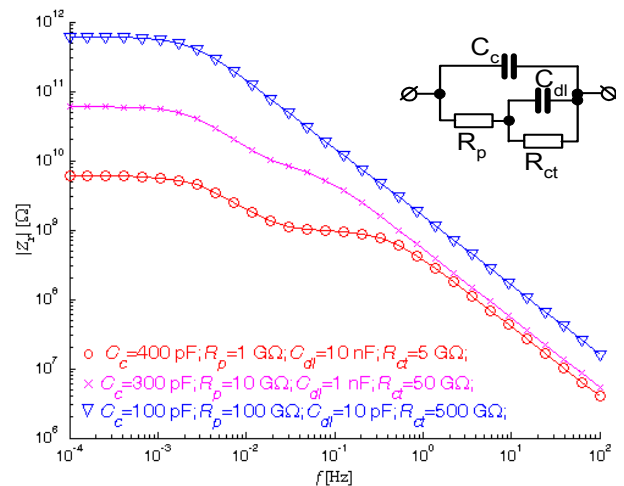

Figure 1. Equivalent circuit and impedance modulus spectrum of the anticorrosion coating in different stage of exploitation from new (∇) to undercoating rusting (\circ).

used, which slightly influences the total time of impedance spectroscopy. In the lower frequency range (below 0,1 Hz), in order to achieve good accuracy of impedance measurement, two AD converters working in parallel were used to sample the current signal.

II. THE PRINCIPLE OF IMPEDANCE MEASUREMENT

There are proposals [3, 4] of shortening the traditional impedance spectroscopy by the use of a non-harmonic excitation signal, e.g. in the patent [5] a Dirac-delta pulse was used, and in [6] a square pulse. Unfortunately, the mentioned methods cannot be used for impedance spectroscopy of anticorrosion coatings. The limitations appear, among other things, due to the structure of the equivalent circuit of the coating (Fig. 1), especially due to placement of the capacitance of the coating C_c . When exciting using the above-mentioned signals, for lack of limitation of the charging current of capacitance C_c , the very high current pulse appears (theoretically infinite) impossible to measure.

The solution proposed by the authors adds controlled limitation of the charging current of C_c with the aid of resistor R_o . This solution has some similarities to the proposal presented in [7], where the current pulse generated using a galvanostat (current source) was used as the excitation signal. In case of testing of performance of anticorrosion coatings, the galvanostat is not required, so the proposed solution, designed for portable instruments, uses a much simpler excitation method for testing the coating Z_x (Fig. 2).

The excitation signal for the measured impedance Z_x in the form of a single square pulse or harmonic signal are generated with the aid of a DA converter. In order to limit the maximum value of current $i_x(t)$ flowing through the measured object, the programmable resistor R_o was used. The current $i_x(t)$ is converted to voltage $u_i(t)$ in a current-to-voltage converter realized using amplifier A3. The change of the converted current range is performed with the aid of programmable resistor R_R (it was assumed that $R_o = 0.1 R_R$). When exciting with a square pulse (1 V amplitude) the voltage $u_i(t)$ changes in a wide range (max.-min. +10 V –10 V), so it is converted by two 12-bit bipolar ADCs working in parallel, with different full scale ranges $U_{FS} = 10\text{ V}$ and 0.01 V, which together allow to obtain current measurement in the range of 5 decades.

The measurement of voltage $u_u(t) = u_x(t)$ across impedance Z_x is performed in the measurement path containing amplifier A2 (with gain of 1) and a 12-bit AD converter. The voltage shape is mainly dependent on the time constant created by

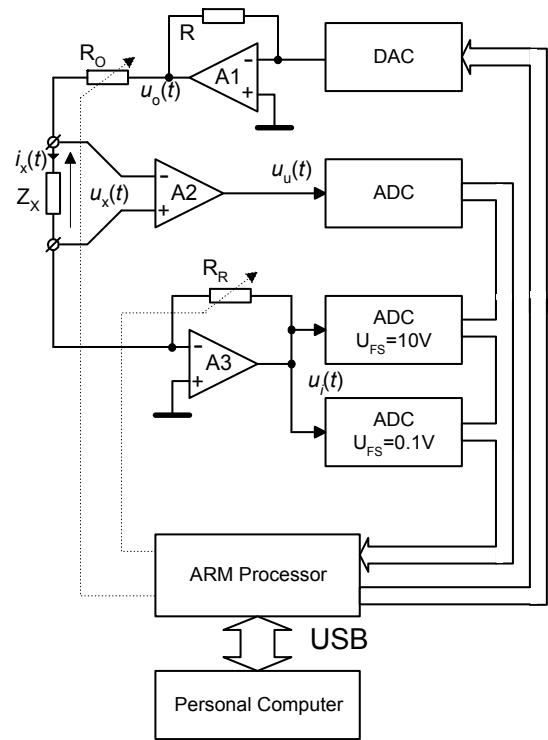

Figure 2. Block diagram of the impedance analyzer

resistor R_o and capacitance C_c in the object equivalent circuit. The used solution allows to supply Z_x with a non-ideal square pulse and allows selection of optimal range resistor R_R (also R_o) and pulse duration time.

The acquired samples of signals $u_i(t)$ and $u_u(t)$ contain information about impedance Z_x as a function of frequency. To determine the spectra of both signals, Fourier transformation can be employed after approximation of the time response using linear functions. Due to the duration time of the excitation pulse (max. value of τ_{imp} up to several seconds) and samples acquisition time (T_{acq} can be of the order of a few minutes), it is difficult to sample signals with a constant step, because it leads to acquisition of a huge number of samples of each signal. So, in the presented solution the acquisition time was divided into segments in which sampling is performed with a different frequency.

The acquisition time is divided into 8 segments whose limits are dependent on the pulse duration time (Fig. 3). Three segments were assumed during the pulse duration time τ_{imp} (with limits $0.01 \tau_{imp}$, $0.1 \tau_{imp}$ and τ_{imp}) and other three segments

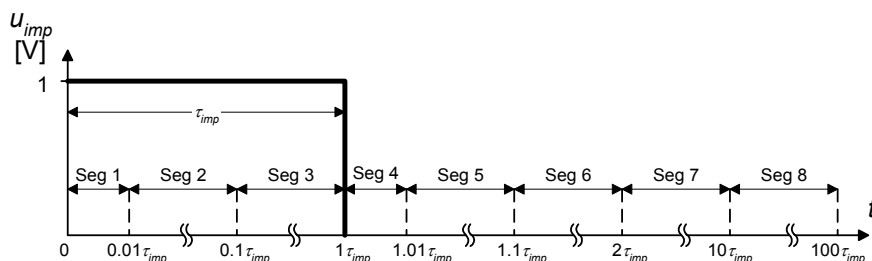

Figure 3. Time segments of sampling process of object response on excitation with square pulse

are placed after pulse. Moreover two segments (7 and 8) with limiting values $10\tau_{imp}$ and $100\tau_{imp}$ were added in order to extend the impedance spectrum in the range of low frequencies. Each of the eight segments contains 1000 samples, so the total number of acquired samples is equal to 8000.

Because samples of signals $u_i(t)$ and $u_u(t)$ are not equally spaced, transformation to the frequency domain cannot be done using DFT, but it is calculated using definition. At the last stage, on the basis of spectra of signals proportional to current through and voltage across the measured object, using impedance definition, the impedance spectrum is calculated.

Acquisition time $T_{acq} = 100 \cdot t_{imp}$ (e.g. for $\tau_{imp} = 2.5$ s; $T_{acq} = 250$ s) influences the minimal (lower) limit frequency of the spectrum, which can be determined from acquired samples ($f_{low} = 4$ mHz):

$$f_{low} = 1/T_{acq} \quad (1)$$

Additionally, T_{acq} determines the density of lines in the spectrum Δf (in the calculated spectrum, the lines are placed at $\Delta f = 4$ mHz distances).

$$\Delta f = 1/T_{acq} \quad (2)$$

High frequency limit of the obtained spectrum depends on the maximum sampling frequency f_{smax} , which is determined by the shortest segment ($0.01 \cdot \tau_{imp}$) (25 ms for $\tau_{imp} = 2.5$ s) and the number of samples in this segment (1000) on the basis of (3):

$$f_{smax} = 1000/(0.01 \cdot \tau_{imp}) \quad (3)$$

(in the example $f_{smax} = 40$ kHz). This means that the maximum frequency f_{high} in the calculated spectrum will be equal to half of the sampling frequency:

$$f_{high} = 1/2 \cdot f_{smax} \quad (4)$$

and the number of lines in the spectrum K is:

$$K = f_{high}/f_{low} \quad (5)$$

in the presented example $K = 5$ millions.

III. THE LIMITATIONS OF THE METHOD OF IMPEDANCE SPECTRUM DETERMINATION

In order to show limitations of determination of the impedance spectrum, simulation tests of the presented method were performed. For tests, the four-element two-terminal RC network shown in Fig. 1 was used with the following values of components: $C_c = 300$ pF, $R_p = 10$ G Ω , $C_{dl} = 2.2$ nF, $R_{ct} = 5$ G Ω . The test object represents the equivalent circuit of a high-thickness anticorrosion coating in the early stage of undercoating rusting.

The determined spectra of modulus $|U_i|$ and $|U_u|$ of signals $u_i(t)$ and $u_u(t)$ are given by a function of $\sin(x)/x$ type, where $x = \pi \cdot k \cdot \tau_{imp}/T_{acq}$ (k – spectral line number). Exemplary spectra

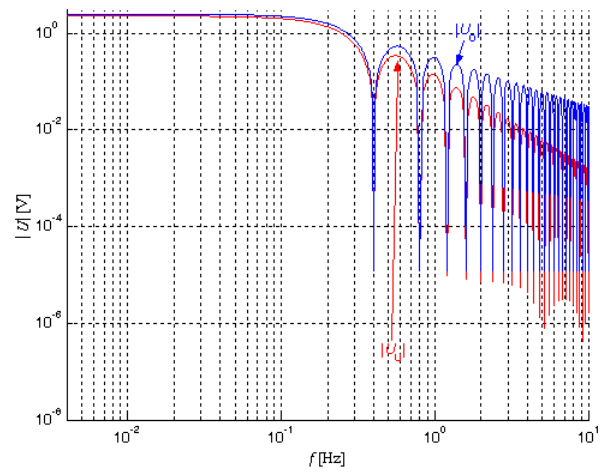

Figure 4. The spectra of modulus of two signals: ideal square pulse (blue) and voltage across Z_x (red)

of modulus of square pulse $u_o(t) \rightarrow |U_o|$ ($\tau_{imp} = 2.5$ s) and voltage response $|U_u|$ across the measured impedance Z_x , are shown in Fig. 4. Simulation was performed for the range resistor $R_R = 1$ G Ω ($R_o = 100$ M Ω) and the ideal ADCs.

The spectra reach minimal values (theoretically with value 0) at points where the argument of the $\sin()$ function reaches the value $m \cdot \pi$, ($m = 0, 1, 2, \dots$) that means $m \cdot \pi = \pi \cdot k \cdot \tau_{imp}/T_{acq}$, so for lines with numbers satisfying equation (for the analyzed example for each 100-th line):

$$k = m \cdot T_{acq}/\tau_{imp} \quad (6)$$

Because the function describing the spectrum reaches minimal values in given lines, this leads in the procedure of impedance calculation (division of value of voltage line by value of current line) to very high deviation of values of impedance modulus (Fig. 5), which causes errors (in the presented frequency range) with the maximum value reaching a few tens of percent.

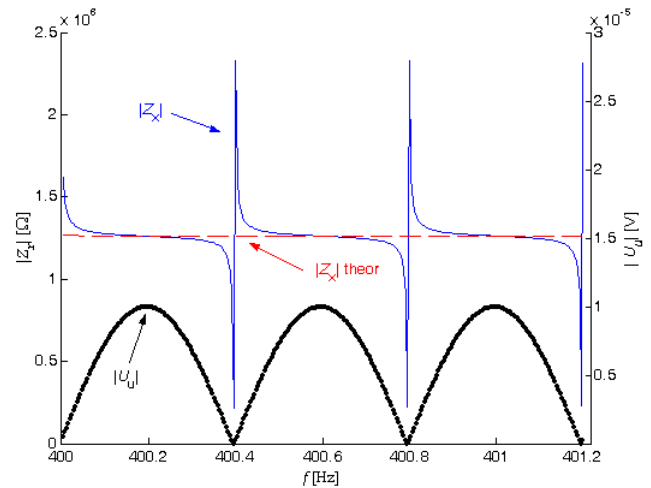

Figure 5. Illustration of the influence of minima of spectra of modulus of signals $|U_u|$ and $|U_i|$ (dotted black) on deviation of values of spectrum of impedance modulus (cont. blue) in relation to theoretical value (dashed red)

Due to this, it was decided to omit lines near the minimum of the $\sin(x)/x$ function and to calculate values of impedance for frequencies at which the function reaches local maxima (in the middle between minima), so for lines $k = (m+0.5) \cdot T_{\text{acq}}/t_{\text{imp}}$ (150, 250, 350...). This procedure decreases the number of frequencies for which the spectrum is calculated, especially for higher frequencies (in the example it is 50000 instead of 5000000), which gives the number of frequencies much greater than required to reconstruct the spectrum (a few tens of frequency points are necessary).

The used method of frequency selection meaningfully decreased the error of impedance spectrum determination in the frequency range up to 100 Hz. For the higher frequencies the accuracy is not satisfying, because the capacitance C_c with resistor R_o limiting the current create a voltage divider, attenuating amplitudes of spectral lines of voltage signal $|U_u|$ when the frequency becomes higher (Fig. 4). Because of this, for frequencies from 100 Hz up to 1 MHz the impedance spectrum is obtained with point by point impedance spectroscopy, using sinusoidal excitation. Using DFT to determine orthogonal parts of measurement signals [8], the impedance measurement time in this frequency range equals to 10 ms and is fully acceptable.

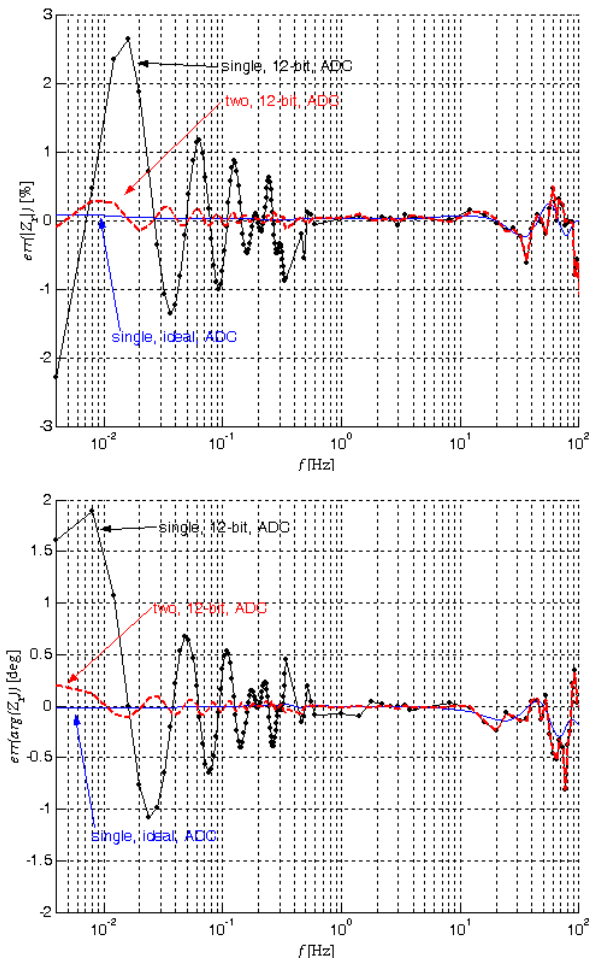

Figure 6. Impedance modulus and argument error in case of the use for sampling $u_i(t)$ one or two 12-bit ADCs

The concept of excitation of the measurement object first with harmonic signals and then with a square pulse to obtain the impedance spectrum in a wide frequency range (1 mHz – 1 MHz), requires to use fast AD converters (max. conversion time 100 ns) for sampling harmonic signals and the response in the time domain. So in the next stage of simulation 12-bit bipolar ADCs satisfying the given assumption were used. In Fig. 6 the error of impedance modulus and argument is shown in case of sampling signal $u_i(t)$ with a single 12-bit ADC and with two ADCs working in parallel according to the rule presented in Fig. 2.

Figure 6 proves that the 12-bit resolution of the ADC is not enough to sample signal $u_i(t)$, when the current flowing through the measured impedance Z_x decreases to zero (samples in 7-th and 8-th segment of the acquisition influence the accuracy of calculation of the impedance spectrum in the low frequency range). Both requirements: short conversion time and higher resolution of the converter were assured by the use of two 12-bit converters working in parallel. This solution assures small errors (Fig. 6) of determination of the impedance spectrum in the low frequency range.

IV. ALGORITHM OF THE MEASUREMENT PROCESS

The algorithm of the measurement process (Fig. 7) was developed and implemented in the realized impedance analyzer (Fig. 2). The measurement process starts when the set of required measurement points sorted from the highest to the lowest is written to the analyzer's memory. The process consists of two main parts differing in the method of impedance spectrum determination: for high frequencies (from 1 MHz down to 100 Hz) and low frequencies (below 100 Hz).

In the high frequency range, a sinusoidal signal is generated to excite the object. On the basis of two sets of samples of voltages u_i and u_u , using DFT transformation, the orthogonal parts of the measurement signals are determined. In the first stage of the algorithm, the correct measurement range is selected. In order to do this, the required amplitude and frequency of the measurement signal are programmed and then the value of the range resistor is increased (or decreased) to assure that the value of the signal u_i is in the specified range (U_g^L, U_g^H), given by the ADC range.

In the second stage of the algorithm, a correction of the amplitude set coarsely in stage 1 is performed. The amplitude is measured and, after calculation taking into account the existing voltage divider, the correction is applied if necessary. In the last stage, the real and imaginary parts of the impedance are calculated at the measurement frequency $f_{\text{meas}}(n)$. The presented process is repeated for the next frequency $(n+1)$ from the set of the given measurement frequencies. The last measurement cycle in the high frequency range takes place at the measurement frequency of 100 Hz.

In order to determine the impedance spectrum in the low frequency range (below 100 Hz) a square pulse is used as an excitation signal. The algorithm of the measurement process consists of automatic measurement range selection, generation of the excitation pulse with optimal duration time and response sampling with adequate frequencies in each sampling segment. This part of the algorithm is realized in three steps.

measurements was performed for a square pulse with amplitude 1 V and duration time $\tau_{imp} = 2.5$ s and 1 s.

When comparing the presented graphs (Fig. 8) obtained from measurements with those obtained from simulations (Fig. 6 $\tau_{imp} = 2.5$ s) a serious increase of errors can be noticed for frequencies above 20 Hz. It means that the proposed selection method of frequencies of the impedance spectrum in the range up to 100 Hz, is much less effective in real-life than in simulation. Shortening the excitation pulse duration ($\tau_{imp} = 1$ s) significantly decreases the error for frequencies above 10 Hz, but the error increases in the low frequency range of the spectrum. This leads to the conclusion that a correctly determined pulse duration forms a compromise for errors in the low and the high frequency range of the spectrum determined using continuous Fourier transformation.

The developed method is dedicated for portable devices performing anticorrosion coatings diagnostics on objects directly in the field, so the relative error of the impedance modulus at the level of a few percent and the absolute error of the argument at the level of a few degrees is fully acceptable. The main profit of the used method is meaningful shortening of the measurement time. For the tested object, classical spectroscopy takes more than 0.5 hour for the frequency range of 10 mHz – 100 Hz using 3 points per decade (in 1-2-5 steps) and for the proposed method it takes only a few minutes.

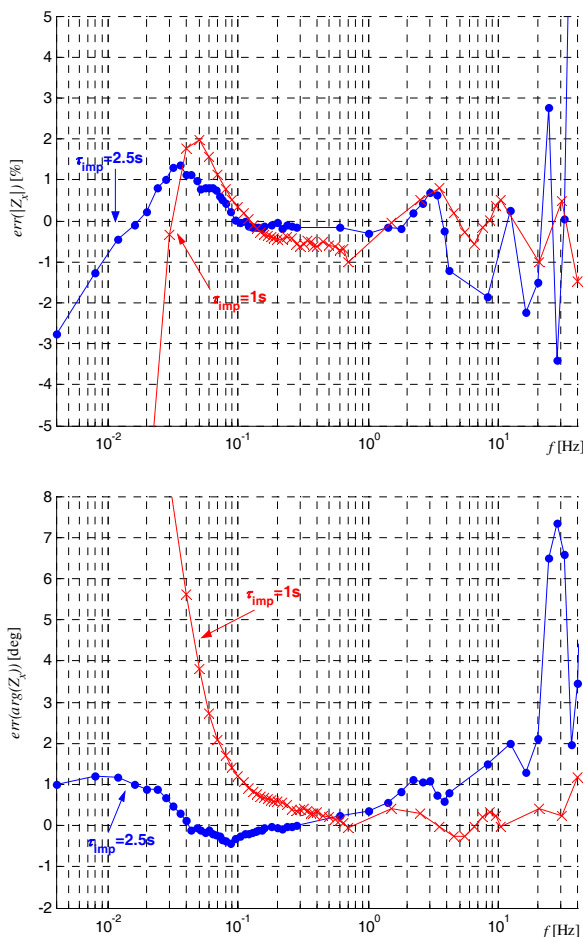

Figure 8. Impedance modulus and argument error for test object

VI. CONCLUSIONS

A method for fast high-impedance spectroscopy of anticorrosion coatings designed for portable devices realizing diagnostics of coatings in the field was developed. It shortens the measurement time of the impedance spectrum (in the frequency range of 1 mHz ÷ 1 MHz) to a few minutes. The method uses harmonic signals to measure impedance to determine the spectrum above 100 Hz and a square pulse in the low frequency range. To calculate the impedance spectrum, DSP algorithms were used adequate to the excitation signal: in the high frequency range - DFT, and in the low frequency range continuous Fourier transformation with selected sampling frequency in 8 acquisition segments, dependent on pulse duration time.

As a result of the performed simulation tests for a 4-element equivalent circuit of an anticorrosion coating, the relative error of modulus does not exceed $\pm 1\%$ and the absolute error of impedance argument $\pm 0.5^\circ$, respectively, in case of the proposed solution with two 12-bit ADCs working in parallel. During experimental verification of the method in the realized measurement system, the measurement errors have increased by a few times (in the range up to 20 Hz: $\pm 2\%$ and $\pm 1^\circ$ respectively). The obtained accuracy is acceptable in case of measurements performed in the field. The main advantage of the proposed method is meaningful shortening of the measurement time when compared with classical impedance spectroscopy. For the tested object, the measurement time was shortened from ca. 31 min. in case of a set consisting of Impedance Interface 1294 and Frequency Response Analyzer 1255 from Solartron to ca. 3 min., what is very important for measurements performed directly in the field.

REFERENCES

- [1] M. O'Donoghue, R. Garrett, V. Datta, P. Roberts and T. Aben, "Electrochemical Impedance Spectroscopy: Testing Coatings for Rapid Immersion Service", Materials Performance, NACE International, September 2003, pp. 36-41
- [2] E. Angelini, A. Carullo, S. Corbellini, F. Ferraris, V. Gallone, S. Grassini, M. Parvis and A. Vallan, "Handheld-impedance-measurement system with seven-decade capability and potentiostatic function" IEEE Trans. On Instrumentation and Measuremnt, vol. 55, No. 2, April 2006, pp. 436-441.
- [3] E. Barsoukov Sang Hyo Ryo and H. Lee, "A novel impedance spectrometer based on carrier function Laplace-transform of the response to arbitrary excitation" in J. of Electroanalytical Chemistry, vol. 536 (2002), pp. 109-122.
- [4] A. Mejia-Aguilar and R. Pallas-Areny, "Electrical impedance measurement using pulse excitation" in Proc. Of 16th IMEKO TC4 Symposium, September 22-24, 2008, Florence, Italy, pp. 567-572.
- [5] S. Park and J. Yoo, "Apparatus and method for measuring electrochemical impedance at high speed", United States Patent No. 6339334, Jan. 15, 2002.
- [6] C. Yoon, Y. Barsoukov, and J-H. Kim, "Laplace transform spectrometer and its measurement method", United States Patent No. 6687631, Feb. 3, 2004.
- [7] Cui Lu and Yan Peiyu, "An algorithm of galvanostatic pulse method to determine the corrosion status of reinforcement in concrete", Corrosion Science, vol. 42 (2000), pp. 675-686.
- [8] J. Hoja and G. Lentka, "Virtual instrument using bilinear transformation for parameter identification of high impedance objects", Meas. Sci. Tech., vol. 14, No. 5, pp. 633-642, May 2003