

This author accepted manuscript is deposited under a Creative Commons Attribution Non-commercial 4.0 International (CC BY-NC) licence. This means that anyone may distribute, adapt, and build upon the work for non-commercial purposes, subject to full attribution. If you wish to use this manuscript for commercial purposes, please visit Marketplace.

Postprint of: Smulko J., Trawka M., Granqvist C., Ionescu R., Annanouch F., Llobet E., Kish L., New approaches for improving selectivity and sensitivity of resistive gas sensors: a review, *Sensor Review*, Vol. 35, iss. 4 (2015), pp. 340-347, DOI: [10.1108/SR-12-2014-0747](https://doi.org/10.1108/SR-12-2014-0747)

New approaches for improving selectivity and sensitivity of resistive gas sensors: a review

Janusz Smulko, Maciej Trawka

Faculty of Electronics, Telecommunications and Informatics
Gdansk University of Technology, Gdańsk, Poland

Claes G. Granqvist

Department of Engineering Sciences
The Ångström Laboratory, Uppsala University, Uppsala, Sweden

Radu Ionescu, Fatima E. Annanouch, Eduard Llobet

ETSE-DEEEA, Department of Electronics

Rovira i Virgili University, Tarragona, Spain, and

Laszlo B. Kish

Department of Electrical Engineering

Texas A&M University

College Station, USA

Purpose – The aim of the paper is to present methods of improving selectivity and sensitivity of resistance gas sensors.

Design/methodology/approach – We compare various methods of improving gas sensing by the temperature modulation, the UV irradiation or fluctuation enhanced sensing. We analyze low-frequency resistance fluctuations in commercial Taguchi gas sensors and the recently developed WO₃ gas sensing layers, exhibiting a photo-catalytic effect.

Findings – The efficiency of using low frequency fluctuations to improve the gas detection selectivity and sensitivity was confirmed by numerous experimental studies in commercial and prototype gas sensors.

Research limitations/implications – A more advanced measurement setup is required to record noise data but reduces the number of gas sensors necessary for identifying the investigated gas mixtures.

Practical implications – Fluctuation enhanced sensing can reduce the energy consumption of gas detection systems and assures better detection results.

Originality/value – A thorough comparison of various gas sensing methods in resistance gas sensors was presented and supported by exemplary practical applications.

Keywords Gas sensors, Noise, Low-frequency noise, Detection methods, Photo-catalytic effect

Paper type Research paper

1. Introduction

Resistive gas sensors—also known as Taguchi gas sensors—are very popular as a consequence of their reasonable price and good durability (Sberveglieri, 1995). However, their selectivity and sensitivity are limited, and these deficiencies serve as the main driving force to develop new materials and methods for the superior gas detection. Taguchi gas sensors comprise a porous semiconductor layer (e.g., SnO₂, WO₃, TiO₂, ZnO) which starts to be gas sensitive at an elevated temperature, up to a few hundred °C (Fig. 1). This means that the sensors can be used to analyze even exhaust gases, but they have to consume energy for heating. Therefore, it is important to propose new methods which are able to improve the state-of-the-art in gas sensing.

There are numerous papers focused on optimizing parameters of metal oxides in order to enhance their selectivity and sensitivity (Li *et al.*, 1999; Franke *et al.*, 2006; Korotcenkov, 2005; Hyodo *et al.*, 2003; Yamazoe *et al.*, 1983; Heszler *et al.*, 2007). Thus, it was established that a vital improvement can be reached via controlling the size and the

shape of the gas sensor's oxide grains (Li *et al.*, 1999; Franke *et al.*, 2006) or by introducing catalytically active additives in the sensing layer via doping or a surface functionalization (Korotcenkov, 2005; Hyodo *et al.*, 2003; Yamazoe *et al.*, 1983; Heszler *et al.*, 2007). The results of these improvements are still far from satisfactory, and therefore it is of great interest to consider new methods for advancing the gas detection.

The gas detection efficiency can be enhanced not only by a technological development of the sensors but also by new measurement methods and signal processing. Recently, experimental studies confirmed that low-frequency, colored resistance fluctuations, generated within the gas sensors, can be utilized to improve their selectivity and sensitivity (Kish *et al.*, 2000; Vidybida, 2003; Ederth *et al.*, 2006; Kotarski *et al.*, 2009). It is well known that the $1/f$ noise is intense in porous materials and depends on their surface treatment (Stadler *et al.*, 2014; Granqvist *et al.*, 2008). It is also clear that similar phenomena can be used to determine the ambient atmosphere for gas sensors. The low frequency noise can be characterized by various statistical functions (e.g. the power spectral density or the probability distribution); they are more informative than the DC resistance which gives nothing but an individual number for the sensor.

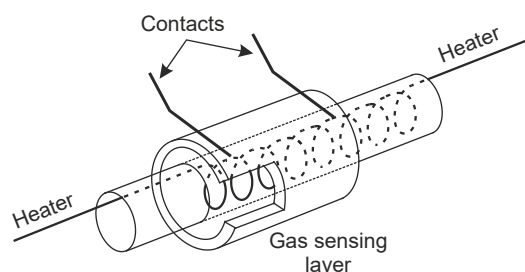

Fig. 1. The structure of a resistive gas sensor

Another method, which can be easily implemented to improve the gas detection, utilizes the temperature modulation of the gas sensing layer. Processes connected with the gas molecule adsorption and desorption depend on temperature and are responsible for a drop in the sensitivity at low and high operating temperatures (Morrison, 1987). The competition between adsorption and desorption processes determines the temperature of the maximum sensitivity and its decrease at temperature changes. This means that different temperature profiles should be observed for different gases and utilized for selectively recognizing them, as has been confirmed experimentally (Yamazoe *et al.*, 2011; Zaretskiy *et al.*, 2012). Moreover, a change of the gas sensitivity versus temperature ratio can be utilized to preserve the information about the ambient atmosphere within the gas sensor by its cooling in the investigated environment and “freezing” the gas molecules within the gas sensing layer for a further analysis under laboratory conditions at an elevated temperature. This technique is referred to as the “sample-and-hold” and can be used together with fluctuation enhanced sensing (Ayhan *et al.*, 2013).

Adsorption and desorption processes are accelerated when the gas sensing layer operates at an elevated temperature, typically above 150°C. However, such conditions limit possible sensor applications and furthermore increase the energy consumption. There is an experimental evidence that some gas sensing materials exhibit a photo-catalytic effect, and their sensitivity to various gases can be modulated by the UV irradiation (Comini *et al.*, 2000; Mishra *et al.*, 2004; Zaretskiy *et al.*, 2012; Chen *et al.*, 2012; Ayhan *et al.*, 2013). This effect has been observed, even at the room temperature, and resulted in a better sensitivity to the selected gases. We can expect that similar effects of the UV irradiation can be observed for the DC resistance and low-frequency noise as well. Preliminary experimental results confirmed the photo-catalytic effect for a very thin TiO₂ gas sensing layer, but its very high resistance limited practical applications (Topalian *et al.*, 2007). The resistance noise induced by the UV irradiation could potentially be a very sensitive tool, because the generated noise should be sensitive to the wavelength of the applied irradiation. Thus a combination of different wavelengths of the light sources could result in the superior gas selectivity as compared with other methods.

The mentioned sensing methods can provide an additional information about the ambient atmosphere of the gas sensor than what is possible with the DC resistance only. This information has to be properly processed to get satisfactory detection results by applying various algorithms. Usually, different gases are detected by applying a sensor array (electronic nose) and a processing array for DC resistances using pattern recognition methods (Machado *et al.*,

2005; Distant *et al.*, 2012; Kalinowski *et al.*, 2013). We will present a number of selected detection methods which can guarantee that the gathered noise data and dynamic changes of the DC resistance at a temperature change limit the number of sensors necessary to record the selected gases.

2. Fluctuation-enhanced gas sensing

Resistive gas sensors exhibit an intense $1/f$ noise component, which overwhelms the white noise up to tens of kHz at least. The low-frequency noise is generated by fluctuations of the potential barrier between the grains (Fig. 2). The barrier depends on adsorption and desorption processes, and therefore its fluctuations can be selective to the ambient atmosphere of the gas sensor and its temperature. There is an experimental evidence that the $1/f$ noise increases when the grains are smaller. Additionally, noise changes are much more sensitive than changes in the DC resistance, and the sensitivity increases further when the grains of the investigated gas sensing layer decrease (Ederth *et al.*, 2006).

The low-frequency noise generated within the porous gas sensing layer can be observed as voltage or current fluctuations across/through the gas sensor biased by a constant voltage U or current I in accordance with the Hooge formula (Hooge *et al.*, 1981):

$$\frac{S_u(f)}{U^2} = \frac{S_i(f)}{I^2} = \frac{\alpha}{fnV_{eff}}, \tag{1}$$

where $S_u(f)$ and $S_i(f)$ are power spectral densities of voltage and current fluctuations observed across/through the biased gas sensor, respectively, α is the Hooge parameter which depends on the material of the gas sensing layer and the ambient atmosphere, n is the density of charge carriers involved in the noise generation within the gas sensing layer, and V_{eff} is the effective noise volume of the sensor determined by the grain boundary contacts. Thus, to get an information about the ambient atmosphere we have to estimate $S_u(f)/U^2$ or $S_i(f)/I^2$, which are independent of the sensor bias. Figure 3 shows examples of noise data observed in a commercial TGS 826 gas sensor. Typically, we observe the $1/f$ noise whose intensity depends on the ambient atmosphere. The power spectral density can change by as much as a few orders of magnitude and is characteristic for the investigated gas and its concentration.

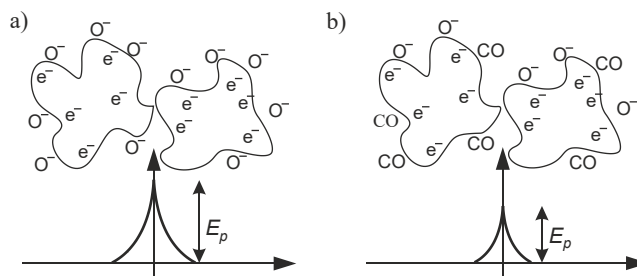

Fig. 2. The influence of the ambient atmosphere causing changes in the potential barrier E_p between the grains of the gas sensing layer: (a) in the presence of oxygen ions (O^-) and (b) displaced by carbon monoxide (CO) molecules

The observed $1/f$ noise can give a sufficient information to limit the number of sensors necessary to distinguish between the selected gases (e.g., ammonia and hydrogen sulfide), as presented by Kotarski and Smulko (2010). When a single gas sensor is applied, and one observes its low-frequency noise and DC resistance by measuring the DC voltage across the sensor (Fig. 4), it is possible to determine the gas concentration and detect gaseous species.

The power spectral density $S_u(f)$ observed at the output of the system depends on the ambient gas by a change of the normalized spectrum $S_u(f)/U^2$, and — independently — on the change of the sensor's DC resistance R_s and the driving resistance R_1 according to

$$S_u(f) = \frac{S_u(f)}{U^2} U^2 = \frac{S_u(f)}{U^2} U_0^2 \left(\frac{R_s}{R_1 + R_s} \right)^2. \tag{2}$$

When the sensor exhibits various changes of $S_u(f)/U^2$ in different gases, one can establish the type of gas and the DC resistance determines its concentration. Equation (2) can be used for detection only because it depends on the measurement setup (resistance R_1). The normalized power spectrum of the sensor resistance fluctuations $S_{R_s}(f)/R_s^2$ is independent from the measurement system and can be estimated from the product $S_u(f)/U^2$ as presented by Chang *et al.*, 2009. Figure 5 presents data observed for two gases, ammonia and hydrogen sulfide, in a commercial gas sensor TGS 826 (Kotarski *et al.*, 2010). The presence of hydrogen sulfide increases the power spectral density, whereas ammonia decreases it. Thus, using a single sensor one can detect which gas is present by estimating $S_u(f)$ within the selected bandwidth and determining its changes by comparing them with measurements in the air.

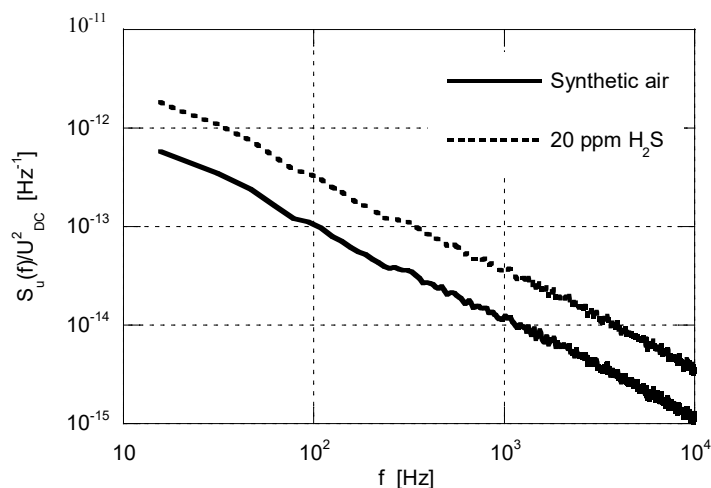

Fig. 3. The power spectral density $S_u(f)$ of voltage fluctuations across a commercial TGS 826 gas sensor, normalized to the square of the DC bias voltage U . The data were taken in the ambient atmosphere of hydrogen sulfide (H_2S) diluted in a synthetic air at different concentrations. The noise is observed within a few decades of the frequency f

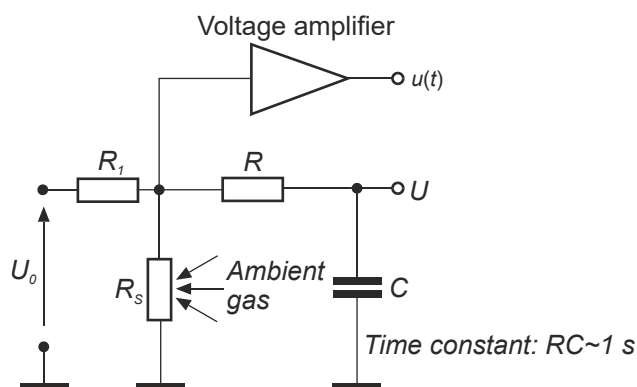

Fig. 4. The measurement set-up for the power spectral density $S_u(f)$ of voltage fluctuations $u(t)$ across a gas sensor having a DC resistance R_s and being biased by a DC voltage U

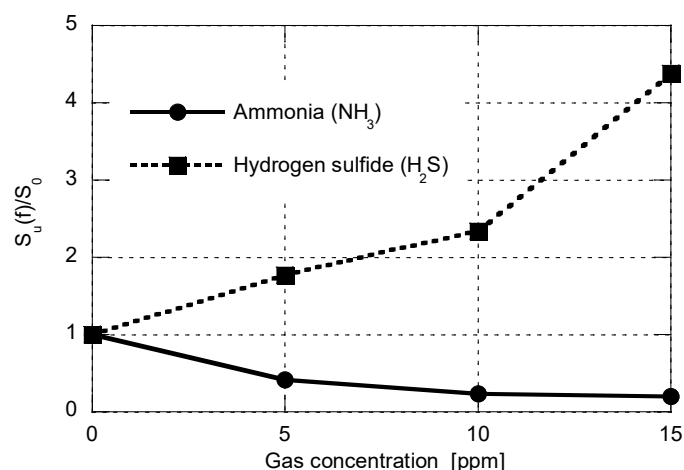

Fig. 5. The normalized power spectral density $S_u(f)$ of voltage fluctuations across the sensor at 1kHz for a commercial TGS 826 sensor in various gases and concentrations. The sensor was serially connected with a resistor $R_l = 11 \text{ k}\Omega$ and biased by a stabilized voltage source U_0 (cf. Fig. 4)

Other methods for the gas detection by using fluctuation enhanced gas sensing require more advanced statistical parameters (e.g. bispectrum) in order to expose a non-Gaussian component, characteristic for various gases (Smulko *et al.*, 2001). A bispectrum function can measure the intensity of that component but requires more data to be estimated than those needed for the power spectral density. Cross-level images of the bispectrum can be used to determine the presence of different gases (Schmera *et al.*, 2010). There is an evidence that the non-Gaussian component is more intense with gas sensors comprising smaller grains (Smulko *et al.*, 2004). The bispectrum function is often much more informative than the power spectral density only, but the requirements of a longer averaging time and slower noise sampling limit its practical application.

3. Gas sensor temperature modulation

Features of resistive gas sensors depend strongly on their working temperature, and this fact can be used to gather more information about the ambient atmosphere in order to improve the sensitivity and selectivity. Typically, one can use pulse heating to clean the gas sensing layer by removing adsorbed molecules. When the intensity of the heating pulse is carefully selected, one can observe dynamic changes of the DC resistance R_S with a characteristic shape determined by the composition of the ambient atmosphere (Fig. 6). It should be underlined that a drop of the heating voltage from 5 to 4.7 V results in a significant change of the DC resistance but almost no change of $S_u(f)/U^2$. Thus, in order to improve the gas detection one should consider the shape of the DC resistance changes, or selected parameters describing them, such as the maximum and the derivative at a rise and a drop. Results analogous to those in Fig. 6 were observed when the heating voltage was increased; then the DC resistance dropped and exhibited a local minimum mirroring the shape of the time dependence shown in Fig. 6. Time constants of the DC resistance modulation depend on the gas sensors, their ambient atmosphere, and the temperature alteration. Thus, in some prototype gas sensors with very thin gas sensing layers, one can observe a much stronger change of the DC resistance and the absence of a peak structure (Fig. 7), which is a consequence of a smaller thermal inertia than that for a commercial sensor (Fig. 6) with a much greater volume (Fig. 1).



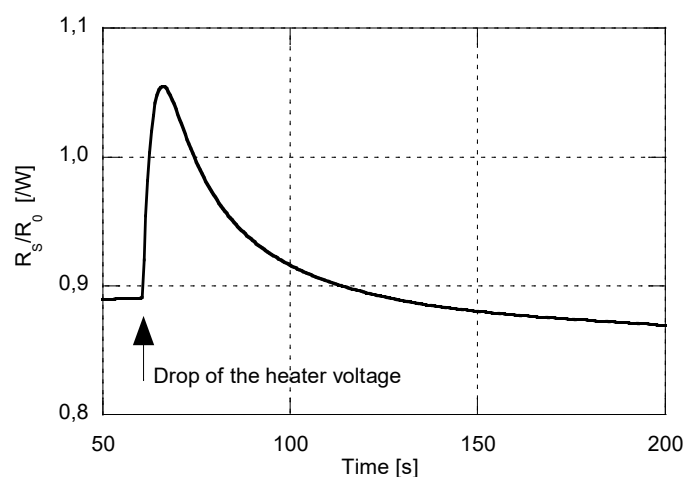

Fig. 6. The time-dependent gas sensor DC resistance R_S at an abrupt drop of the heating voltage from 5 to 4.7 V. A commercial gas sensor (TGS 2600) was placed in the ambient atmosphere of combustible gases (C_2H_6 , C_3H_8 , $n-C_4H_{10}$, C_4H_{10}); R_S was normalized to the sensor's DC resistance R_0 observed in a synthetic air

It is worth mentioning that the temperature modulation can lead to very interesting and new applications when the heated gas sensor is exposed to an unknown gas mixture and subsequently cooled. The gas molecules will then be trapped inside the porous gas sensing layer as a result of less intense adsorption/desorption processes and preserved for a further analysis under laboratory conditions (Ayhan *et al.*, 2013). Moreover, one can expect that the resistance noise in the gas sensing structure could be observed and used for the gas detection even at temperatures lower than those typically employed for the gas sensor. This means that various temperatures could be applied to establish an adsorption–desorption profile of the explored atmosphere and providing an improved gas detection.

4. Light-induced gas sensing

The light activation for gas sensing applications has been reported for various oxide layers (e.g., ZnO, WO₃, SnO₂, TiO₂) in literature (Ayhan *et al.*, 2000; Mishra *et al.*, 2004; Topalian *et al.*, 2007; Chen *et al.*, 2012). The UV light is applied to assure a sufficient energy for acceleration of adsorption/desorption processes. Usually the same effect can be obtained by heating the gas sensing layer. This means that using the UV light results in a lower energy consumption and ability to work at much lower temperatures. The second fact opens new applications for resistive gas sensors (e.g. detecting combustible gases or explosives). Additionally, one can expect that the UV light reduces the measurement time and can be used to clean gas sensors after poisoning (Comini *et al.*, 2000).

Examples of data recorded with an Au-nanoparticle-decorated WO₃-nanowire gas sensing layer are presented in Fig. 7 (Vallejos *et al.*, 2013), which compares the change of the sensor's DC resistance, induced by an abrupt increase of the heating voltage, with that caused by the UV irradiation using a T5F UV diode emitting radiation at a wavelength of 365 nm. The diode was placed about 5 mm from the surface of the sensor layer, and its DC current I_d was controlled up to the maximum value of 20 mA.

One can conclude that additional data on the ambient atmosphere can result from the application of an abrupt temperature change as well as from the UV irradiation. The shape of the recorded curve depends on the sensor's ambient atmosphere, as was observed for a synthetic air (Fig. 7) and ethanol (Fig. 8). Data collected by using the UV light and temperature modulation are rather similar, at least for the presented results, but it should be underscored that the UV light yields a lower energy consumption than that necessary for the temperature modulation (the effect on the sensor's DC resistance change can be observed even at low diode currents I_d ; *cf.* Fig. 8). Additionally, using the UV light one can detect gases at much lower temperatures, which is a very attractive feature. One can expect that the UV irradiation will increase the usefulness of fluctuation enhanced sensing, because the $1/f$ noise might depend strongly on the wavelength

of the applied UV light and therefore should provide more information about the ambient gas than the temperature modulation alone.

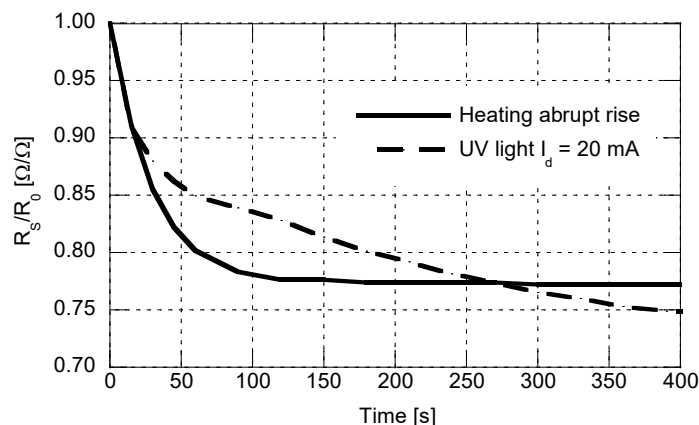

Fig. 7. The relative change of the DC resistance R_S for a WO_3 gas sensing layer at an abrupt rise of the heating voltage from 1.5 to 1.8 V, corresponding to the temperature change between 100 and 120°C (solid curve), and by the UV irradiation (dashed curve). R_0 denotes the resistance in a synthetic air and at the heating voltage of 1.5 V, and I_d is the UV diode current

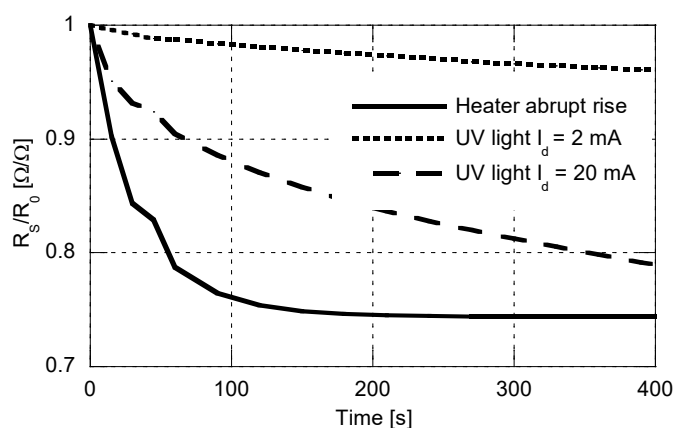

Fig. 8. The relative change of the DC resistance R_S for a WO_3 gas sensing layer at an abrupt rise of the heating voltage from 1.5 to 1.8 V, corresponding to the temperature change between 100 and 120°C (solid line), and by the UV irradiation at the shown values of the UV LED current. Data were taken in 200 ppm of ethanol. R_0 denotes the resistance in 200 ppm of ethanol at the heating voltage of 1.5 V

5. Detection algorithms

This paper has demonstrated that gas sensing can in some cases be improved by very simple methods, and different gases can be detected by a single gas sensor by using noise measurements (*cf.* Fig. 5). In general, the same detection algorithms can be used for gas sensing as for other detection methods, e.g. chemometric techniques as presented by Geladi *et al.*, (2005) when the input data are vectors. A set of DC resistances, the power spectral density of voltage fluctuations across the sensor (Fig. 3), and a dynamic change of the DC resistance in selected time intervals (Fig. 6) can be treated as vectors. Such data can be analyzed by a principal component analysis (PCA), which utilizes the linear and orthogonal data transformation into a new set of linearly uncorrelated variables, referred to as “principal components”. This method requires algebraic computations to perform the necessary transforms in order to establish the most informative components. The method is commonly used in gas sensing applications for the gas detection or for the gas

concentration prediction. A more advanced method employs a support vector machine (SVM) algorithm, which is a nonlinear version of the PCA (Distante *et al.*, 2003; Kalinowski *et al.*, 2013). The latter method gives even better results, because gas sensors respond to various gases in a nonlinear manner. Both PCA and SVM can be applied to detect the presence of the selected gases which exceed threshold concentrations and to establish their concentration using a regression model.

The data used for the gas detection (e.g. the power spectral density) are vectors whose adjoining elements are correlated, and therefore methods such as PCA or SVM have to reduce abundant data. Therefore, other methods which might have similar detection efficiency but require much less intense computations, can be of interest. Such methods use selected parameters of the estimated functions. In the case of the power spectral density, one can use its intensity and slope within a selected bandwidth (Chang *et al.*, 2009). This method requires a limited computation and can create a reduced set of data for further processing by a more computationally demanding method, e.g. an SVM algorithm (Turner and Magan, 2004).

In general, the algorithms have to be adjusted for the case when a few volatile components have to be detected and additionally some specific substances exist in the ambient atmosphere and conceal the effects caused by the chemicals of interest. A good example is the identification of chemical compounds in a human breath, which can be characteristic for some diseases (Machado *et al.*, 2005).

6. Conclusions

Various methods for improving the selectivity and sensitivity of resistive gas sensors were presented. The proposed methods can be applied to prepare more advanced measurement set-ups than those commonly used today. The same techniques can also be used to improve new gas sensing materials. A combined method of fluctuation enhanced sensing and the UV light modulation might be the most promising method to reach the maximum sensitivity and selectivity at a limited cost, as also supposed by other authors (Lay-Ekuakille *et al.*, 2014).

Table 1. Pros and cons of the considered gas sensing methods

Method	Advantages	Disadvantages
Resistance	Easy measurements; can be modulated by temperature change or UV light when photo-catalysis is present.	Gives a single number only; requires additional sensors to detect composition of gas mixtures.
Fluctuation enhanced sensing	Up to a few hundred times more sensitive than DC resistance; gives reduction of consumed energy.	More complicated measurements and estimation method; longer averaging time.

It is difficult to compare the efficiency of fluctuation enhanced sensing with the gas detection using DC resistance measurements only because both methods establish a different information about the sensor's ambient atmosphere. The main features for comparing both methods are collected in Table 1. We can conclude in general that fluctuation enhanced sensing is more sensitive and gives an additional information when compared with DC resistance measurements only. Additionally, differences between the methods are more visible when the sensors are comprised of very small grains. Then the gas sensors respond to gas changes in a faster way, and the $1/f$ noise predominates even up to tens of kHz (Ederth *et al.*, 2006; Smulko *et al.*, 2004; Kwan *et al.*, 2008).

The presented new approaches to gas sensing using resistance sensors should facilitate the introduction of new applications by enabling the gas detection at different temperatures than previously assumed or determining the composition of the gas mixture with a reduced number of the applied sensors.

Acknowledgment

This research was partially financed by the National Science Center, Poland, number of the decision: DEC-2012/06/M/ST7/00444 "Detection of gases by means of nanotechnological resistance sensors". CGG's work was



supported by the European Research Council under the European Community's Seventh Framework Program (FP7/2007–2013)/ERC Grant Agreement No. 267234 ("GRINDOOR"), by the Spanish Government under grant no. TEC2012-32420 and the Catalan Government under grant 2014 SGR 1267. R.I. acknowledges a 'Ramón y Cajal' fellowship from the Ministry of Economy and Competiveness (MINECO), Spain. E.L. is supported by the Catalan Institution for Research and Advanced Studies via the ICREA Academia Award. The paper is an updated and enriched version of the presentation given at the 8th International Conference on Sensing Technology, Liverpool, UK.

References

- Ayhan, B., Kwan, C., Zhou, J., Kish, L.B., Benkstein, K.D., Rogers, P. H., and Semancik, S. (2013), "Fluctuation enhanced sensing (FES) with a nanostructured, semiconducting metal oxide film for gas detection and classification", *Sensors and Actuators B: Chemical*, Vol. 188, pp. 651-660.
- Chang, H.C., Kish, L.B., King, M.D. and Kwan, C. (2009), "Fluctuation-enhanced sensing of bacterium odors", *Sensors and Actuators B: Chemical*, Vol 142, pp. 429-434.
- Chen, H., Liu, Y., Xie, C., Wu, J., Zeng, D. and Liao, Y. (2012), "A comparative study on UV light activated porous TiO₂ and ZnO film sensors for gas sensing at room temperature", *Ceramics International*, Vol. 38, pp. 503-509.
- Comini, E., Cristalli, A., Faglia, G. and Sberveglieri, G. (2000), "Light enhanced gas sensing properties of indium oxide and tin dioxide sensors", *Sensors and Actuators B: Chemical*, Vol 65, pp. 260-263.
- Distante, C., Ancona, N. and Siciliano, P. (2003), "Support vector machines for olfactory signals recognition", *Sensors and Actuators B: Chemical*, Vol. 88, pp. 30-39.
- Ederth, J., Smulko, J., Kish, L.B., Heszler, P. and Granqvist, C.G. (2006), "Comparison of classical and fluctuation-enhanced gas sensing with Pd_xWO₃ nanoparticle films", *Sensors and Actuators B: Chemical*, Vol. 113, pp. 310-315.
- Franke, M. E. T., Koplin, J. and Simon U. (2006), "Metal and metal oxide nanoparticles in chemiresistors: Does the nanoscale matter?", *Small*, Vol. 2, pp. 36-50.
- Geladi, P. and Esbensen, K. (2005), "The start and early history of chemometrics: Selected interviews. Part 1", *Journal of Chemometrics*, Vol. 4, pp. 337-354.
- Granqvist, C.G., Green, S., Jonson, E.K., Marsal, R., Niklasson, G.A., Granqvist, C. G., Green, S., Jonson, E. K., Marsal, R., Niklasson, G. A., Roos, A. and Kish, L. B. (2008), "Electrochromic foil-based devices: Optical transmittance and modulation range, effect of ultraviolet irradiation, and quality assessment by 1/f current noise", *Thin Solid Films*, Vol. 516, pp. 5921-5926.
- Heszler, P., Ionescu, R., Llobet, E., Reyes, L.F., Smulko, J., Kish, L. B. and Granqvist, C. G. (2007), "On the selectivity of nanostructured semiconductor gas sensors", *Physica Status Solidi B*, Vol. 244, pp. 4331-4335.
- Hooge, F.N., Kleinpenning, T.G.M. and Vandamme, L.K.J. (1981), "Experimental studies on 1/f noise", *Reports on Progress in Physics*, Vol. 44, pp. 479-532.
- Hyodo, T., Abe, S., Shimizu, Y. and Egashira, M. (2003), "Gas-sensing properties of ordered mesoporous SnO₂ and effects of coatings thereof", *Sensors and Actuators B: Chemical*, Vol. 93, pp. 590-600.
- Kalinowski, P., Woźniak, Ł., Strzelczyk, A., Jasinski, P. and Jasinski, G. (2013), "Efficiency of linear and non-linear classifiers for gas identification from electrocatalytic gas sensor", *Metrology and Measurement Systems*, Vol. 20, pp. 501-512.
- Kish, L.B., Vajtai, R. and Granqvist, C.G. (2000), "Extracting information from noise spectra of chemical sensors: Single sensor electronic noses and tongues", *Sensors and Actuators B: Chemical*, Vol. 71, pp. 55-59.
- Korotcenkov, G. (2005), "Gas response control through structural and chemical modifications of metal oxide films: State of the art and approaches", *Sensors and Actuators B: Chemical*, Vol. 107, pp. 209-232.



- Kotarski, M. and Smulko, J. (2009), "Noise measurement setups for fluctuations enhanced gas sensing", *Metrology and Measurement Systems*, Vol. 16, pp. 457-464.
- Kotarski, M. and Smulko, J. (2010), "Hazardous gases detection by fluctuation-enhanced gas sensing", *Fluctuation and Noise Letters*, Vol. 9, pp. 359-371.
- Kwan, C., Schmera, G., Smulko, J., Kish, L.B., Heszler, P. and Granqvist, C.G. (2008), "Advanced agent identification with fluctuation-enhanced sensing", *IEEE Sensors Journal*, Vol. 8, pp. 706-713.
- Lay-Ekuakille, A., Vergallo, P., Morello, R. and De Capua, C. (2014), "Indoor air pollution system based on LED technology", *Measurement*, Vol. 47, pp.749-755.
- Li, G.J., Zhang, X.H., Kawi, S. (1999), "Relationships between sensitivity, catalytic activity, and surface areas of SnO₂ gas sensors", *Sensors and Actuators B: Chemical*, Vol. 60, pp. 64-70.
- Machado, R.F., Laskowski, D., Deffenderfer, O., Burch, T., Zheng, S., Mazzone, P. J. and Erzurum, S. C. (2005) "Detection of lung cancer by sensor array analyses of exhaled breath", *American Journal of Respiratory and Critical Care Medicine*, Vol. 171, pp. 1286-1291.
- Mishra, S., Ghanshyam, C, Ram, N., Bajpai, R.P. and Bedi, R.K. (2004), "Detection mechanism of metal oxide gas sensor under UV radiation", *Sensors and Actuators B: Chemical*, Vol. 97, pp. 387-390.
- Morrison, S.R. (1987), "Selectivity in semiconductor gas sensors", *Sensors and Actuators*, Vol. 12, pp. 425-440.
- Sberveglieri, G. (1995), "Recent developments in semiconducting thin-film gas sensors", *Sensors and Actuators B: Chemical*, Vol. 23, pp. 103-109.
- Schmera, G., Kish, L.B. and Smulko, J. (2010), "Method of pattern generation for gas recognition", Patent USA, US7680607.
- Smulko, J., Ederth, J., Kish, L.B., Heszler, P. and Granqvist, C.G. (2004), "Higher-order spectra in nanoparticle gas sensors", *Fluctuation and Noise Letters*, Vol. 4, L597-L603.
- Smulko, J., Granqvist, C.G. and Kish, L.B. (2001), "On the statistical analysis of noise in chemical sensors and its application for sensing", *Fluctuation and Noise Letters*, Vol. 1, pp. L147-L153.
- Stadler, A.W., Zawislak, Z., Dziedzic, A. and Nowak, D. (2014), "Noise spectroscopy of resistive components at elevated temperature", *Metrology and Measurement Systems*, Vol. 21, pp. 15-26.
- Topalian, Z., Smulko, J., Niklasson, G.A. and Granqvist, C.G. (2007), "Resistance noise in TiO₂-based thin film gas sensors under ultraviolet irradiation", *Journal of Physics: Conference Series*, Vol. 76, 012056/1-012056/5.
- Turner, A.P. and Magan, N. (2004), "Electronic noses and disease diagnostics", *Nature Reviews Microbiology*, Vol. 2, pp. 161-166.
- Vallejos, S., Umek, P., Stoycheva, T., Annanouch, F., Llobet, E., Correig, X., De Marco, P., Bittencourt, C. and Blackman, C. (2013), "Single-step deposition of Au- and Pt-nanoparticle-functionalized tungsten oxide nanoneedles synthesized via aerosol-assisted CVD, and used for fabrication of selective gas microsensor arrays", *Advanced Functional Materials*, Vol. 23, pp. 1313-1322.
- Vidybida, A.K. (2003), "Adsorption-desorption noise can be used for improving selectivity", *Sensors and Actuators A: Physical*, Vol. 107, pp. 233-237.
- Yamazoe, N., Kurokawa, Y. and Selyama, T. (1983), "Effects of additives on semiconductor gas sensors", *Sensors and Actuators*, Vol. 4, pp. 283-289.
- Yamazoe, N. and Shimanoe, K. (2011), "Theoretical approach to the gas response of oxide semiconductor film devices under control of gas diffusion and reaction effects", *Sensors and Actuators B: Chemical*, Vol. 154, pp. 277-282.
- Zaretskiy, N.P., Menshikov, L.I., Vasiliev, A.A. (2012), "On the origin of sensing properties of the nanostructured layers of semiconducting metal oxide materials", *Sensors and Actuators B: Chemical*, Vol. 170, pp. 148-157.



About the authors

Janusz M. Smulko received his M.Sc., Ph.D. and D.Sc. degrees in electronics from Gdansk University of Technology, Poland, in 1989, 1996 and 2007, respectively. Since 2013 the Head of the Metrology and Optoelectronics Department of the Gdansk University of Technology. He had also conducted scientific research in short-term positions in Texas A&M University (2003), Uppsala University (2006/07), Massachusetts Institute of Technology (2011, 2013). As a researcher he focuses on applications of the $1/f$ noise for gas sensing and a reliability assessment of electronic components and structures, an influence of noise on the detection efficiency in Raman spectroscopy systems. He is a member of the Committee on Metrology and Scientific Instrumentation of the Polish Academy of Science and Editor-in-Chief of Metrology and Measurement Systems Journal. He is the author of more than 60 papers in international journals and the holder of 3 patents.

Maciej Pawel Trawka was born in Poland, 1988. He graduated in Electronics and Telecommunications from the Poznan University of Technology, Poland. He was employed as an Intern Student in Mentor Graphics Corporation, where developed the fastest, serial interface for VLSI system-on-chip testing. He is currently a PhD student at the Metrology and Optoelectronics Department, Gdansk University of Technology, Poland. His thesis is associated with nanoparticle gas sensors and new approaches of gas detection.

Radu Ionescu is 'Ramon y Cajal' Senior Researcher in the Department of Electronics, Electrical and Automatic Engineering from Rovira i Virgili University, Tarragona, Spain. He received his degree in Electrical Power Engineering from the Polytechnic University of Bucharest, Romania, in 1998, and his Ph.D. degree in Electronics Engineering from the Polytechnic University of Catalonia, Barcelona, Spain, in 2003. He was postdoctoral researcher at Rovira i Virgili University (4 years), experienced researcher (FP6 Marie Curie Transfer of Knowledge Actions) at Mediterranean University of Reggio Calabria, Italy (2 years), and EC Senior Researcher in the Department of Chemical Engineering from the Technion – Israel Institute of Technology, Haifa, Israel (2 years).

Eduard Llobet graduated in telecommunication engineering from the Universitat Politècnica de Catalunya (UPC) (Barcelona, Spain) in 1991, and received his PhD in 1997 from the same university. His thesis focused on the use of response dynamics to enhance the selectivity of metal oxide gas sensors. He is currently full professor of Electronic Technology at the Electronic Engineering Department of the Universitat Rovira i



Virgili (Tarragona, Spain). His main areas of interest are in the design and fabrication of nanostructured metal oxide and/or carbon nanotube gas sensors and in the application of intelligent systems to complex odor analysis. Since 2010 he has been the Director of the Research Centre on Engineering of Materials and Micro/Nanosystems (EMaS), a multi-disciplinary research platform that brings together experts in materials science, physicists, chemists and engineers with common interests in nanoelectronics, photonics, catalysis, energy and (bio)chemical sensing.

Fatima Ezahra Annanouch was born in Morocco, 1986. She graduated in Physics from the Moulay Ismail University in Meknes, Morocco and is currently a PhD student at the Electronic Engineering Department, University Rovira i Virgili, Tarragona, Spain. Her thesis is oriented towards the bottom-up integration of nanofibers in sensor Microsystems.

Laszlo B. Kish is full professor at the Department of Electrical and Computer Engineering of Texas A&M University. His main research interests are unidentified problems, particularly the laws, limits, and applications of stochastic fluctuations (noise). The applications, among others, include fluctuation-enhanced sensing; noise-based logic and computing; unconditionally secure communications; communications without emitted signals; secure computers and hardware. He was recipient of the Honorary Doctor title from Uppsala University, Sweden (2011) and from the University of Szeged, Hungary (2012); and the Doctor of Science title from the Hungarian Academy of Science (2001). He was awarded the year 2001 Benzelius Prize of the Royal Society of Science of Sweden for the invention of fluctuation-enhanced sensing and his related activity. In the search for scientific truth, with his coauthors, he successfully challenged Landauer's principle of memory erasure; the claim that quantum computers can dissipate less than general-purpose desktops; the hopes that twisted radio waves are feasible for long-range communications; the quantum $1/f$ noise model; and the belief that only quantum informatics can be unconditionally secure.

Claes G Granqvist is Senior Professor of Solid State Physics at the Angstrom Laboratory, Uppsala University, Sweden. During 1989-1993, he was Professor of Experimental Physics at Gothenburg University, Sweden. Much of Granqvist's research is concerned with materials—especially functional coatings—for energy efficiency and solar energy utilization in the built environment. Electrochromics-based and thermochromics-based “smart windows” with variable transmittance of visible light and solar energy are two examples. Other recent research topics include transparent electrical conductors and nanomaterials for gas sensing and for photo-catalytic purification of gases and fluids. Granqvist has published more than 800



scientific articles and about 25 books and conference proceedings. He has given more than 250 invited talks, mainly on energy related issues, and he has organized about 40 international conferences on that subject. Granqvist is a member of the Royal Swedish Academy of Sciences, the Royal Swedish Academy of Engineering Sciences, and Regia Societas Scientarium Upsalienses. Furthermore he is Fellow of the International Society of Optical Engineering (USA), Dr h.c. at Universidad Nacional de Ingeniería in Lima, Peru, and honorary member of the Materials Research Society of India. He has received several prizes and awards. Granqvist is one of the founders of ChromoGenics AB, a company with some 20 employees, for producing electrochromic foils.