

NOVEL APPLICATION OF DYNAMIC ELECTROCHEMICAL IMPEDANCE MONITORING TO A CATAPHORETIC COATING PROCESS

K. Darowicki, P. Ślepski, M. Szociński*

*Gdansk University of Technology, Chemical Faculty,
Department of Electrochemistry, Corrosion and Materials Engineering
11/12 G. Narutowicza Str., Gdańsk 80-233, POLAND*

Abstract

The paper presents a novel method of on-line impedance monitoring of cataphoretic coating application process. Utilization of dynamic electrochemical impedance spectroscopy (DEIS) overcame the fundamental problem connected with non-stationarity of the aforementioned coating deposition process, which eliminates classical impedance spectroscopy technique from a real-time description of cataphoresis. The paper illustrates selected examples of potentialities of DEIS regarding the characterization of the cataphoretic coating process. Acquired instantaneous impedance spectra enabled on-line insight into impedance changes upon steel substrate polarization duration, thus visualizing coating application progress. DEIS allowed estimation of the time necessary for the coating/steel substrate system to achieve a steady state after polarization switch off. The proposed approach seems to be a step towards real-time monitoring of electrophoretic coating application and offers a potential for improved process control and optimization.

Keywords: cataphoresis; cataphoretic coating; dynamic electrochemical impedance spectroscopy; polarization; electrical properties

1. Introduction

Cataphoresis is one of the most popular methods of organic coating application on metallic substrates, in particular steel, galvanized steel, aluminium and cast iron [1-3]. This approach employs the ionization of a mixture of chemical substances in an electric field. It consists in the deposition of waterborne paint on an immersed element, which is going to be protected with a coating. This element constitutes a negative electrode (cathode), which attracts positively charged paint molecules travelling along the electric field lines. Polymer resins, most frequently

*Corresponding author. Phone: +48 58 348-63-96 Fax: +48 58 347-10-92
E-mail: micszoci@pg.edu.pl

epoxy or acrylic ones, are dissolved in slightly acidic liquid phase where they form colloidal solution of microscopic durable micelles. They gain a positive charge and move towards the negatively charged object.

There are numerous advantages of cataphoretic coating application. Due to electrostatic attraction, the paint molecules are capable of uniform deposition, even on hardly-accessible, complicated surfaces. The application process is not only very efficient (paint losses are lower than 10%) and results in aesthetic films, but it is also characterized by low nuisance to the natural environment. This is because of the small amount of sewage produced as well as low emission of volatile hazardous pollutants during polymerization. Coating application via cataphoresis can be easily automated for continuous coating process, although cataphoretic coating installations are complicated and thus expensive.

Disadvantages of cataphoretic coating engulf the facts that only conductive substrates can be protected in this way and that only a single coating layer can be applied due to the blocking effect of the previously deposited film.

The final product is obtained in a three-step process: (i) substrate surface preparation, often including application of conversion coating, (ii) organic coating deposition and (iii) polymerization upon baking in the oven for a defined time depending on the type of paint.

The fields of application of cataphoretic coatings include industrial constructions and appliances, protective primers on car bodies in the automotive industry, components and casings of various machines and electronic devices, agricultural equipment, metal office furniture, garden equipment and furniture.

Cataphoretic coatings were the subject of numerous investigations, the results of which were published in the literature. Bajat et al. examined the adhesion of epoxy cataphoretic coatings on steel and steel modified with zinc alloys [4]. Water diffusion through the polymer and the ion transport along the coating-metal interface were studied on steel, hot-dip galvanised steel and AlMg(Mn) alloy with clear and pigmented cataphoretic films [5]. Much attention was paid to cataphoretic coatings on aluminium substrates. The corrosion behaviour and thermal stability of epoxy coating electrodeposited on aluminium were investigated during exposure to 3% NaCl solution by Miskovic-Stankovic and co-workers [6]. Cerium-based conversion coatings topped with cataphoretic epoxy coating were tested by Zivkovic et al. [7]. Performance of aluminium foam coated with the cataphoretic film was evaluated upon exposure in acetic acid spray chamber [8]. The dependence between the crosslinking density of epoxy cataphoretic coating

on aluminium and tendency to filiform corrosion was discussed by Romano and others [9]. Delamination and filiform corrosion of cathophoretic epoxy primer were the subjects of the paper by Olivier et al. [10]. Poulain and others employed electrochemical impedance spectroscopy and spectroscopic ellipsometry to assess filiform corrosion resistance of cathophoretic painted aluminium [11]. Investigation of the silane layer as an adhesion promotor for cathophoretic coating on galvanized steel was described by Fedel et al. [12]. Several papers were devoted to the optimization of the performance of cathophoretic primers in the automotive industry [13,14]. Almeida and co-workers published a review on electrophoretic coatings in the automotive branch [15]. Garcia and others applied the electrochemical techniques to evaluate cure temperature effects in cathophoretic automotive primers [16]. Zanella et al. deposited cathophoretic clearcoat on three metal substrates: active (bare steel), passive (nickel) and noble (gold) to verify the influence of the electrochemical behaviour of the substrates on properties of the coating [17]. The impact of ageing stress on barrier properties of cathophoretic coatings was investigated by Olivier and co-workers [18]. Some modifications, for instance, the addition of graphene oxide plates [19], were tested for improvement of cathophoretic organic coating properties.

Literature survey shows that a vast majority of the papers concern testing of durability and performance of the cathophoretic coatings in their ready-to-use state. However, there is little information about the investigation of the coating process itself – its progress, dynamics, stability, the influence of various factors during the deposition stage. The reason for that may be the fact that cathophoretic coating is a fast and complex process, which hinders its examination. Electrocoat deposition takes several seconds up to a few minutes in an industrial scale. Additionally, coating application is accompanied by a simultaneous hydrogen evolution phenomenon, which adds complexity to the task. No classic electrochemical technique allows measurement of this non-stationary process. Hence, there is a need for a dedicated tool, which makes it possible to trace the changes occurring during cathophoretic coating formation. The authors of this paper propose the application of dynamic electrochemical impedance spectroscopy (DEIS) technique, elaborated in their research group and successfully employed to the investigation of many non-stationary corrosion processes. Application potential of DEIS will be presented on selected phenomena manifested during cathophoretic coating. Our intention in this paper is not a full description of that process. It is going to be the subject of ongoing research and contributions.



2. Concept of Dynamic Electrochemical Impedance Spectroscopy technique

For decades electrochemical impedance spectroscopy (EIS) has been used for the analysis of electrochemical and coating systems. The concept of measurement consists in determination of a system's resistance using ac perturbation signal. Analysis of the results obtained for a wide range of perturbation frequencies provides information about the structure and condition of the system under investigation. Nevertheless, EIS also possesses certain limitations. They are mainly connected with nonlinearity and non-stationarity of measured objects. The first problem concerns the phenomena, which exhibit nonlinear current-voltage characteristics. In this case, mono-frequency perturbation results in a polyharmonic response. EIS is based on an analysis of the fundamental component only, so in the case of nonlinearity, the results are burdened with an error. Nonlinearity phenomenon is typical for electrochemical processes and to minimize it the perturbation signal magnitude does not usually exceed 10mV. Another reason for the small perturbation signal (around the open circuit potential) is the fact that it should not change the electrochemical processes that are being investigated. For coating systems, when only the coating condition is examined, the nonlinearity effect is marginal. Thus, much higher amplitudes of the perturbation signal are utilized. Non-stationarity appears when the system experiences some changes during impedance measurement duration. Such a situation occurs during the cathodic coating application. The changes in a coating (resistance, capacitance, thickness) take place in a shorter time than is necessary to perform classic impedance measurement with the frequency response analysis (FRA) technique. The results obtained in this way are useless as far as coating state assessment is concerned. A new method of impedance measurement – dynamic electrochemical impedance spectroscopy (DEIS) – was elaborated to perform impedance analysis of the objects characterized by high dynamics. The idea of DEIS measurement is based on a multisinusoidal perturbation instead of a sequential one as in the classic FRA method. In this case perturbation duration is not a sum of the duration of particular perturbation frequencies. It depends exclusively on the duration of the lowest frequency included in the multisinusoidal signal:

$$t = \frac{n}{f_k} \quad (1)$$

where: t - the duration necessary to obtain the impedance spectrum, f_k - the lowest frequency component, n - the number of periods of f_k . Particular frequencies are selected in a way, which prevents successive harmonic components from overlapping on the fundamental frequencies in case of system's nonlinearity. In this case, it is recommended to employ the frequencies, the values of which belong to the prime number set. Perturbation of nonlinear systems results in the response signal having the same frequency as the perturbation. However, there may be also higher harmonic components generated, the frequency of which is a multiple of the fundamental frequency. Their amplitude is relatively low and insignificant. Nevertheless, application of a multisinusoidal perturbation, like in DEIS technique, creates a possibility of overlapping of some of the higher harmonic components, their amplification and thus generation of a substantial undesired signal. The probability of such overlap is lower when prime number frequencies are employed.

Analysis process takes advantage of the Fourier transformation. In order to avoid spectrum "leakage" effect, which introduces additional error in the results, the registers containing full periods of all analysed frequencies must be subjected to the transformation. The "leakage" occurs if the register does not contain a full period of the signal and discrete Fourier transformation provides additional spectral peaks, apart from the fundamental one. In this case, the information about response signal amplitude is deformed due to the possible overlapping of the spectra lines.

Application of the multisinusoidal signal offers an additional advantage, which is the possibility of impedance changes monitoring in the function of time or other parameters. To achieve that, the perturbation signal is applied in a continuous way and the transformation into the frequency domain is executed only on localized fragments of the register (Fig. 1). Obviously, in this case, all aforementioned principles of the perturbation frequencies selection must be also obeyed.



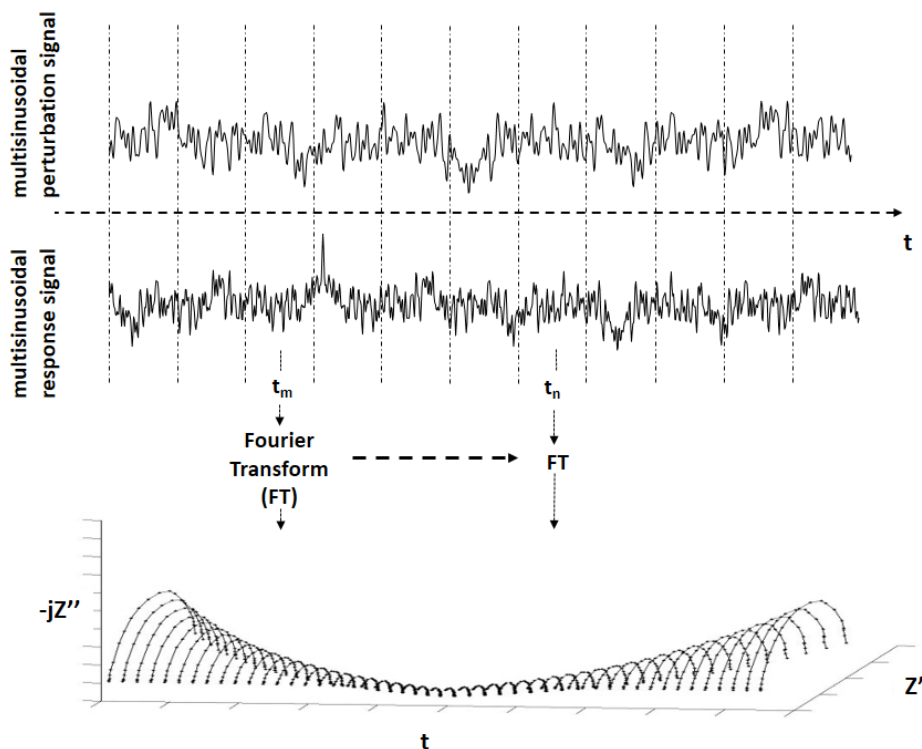

Fig. 1. Scheme presenting a determination of impedance in the function of time (t) where t_m and t_n are the exemplary time instants subjected to Fourier transformation yielding instantaneous impedance spectra shown in Nyquist format ($-jZ''$ vs. Z').

A concept of dynamic electrochemical impedance spectroscopy measurements was elaborated almost 20 years ago by Darowicki and co-workers [20,21]. Since that time the method has found wide application in the investigation of non-stationary processes under potential and current control [22-26].

3. Materials and methods

The coating under investigation was a commercially available cathodic epoxy electrocoat Powercron by PPG Co. It is a high performance, low volatile organic compounds (VOCs) and hazardous air pollutants (HAPS) free automotive primer [27]. The electrocoat was applied on a substrate made of St3S carbon steel in the form of a rod with diameter equal 0.5cm. The surface area exposed to electropaint bath was 8.0cm². The experimental cell is schematically presented



in Fig. 2. It consisted of the working electrode/cathode (steel rod), counter electrode/anode (platinised titanium mesh) and reference electrode (silver rod). The maximum dc polarization voltage applied between the cathode and anode during coating application was -5V. It was supplied by the Autolab PGSTAT302N potentiostat/galvanostat. During the investigations, the electropaint bath was subjected to continuous agitation with a magnetic stirrer set at 80rpm. Open circuit potential of the metal substrate immersed in the electropaint was ca. -0.5V versus the silver rod reference electrode. DC polarization to -5V resulted in the occurrence of two simultaneous processes – coating deposition and hydrogen evolution.

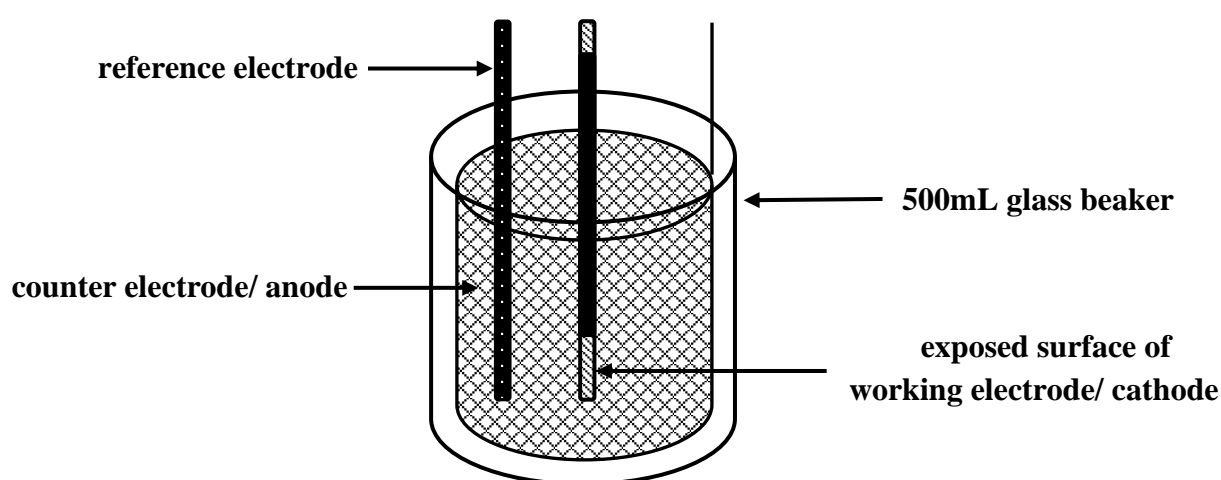

Fig. 2. Scheme of experimental cell utilized in investigations.

The ac measurements were performed with the NI-USB6356 measurement card from the National Instruments. It generated ac voltage perturbation and recorded current response signals. The ac perturbation generated by the card was supplied to the Autolab PGSTAT302N potentiostat/galvanostat via its IN input. Then the potentiostat summed the ac perturbation with the dc component and imposed them on the investigated system. Dedicated software in LabView environment was responsible for measurement control and on-line analysis of the signals registers to obtain instantaneous impedance spectra. Frequencies of the multisinusoidal perturbation signal were within the 45kHz - 3Hz range (sampling frequency $f_s=125\text{kHz}$), which allowed the acquisition of the impedance spectra averaged over the time window of 1s.

4. Results and discussion

The usefulness of the DEIS technique for on-line monitoring of cataphoretic coating application has been presented on two selected examples. The first one concerns changes in working electrode impedance during the process of electrocoat deposition.

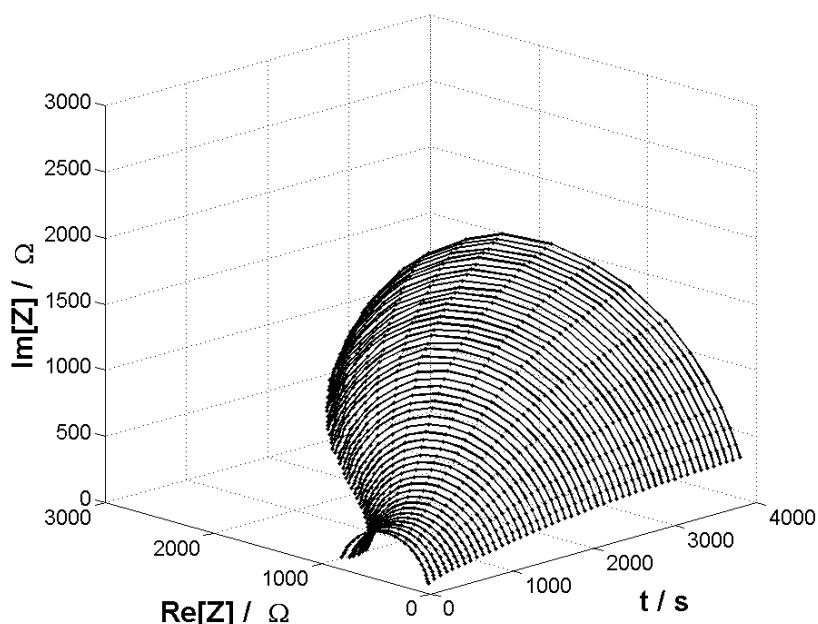

Fig. 3. Time-evolution of impedance spectra in Nyquist projection corresponding to the initial stage of cataphoretic coating for polarization maintained at -5V versus silver reference electrode. Each spectrum corresponds to the time window of 1 s.

Fig. 3 presents exemplary changes of impedance recorded during 1.1h of polarization maintained at -5V . This plot is comprised of only 50 spectra, each spectrum is averaged over the time window of 1 s. However, it should be emphasized that in the presented case the proposed method makes it possible to record single impedance spectra at the time intervals shorter than 10ms ($\Delta t=1/f_s$). Practically, it is dependent on and limited by computing power and data transfer capacity of an employed computer. It is clear that the substrate/coating system did not achieve a steady state within the presented time period. Impedance gradually increases, which is evidenced by a bigger diameter of the semicircles of the instantaneous impedance spectra. The system under investigation can be described by the electrical equivalent circuit illustrated in Fig. 4.

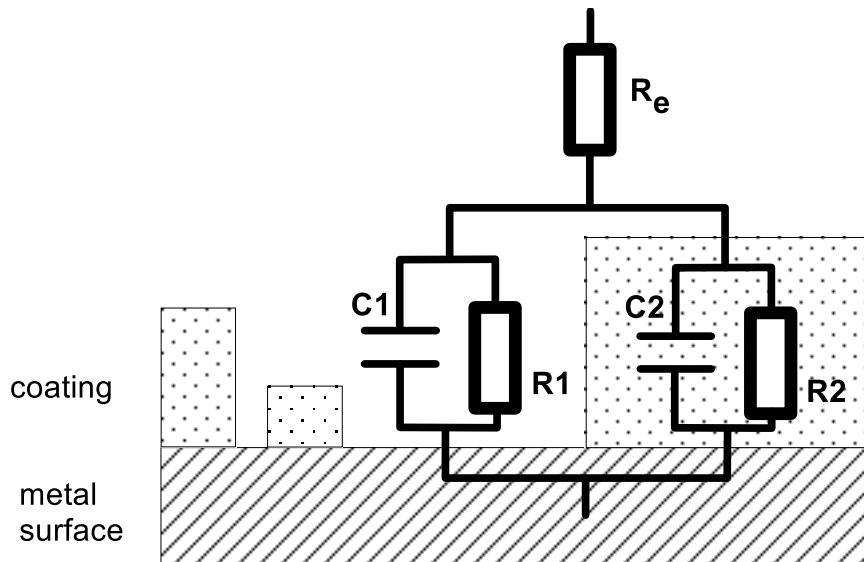

Fig. 4. Electrical equivalent circuit corresponding to investigated metal substrate/coating system: R_e – electrolyte (liquid electropaint) resistance, C_1 – double electrical layer capacitance, R_1 – charge transfer resistance of hydrogen liberation process, C_2 – coating capacitance, R_2 – coating resistance.

Apart from the electrolyte (liquid electropaint) resistance (R_e), the circuit represents two time constants connected in parallel. The first one (C_1R_1) corresponds to an uncoated, bare metal surface, on which the hydrogen evolution process occurs. C_1 describes double electrical layer capacitance and R_1 denotes charge transfer resistance. The second time constant can be attributed to the surface covered by the coating, where C_2 is coating capacitance and R_2 is coating resistance. Unfortunately, such combination does not allow determination of the values of particular electrical elements constituting the equivalent circuit. Measured capacitance (C) is a sum of the C_1 and C_2 capacitances connected in parallel. Similarly, measured resistance (R) corresponds to R_1 and R_2 resistances connected in parallel ($R_1 \cdot R_2 / (R_1 + R_2)$).

Our aim was to show that despite the constant level of polarization the substrate/coating system remained dynamic, even during a relatively long time. Hence, classic impedance measurements cannot be employed for evaluation of its state as the condition of stationarity is not fulfilled.

Fig. 5 presents time-evolution of recorded dc current (I), reciprocal of determined resistance ($1/R$) and capacitance (represented by the Q element of CPE, which was due to the fact that modelling of obtained impedance spectra provided the values of n parameter higher than 0.8)

during 1.1h of polarization at -5V. The changes in current and resistance with time seem identical. They suggest that an increasingly bigger fraction of the electrode surface is occupied and blocked by the electrocoat. Moreover, the final value of the current constitutes 24% of its initial magnitude, whereas the final value of resistance reciprocal makes 22% of its initial value. Such a situation occurs when charge transfer resistance (R_1) is much lower than coating resistance (R_2). Then measured net resistance of the investigated system is represented only by R_1 . Taking advantage of these observations, it is also possible to assess the area covered with the coating, which is close to 80% after 4000s of polarization. A different course of changes is obtained for the Q element of CPE related to capacitance. There is no initial plateau region and the most significant decrease is at the beginning of polarization period. Such behaviour is evidence for the complex character of the processes influencing on the magnitude of measured capacitance represented by the Q element of CPE, especially on double layer capacitance.

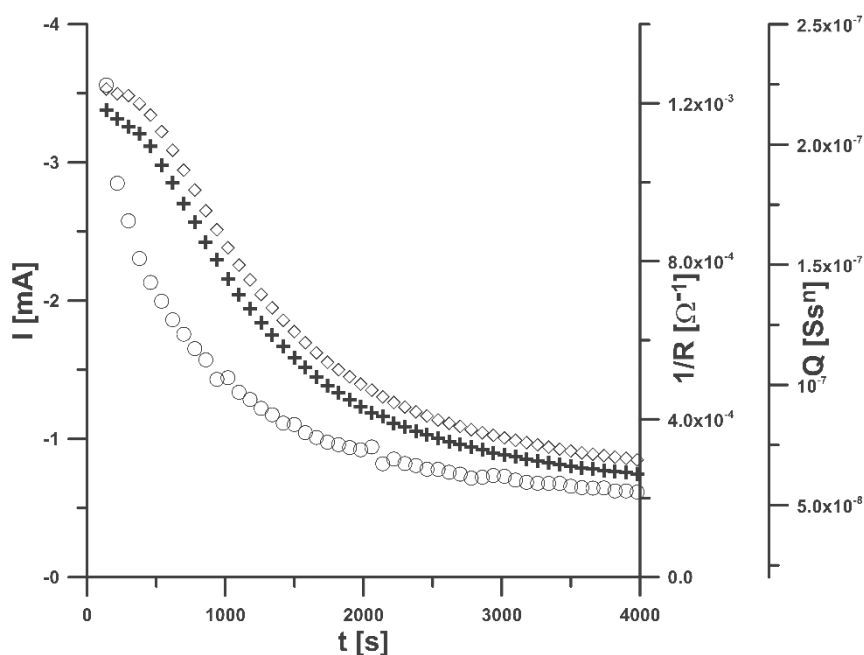

Fig. 5. Time-evolution of dc current (◇), reciprocal of determined resistance (+) and capacitance (○) (represented by the Q element of CPE) during the initial stage of the cathodic coating.

Another experiment was performed to show and prove that implementation of the dynamic electrochemical impedance spectroscopy technique can provide reliable monitoring of



cataphoretic coating application process and that in this case classic frequency by frequency impedance approach provides erroneous data resulting from high non-stationarity of the system under investigation. During cathodic polarization of the sample (-5V dc) additional, successive ac perturbation signals were applied: (A) multisinusoidal one (30 sinusoids from the 45kHz – 3Hz range), (B) sequential one (30 sinusoids from the 45kHz – 3Hz range) and (C) multisinusoidal one (the same frequency as in case of the signal A). A scheme of such perturbation is presented in Fig. 6.

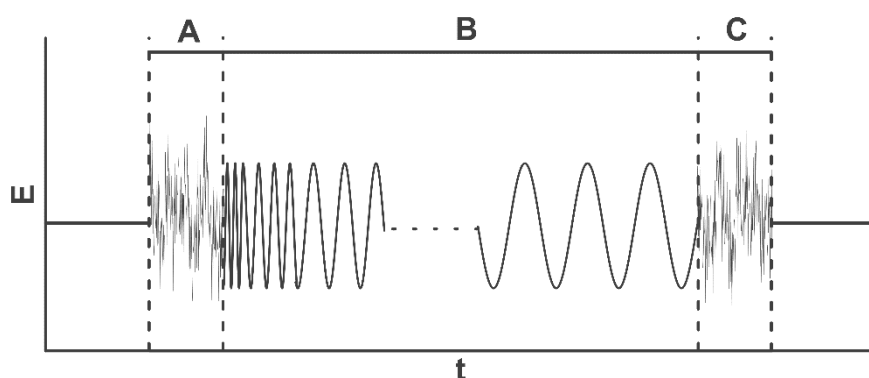

Fig. 6. Scheme of successive ac perturbation signals applied on cathodically polarized sample aimed at highlighting the advantage of DEIS approach over EIS measurement where E is the amplitude of the voltage of perturbation signal: (A) multisinusoidal signal (30 sinusoids from the 45kHz – 3Hz range), (B) sequential signal (30 sinusoids from the 45kHz – 3Hz range) and (C) multisinusoidal signal (30 sinusoids from the 45kHz – 3Hz range).

Fig. 7 illustrates a comparison of two instantaneous DEIS spectra with a frequency response analysis spectrum recorded during cataphoretic coating. The DEIS spectrum marked with diamond points was acquired after 1000s of the coating deposition process and it is averaged over the time of 1s. The spectrum having cross points is the instantaneous DEIS spectrum collected after 1500s of cataphoretic coating and it is also averaged over 1s. Circle points denote the classic FRA spectrum, which was recorded between two aforementioned DEIS spectra and its collection took 500s. The DEIS spectra take the form of regular semicircles. In their case, short perturbation time allowed the recording of the instantaneous state of the system and one can speak about the fulfilment of the condition of stationarity. The FRA spectrum representing an intermediate impedance state differs substantially from the remaining two. It is clear that the

FRA spectrum exhibits dissipation of the successive frequency points. The initial frequency points of the FRA spectrum overlap the initial frequency points of the DEIS spectrum acquired after 1000s of the coating process. On the other hand, the low-frequency points of the FRA spectrum approach the low-frequency points of the DEIS spectrum acquired after 1500s of the coating process. It is connected with non-stationarity resulting from a long time of sequential perturbation duration. In this case, 500s are too long to acquire a reliable FRA impedance spectrum, informative about the cathoretic coating deposition process. During that time window, the investigated system experiences too fast changes, so the dynamics of the discussed process can only be reflected by the instantaneous impedance spectra, like the DEIS ones presented in this paper.

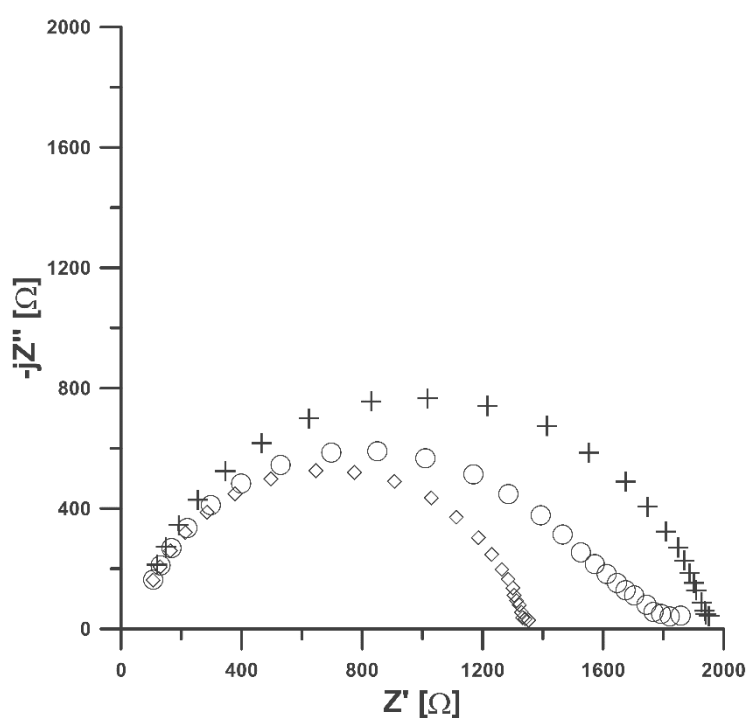

Fig. 7. Comparison of instantaneous DEIS spectra with FRA spectrum recorded during the cathoretic coating process, presented in Nyquist projection: (\diamond) DEIS spectrum acquired after 1000s of coating process (averaged over 1s), ($+$) DEIS spectrum acquired after 1500s of coating process (averaged over 1s), (\circ) FRA spectrum acquired between 1000th and 1500th second of coating process (averaged over 500s).



The second example of the benefit provided by dynamic electrochemical impedance spectroscopy regarding cathoresis on-line monitoring is the substrate/coating system behaviour after switching off the polarization (-5V) responsible for a driving force of coating deposition.

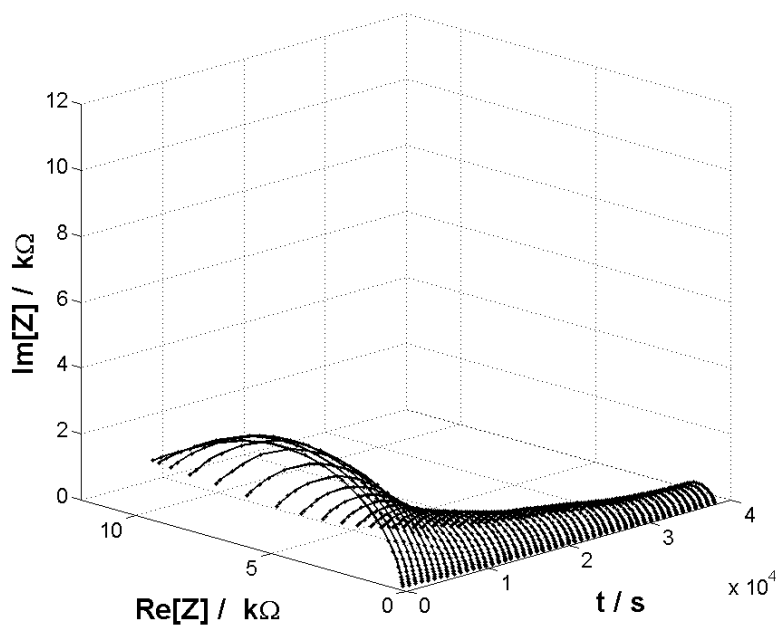

Fig. 8. Time-evolution of impedance spectra in Nyquist projection corresponding to the initial phase directly following polarization switch off, comprised of instantaneous impedance spectra collected during 40 000s after the termination of the cathoretic coating.

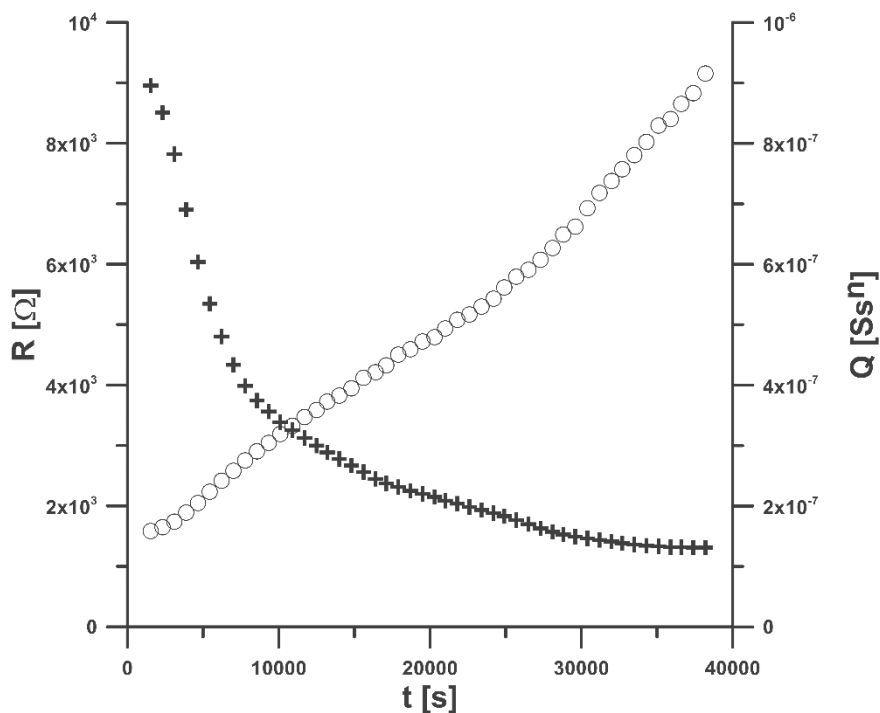

Fig. 9. Changes of resistance (+) and capacitance (O) (represented by the Q element of CPE) of the investigated sample obtained after switching the cathodic polarization off. Time period 40 000s after the termination of the cataphoretic coating.

Fig. 8 shows the changes of impedance corresponding to a 33-hour period of time following the moment when the polarization was switched off and the system drifted back to its stationary potential. Just as previously, the spectra were also modelled with the electrical equivalent circuit presented in Fig. 4. Changes of resistance (R) and capacitance represented by the Q element of CPE of the investigated sample obtained after switching the cathodic polarization off are depicted in Fig. 9. Due to lack of cathodic polarization and thus an absence of the charge transfer resistance associated with hydrogen evolution, changes of the resistance should be attributed mainly to coating resistance and to small contribution from polarization resistance connected with the substrate corrosion process. Double electrical layer capacitance is the factor influencing on the value of determined capacitance represented by the Q element of CPE. Obtained characteristics, namely a decrease in resistance and an increase in capacitance, clearly indicate that formed cataphoretic coating is unstable and undergoes electrolyte penetration.

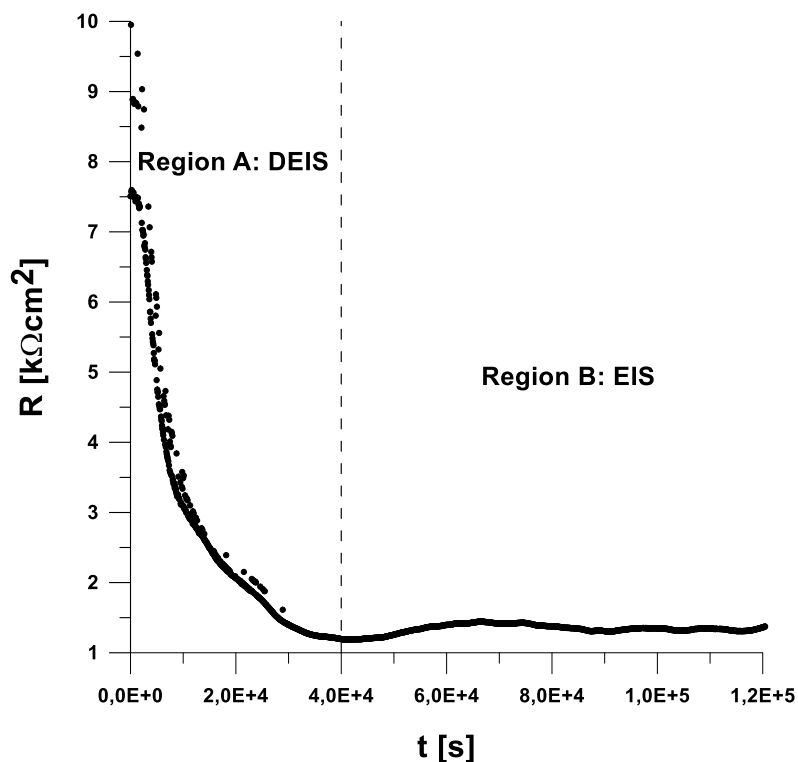

Fig. 10. Time-evolution of investigated sample resistance at open circuit potential after the termination of cathoretic coating, 33-hour time period. Two main regions can be distinguished: DEIS application range and EIS application range.

Time-evolution of the investigated sample resistance (R) during the 33-hour period following termination of the cathoretic coating process is depicted in Fig. 10. The characteristic clearly exhibits two distinct regions. The first one (Region A), directly following polarization switch off, is characterized by a rapid and gradual decrease in the system's resistance, by almost one order of magnitude. In this region, only DEIS measurements are possible as the system is not in a stationary state. The second region (Region B) starts at about 40 000s after switching the polarization off where the system arrives at a steady state – the resistance changes are relatively small. Here classical frequency by frequency impedance measurements are possible due to long-term stability of the system so the principle of stationarity is obeyed. This example reveals that after switching polarization off the substrate/coating systems requires some time to attain stabilization. DEIS allows on-line monitoring of the system condition during that unstable period and provides information on how much time is necessary to achieve a steady state. Moreover, the DEIS approach can provide real-time information when the deposited electrocoat

quality can be evaluated using classical EIS to obtain reliable results. Otherwise, if it is done too early after switching the polarization off, one will still remain in the non-stationary regime yielding misleading results.

5. Conclusions

The cataphoretic coating is a dynamic process, which calls for special monitoring techniques overcoming the problem of substrate/coating system non-stationarity during film application. The authors proposed the utilization of dynamic electrochemical impedance spectroscopy employing a continuous multisinusoidal perturbation signal, which duration depends only on the lowest frequency used. Obtained instantaneous impedance spectra allowed on-line tracing of impedance evolution upon steel substrate polarization duration, thus visualizing coating application progress. DEIS revealed that once the polarization was switched off, the system was not immediately in stationary condition and needed some time to achieve a steady state. The DEIS approach made it possible to determine this crucial time span by following instantaneous impedance changes with time. Only after that period, it is possible to evaluate obtained coating properties and performance in a reliable way with classical FRA impedance measurement. The proposed approach seems to be a step towards real-time monitoring of electrophoretic coating application, offering a potential for improved process control and optimization.

6. References

- [1] T. Brock, M. Groteklaes, P. Mischke, *European Coatings Handbook*, second ed., Vincentz Network, Hannover, 2010.
- [2] A. Goldschmidt, H. J. Streitberger, *Basics of Coating Technology*, Vincentz Network, Hannover, 2007.
- [3] H. J. Streitberger, K. F. Dossel, *Automotive Paints and Coatings*, second ed., Wiley-VCH, Weinheim, 2008.
- [4] J. B. Bajat, V. B. Miskovic–Stankovic, D. M. Drazic, Adhesion of epoxy cathaphoretic coatings on Zn alloys, *J. Serb. Chem. Soc.* 72 (12) (2007) 1383–1392.
- [5] M. Reichinger, W. Bremser, M. Dornbusch, Interface and volume transport on technical cathaphoretic painting: A comparison of steel, hot-dip galvanised steel and aluminium alloy, *Electrochim. Acta* 231 (2017) 135–152.
- [6] V.B. Miskovic-Stankovic, M.R. Stanic, D.M. Drazic, Corrosion protection of aluminium by a cathaphoretic epoxy coating, *Prog. Org. Coat.* 36 (1999) 53–63.
- [7] L. S. Zivkovic, J. B. Bajat, J. P. Popic, B. V. Jegdic, S. Stevanovic, V. B. Miskovic-Stankovic, Protective properties of cathaphoretic epoxy coating on aluminium alloy AA6060 modified with electrodeposited Ce-based coatings: Effect of post-treatment, *Prog. Org. Coat.* 79 (2015) 43–52.
- [8] S. Rossi, M. Calovi, M. Fedel, Corrosion protection of aluminium foams by cathaphoretic deposition of organic coatings, *Prog. Org. Coat.* 109 (2017) 144–151.
- [9] A. P. Romano, M. G. Olivier, A. Nazarov, D. Thierry, Influence of crosslinking density of a cathaphoretic coating on initiation and propagation of filiform corrosion of AA6016, *Prog. Org. Coat.* 66 (2009) 173–182.
- [10] M. G. Olivier, M. Poelman, M. Demuynck, J. P. Petitjean, EIS evaluation of the filiform corrosion of aluminium coated by a cathaphoretic paint, *Prog. Org. Coat.* 52 (2005) 263–270.
- [11] V. Poulain, J. P. Petitjean, E. Dumont, B. Dugnoille, Pretreatments and filiform corrosion resistance of cathaphoretic painted aluminium characterization by EIS and spectroscopic ellipsometry, *Electrochim. Acta*, 41 (1996) 1223–1231.
- [12] M. Fedel, M. E. Druart, M. Olivier, M. Poelman, F. Deflorian, S. Rossi, Compatibility between cathaphoretic electro-coating and silane surface layer for the corrosion protection of galvanized steel, *Prog. Org. Coat.* 69 (2010) 118–125.

- [13] S. J. Garcia, J. Suay, Optimization of deposition voltage of cataphoretic automotive primers assessed by EIS and AC/DC/AC, *Prog. Org. Coat.* 66 (2009) 306–313.
- [14] S. J. Garcia, J. Suay, A comparative study between the results of different electrochemical techniques (EIS and AC/DC/AC). Application to the optimisation of the cataphoretic and curing parameters of a primer for the automotive industry, *Prog. Org. Coat.* 59 (2007) 251–258.
- [15] E. Almeida, I. Alves, C. Brites, L. Fedrizzi, Cataphoretic and autophoretic automotive primers. A comparative study, *Prog. Org. Coat.* 46 (2003) 8–20.
- [16] S. J. Garcia, M. T. Rodriguez, R. Izquierdo, J. Suay, Evaluation of cure temperature effects in cataphoretic automotive primers by electrochemical techniques, *Prog. Org. Coat.* 60 (2007) 303–311.
- [17] C. Zanella, A. Pedrotti, M. Fedel, F. Deflorian, Influence of the electrochemical behaviour of metal substrates on the properties of cataphoretic clearcoat, *Prog. Org. Coat.* 77 (2014) 1987–1992.
- [18] M. G. Olivier, A. P. Romano, C. Vandermiers, X. Mathieu, M. Poelman, Influence of the stress generated during an ageing cycle on the barrier properties of cataphoretic coatings, *Prog. Org. Coat.* 63 (2008) 323–329.
- [19] S. Rossi, M. Calovi, Addition of graphene oxide plates in cataphoretic deposited organic coatings, *Prog. Org. Coat.* 125 (2018) 40–47.
- [20] K. Darowicki, Theoretical description of the measuring method of instantaneous impedance spectra, *J. Electroanal. Chem.* 486 (2000) 101–105.
- [21] K. Darowicki, J. Orlikowski, G. Lentka, Instantaneous impedance spectra of a non-stationary model electrical system, *J. Electroanal. Chem.* 486 (2000) 106–110.
- [22] A. S. Bondarenko, I. E. L. Stephens, L. Bech, I. Chorkendorff, Probing adsorption phenomena on a single crystal Pt-alloy surface under oxygen reduction reaction conditions, *Electrochim. Acta* 82 (2012) 517–523.
- [23] C. Desilets, A. Lasia, Dynamic impedance study of ethanol and acetaldehyde oxidation at platinum in acid solutions, *Electrochim. Acta* 78 (2012) 286–293.
- [24] P. Data, P. Pander, P. Zassowski, V. Mimaite, K. Karon, M. Lapkowski, J.V. Grazulevicius, P. Slepiski, K. Darowicki, Electrochemically induced synthesis of triphenylamine-based polyhydrazones, *Electrochim. Acta* 230 (2017) 10–21.
- [25] M-L Tremblay, D. Guay, A. Lasia, Dynamic impedance studies of ethanol oxidation at polycrystalline Pt, *Bulg. Chem. Commun.* 44 (4) (2012) 333–337.



- [26] M. T. Gorzkowski, A. Wesołowska, R. Jurczakowski, P. Slepski, K. Darowicki, M. Orlik, Electrochemical oscillations and bistability during anodic dissolution of vanadium electrode in acidic media—part I. Experiment, *J. Solid State Electrochem.* 15 (2011) 2311–2320.
- [27] <http://www.ppgecoat.com/Products/Cathodic-Epoxy.aspx> (accessed 18.06.2019).

Figure captions

Fig. 1. Scheme presenting a determination of impedance in the function of time (t) where t_m and t_n are the exemplary time instants subjected to Fourier transformation yielding instantaneous impedance spectra shown in Nyquist format ($-jZ''$ vs. Z').

Fig. 2. Scheme of experimental cell utilized in investigations.

Fig. 3. Time-evolution of impedance spectra in Nyquist projection corresponding to the initial stage of cathodic coating for polarization maintained at $-5V$ versus silver reference electrode. Each spectrum corresponds to the time window of 1 s.

Fig. 4. Electrical equivalent circuit corresponding to investigated metal substrate/coating system: R_e – electrolyte (liquid electropaint) resistance, C_1 – double electrical layer capacitance, R_1 – charge transfer resistance of hydrogen liberation process, C_2 – coating capacitance, R_2 – coating resistance.

Fig. 5. Time-evolution of dc current (\diamond), reciprocal of determined resistance ($+$) and capacitance (\circ) (represented by the Q element of CPE) during the initial stage of the cathodic coating.

Fig. 6. Scheme of successive ac perturbation signals applied on cathodically polarized sample aimed at highlighting the advantage of DEIS approach over EIS measurement where E is the amplitude of the voltage of perturbation signal: (A) multisinusoidal signal (30 sinusoids from the 45kHz – 3Hz range), (B) sequential signal (30 sinusoids from the 45kHz – 3Hz range) and (C) multisinusoidal signal (30 sinusoids from the 45kHz – 3Hz range).

Fig. 7. Comparison of instantaneous DEIS spectra with FRA spectrum recorded during the cathodic coating process, presented in Nyquist projection: (\diamond) DEIS spectrum acquired after 1000s of coating process (averaged over 1s), ($+$) DEIS spectrum acquired after 1500s of coating process (averaged over 1s), (\circ) FRA spectrum acquired between 1000th and 1500th second of coating process (averaged over 500s).

Fig. 8. Time-evolution of impedance spectra in Nyquist projection corresponding to the initial phase directly following polarization switch off, comprised of instantaneous impedance spectra collected during 40 000s after the termination of the cathodic coating.

Fig. 9. Changes of resistance ($+$) and capacitance (\circ) (represented by the Q element of CPE) of the investigated sample obtained after switching the cathodic polarization off. Time period 40 000s after the termination of the cathodic coating.

Fig. 10. Time-evolution of investigated sample resistance at open circuit potential after the termination of cathodic coating, 33-hour time period. Two main regions can be distinguished: DEIS application range and EIS application range.