

Article

Numbers, Please: Power- and Voltage-Related Indices in Control of a Turbine-Generator Set

Paweł Sokółski ^{1,*}, Tomasz A. Rutkowski ², Bartosz Ceran ³, Daria Złotecka ³ and Dariusz Horla ¹

¹ Faculty of Automatic Control, Robotics and Electrical Engineering, Poznań University of Technology, ul. Piotrowo 3a, 60-965 Poznań, Poland; dariusz.horla@put.poznan.pl

² Faculty of Electrical and Control Engineering, Gdańsk University of Technology, ul. Gabriela Narutowicza 11/12, 80-233 Gdańsk, Poland; tomasz.adam.rutkowski@pg.gda.pl

³ Faculty of Environmental Engineering and Energy, Poznań University of Technology, ul. Piotrowo 5, 61-138 Poznań, Poland; bartosz.ceran@put.poznan.pl (B.C.); daria.zlotecka@put.poznan.pl (D.Z.)

* Correspondence: sokolski.p@gmail.com

Abstract: This paper discusses the proper selection and interpretation of aggregated control performance indices values mirroring the quality of electrical energy generation by a turbine-generator set cooperating with a power system. Typically, a set of basic/classical and individual indices is used in energy engineering to ensure the mirroring feature and is related to voltage, frequency and active or reactive power deviations from their nominal values desired in the power system. In this paper, aggregated indices based on the sum of weighted integral indices are proposed, verified and built based on the well-known indices originating from control theory. These include an integral of the squared error (ISE) and an integral of the squared error multiplied by time (ITSE), applicable whenever an in-depth analysis and evaluation of various control strategies of the generation system is to be performed. In the reported research, the computer simulation tests verified their effectiveness in assessing the generated electricity on the example of a turbine-generator set controlled using a predictive control technology as well as applicability, proven by numerous simulation results to take various and different in nature requirements into account efficiently, in the form of a single aggregated index.

Keywords: system stabilizer; power system; model predictive control; recursive least squares; parameter estimation; synchronous generator



Citation: Sokółski, P.; Rutkowski, T.A.; Ceran, B.; Złotecka, D.; Horla, D. Numbers, Please: Power- and Voltage-Related Indices in Control of a Turbine-Generator Set. *Energies* **2022**, *15*, 2453. <https://doi.org/10.3390/en15072453>

Academic Editor: Marco Pau

Received: 22 February 2022

Accepted: 22 March 2022

Published: 27 March 2022

Publisher's Note: MDPI stays neutral with regard to jurisdictional claims in published maps and institutional affiliations.



Copyright: © 2022 by the authors. Licensee MDPI, Basel, Switzerland. This article is an open access article distributed under the terms and conditions of the Creative Commons Attribution (CC BY) license (<https://creativecommons.org/licenses/by/4.0/>).

1. Introduction

1.1. Preliminaries

The energy policy of the European Union forces progressive modernization changes in the structure of generation sources in power systems related to reducing the impact of energy on the environment, especially for technologies related to the energy combustion of fuels. The generation system in Poland is based 70% on coal-fired power plants. Due to the high emissivity of these sources and the high costs of the fluid gas treatment installation, the Polish Energy Policy by 2040 [1] aims to introduce progressive changes in the energy generation structure. According to the assumptions [1], the transformation of the generation system in Poland is to be based on the replacement of conventional power plants with renewable energy sources and nuclear energy. The first block of the nuclear power plant with a capacity of 1–1.6 GW is to be commissioned in 2033, for which the location was already selected at the end of 2021. The government company, Polish Nuclear Power Plants, selected the coastal location of Lubiawo-Kopalino in the Choczewo commune in Pomerania for the first nuclear reactor [2]. In the following years, it is planned to launch another five such units at intervals of 2–3 years. As for renewable energy sources, it is expected that by 2040 the installed capacity of renewable sources will increase almost twice, from the current 15% to 28.5% [3]. However, due to rapid climate changes, the transition

towards a non-nuclear renewable energy system remains a major political challenge, which can be made even worse by increases in energy supply chain uncertainty given rise by the shift away from fossil fuels [3]. The described development activities are aimed at replacing the shut down of conventional power plants in a way that conditions the fulfillment of the power balance in the system, as well as a significant reduction in the national emission of greenhouse gases and air pollutants. However, from the point of view of introducing a significant share of renewable sources, it is necessary to take the stochasticity of their work and significant fluctuations in generated power into account, which are associated with the need to equip classic coal or nuclear units with modern control systems capable of responding to dynamic changes in the power generated in the system power industry. Therefore, the optimization and analysis of dynamic responses of power unit control systems is a critical issue from the point of view of the planned development and upgrade in the generation structure of the Polish Power System. The latter has been carried out in the reported application by the use of integral-based performance indices.

There is a number of indices for evaluation of electrical energy quality, which differ in their nature and allow simultaneous, and yet independent from one another, evaluation of various characteristics of the electric power generation process. In the case of control system design, a single performance index is usually needed to clearly mirror the control quality. Introduction of the indices is, however, necessary both for the evaluation of the operation of control systems and the synthesis of controllers.

The aim of the research work described in this paper is to find the index which is related to a set of those used hitherto, as per relation to the same phenomena, and which is at the same time useful for implementation and analysis of control systems.

As the quality of electrical energy is a major factor when the development of modern societies is concerned, as well as there is a growing demand on the generation of electric power in accordance with the speed of economic development of societies, one can clearly identify a growing need to increase power plants' efficiency and improve electrical energy quality.

In order to develop solutions improving this quality, it is necessary to have appropriate methods for their assessment. Thanks to the suitably selected indices, it is possible to compare solutions and seek the superior one which satisfies all the requirements. Currently, various indices are used, derived from the control theory and energy engineering. To facilitate the synthesis and analysis of control systems, one aggregated index is needed. This article proposes to use the integral of the squared error (ISE) or integral of the squared error multiplied by time (ITSE) indices as candidates to mirror the quality of operation of the turbine-generator control system. Obviously, the performance of the turbine-generator control loop is a function of a suitable design and tuning of its controller.

In addition, as far specific characteristics of a turbine-generator set are concerned, using the proposed control method (by appropriate tuning of performance indices) clearly leads to improvement in the quality of energy generated by the turbine-generator set. It reduces rotor speed fluctuations in dynamic conditions for arbitrary load changes or for changes in a shaft torque, being typical cases in the system with renewable energy sources present. A proper tuning of controllers is followed by the possibility to fix the properties of transient- and steady-state performance in closed-loop systems [4]. To be able to evaluate the properties of such systems in a qualitative manner, performance measures need to be introduced first. These should be related to the desired properties of specific responses, and thus should be expressed in terms of both transient- and steady-state performance [5].

The obtained closed-loop system, after tuning, is a result of a compromise between the aforementioned factors, as usually steady-state error rejection is the adverse requirement with respect to the stability margins one, and it is impossible to meet contradictory aims simultaneously [6]. A shortlist of these might include: good regulation against disturbances, desirable response to commands, maintaining low amplitudes of critical signals, etc. To override this problem, it is advantageous to introduce integral performance indices to conveniently mirror the performance of the control system [7].



The integral indices assessing the control performance are widely used at the optimization stage in a minimization task of a selected performance-related cost function. To make the results portable across various platforms and applications, asymptotic tracking is usually evaluated for a span of different types of reference signals, such as a unit step, ramp or parabolic inputs, as a basic control task in feedback systems [8]. In such an application, the presented integral performance-related indices, using the information concerning the tracking error in the closed-loop system, are used as quantitative measures of the control quality. In this case, the attained minimum, coupled with selection of controller gains, mirrors the fact that optimal control policy is obtained [9].

Typically, quality indices found in the literature focus either on long-term quality assessment in order to analyze the network or on evaluating electric power suppliers. In [10], the indices are proposed to analyze the quality of electricity every month to give scores to different utility companies, whereas in [11], the authors analyze the situation in the Italian power system in the long term, looking into the continuity of supply and differences in quality between the north and the south of the country. In [12], the usage of wavelet packet transforms to measure non-stationary power quality disturbances, and in [13], wavelets are used to visualize time-varying power quality indices. Some authors use probabilistic methods to assess the power quality using Markov models [14] or the Monte Carlo method [15]. The authors of [16] use neural networks to classify the disturbances occurring in the system offline. Paper [17] contains an overview of commonly used voltage characteristics such as 10 min voltage and total harmonic distortion factor (THD) averages, 10 s frequency averages or 2 h long-term voltage fluctuation analysis. What is more, the authors of [18] use machine learning and artificial neural networks to analyze the power quality in a specific site using common parameters counted as 10 min averages as input. The aforementioned approaches focus on a single power quality index (e.g., total harmonic distortion). On the contrary, the global quality indices (GPQI) [19] proposed in the literature are based on 10/15 min time frames for which quality indices are calculated and then aggregated into a single index showing the global quality.

Despite a very valuable analysis of power quality indices, all of these approaches have, unfortunately, general (site assessment and company assessment) and long-term (10 min, months and years) focus and cannot be used in the case of control system analysis and synthesis where physical processes occur within milliseconds. Therefore, a new approach focused primarily on this particular issue is needed, which constitutes the motivation to undertake the proposed research project. The proposed quality index is expected to be able to properly assess power quality but at the same time must be useful for control systems analysis, synthesis and parameter tuning.

The presented literature review shows some separation of electrical engineering from control engineering. New publications in the field of control engineering analyze new approaches in isolation from the specific case of controlling the turbine-generator set of a nuclear power plant. Publications in the field of electrical engineering, in turn, focus on a detailed analysis of individual energy parameters, or on a global analysis of energy quality but over long periods of time. The presented article connects the achievements of control theory with the achievements of electrical engineering, and thus fills a certain gap between these areas. The conducted research is the starting point for further development of better control systems in the power industry.

The main novelty of the solution presented in the paper is the use of global quality indices with characteristics suitable for use in the synthesis of used control systems. The presented solution takes the analysis of critical parameters from the point of view of the control system of the turbine-generator set and analyzes the data taking very high resolution into account. This is to correctly assess the quality of the control system and to find the optimal controller parameters, which is not possible with the use of widely used individual, classic quality indices.

The main contribution of the work is the confirmation that the integral indices of electric power quality developed in this paper allow to determine the quality of the control



system with a single value capturing its viable characteristics. This type of approach significantly facilitates the analysis and synthesis of control systems. The model predictive control technique was applied to control the turbo-generator set, and its synthesis is based on the proposed indices.

The paper is structured as follows: Section 1.2 describes the electrical power quality definition used within this paper. Section 2 discusses the problem including the description of the power quality indices that can be found in the literature. Section 3 describes the turbine-generator set control problem which is the basis for further considerations, while Section 3.2 presents the proposed integral index. Simulation results of computing indices' values for several control systems with different parameters are presented in Section 4. The article ends with a conclusion resulting from the conducted research and lists the directions for further research.

1.2. Electrical Power Quality

As per the selected subject of the presented research, it is to be mentioned that the definition of energy generation quality depends on the loads considered and the way in which energy parameter deviations affect their final values. The definition is very customer-oriented, where a quality-related problem is defined as follows [20]:

Any power problem manifested in voltage, current, or frequency deviations that results in failure or misoperation of customer equipment.

A few types of such quality problems can be found in the literature, for example, see [17,21], among which one can list amplitude related, waveform disruption related, balance related and frequency related (Figure 1).

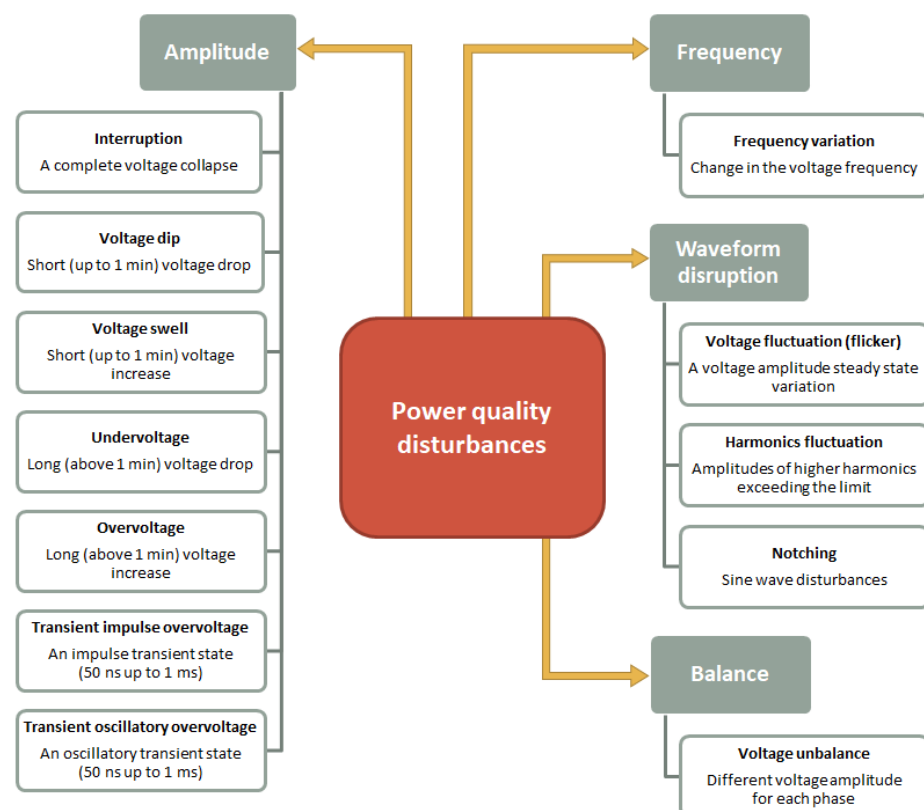

Figure 1. Different disturbance types.

As a nearly perfect sine-wave, voltage is generated by the generator [20], the current- and harmonics-related problems are omitted in this paper, since the turbo-generator set control system has no influence on these quality problems, and hence, including these

phenomena in the control-oriented indices would not result in any solution improvement. Therefore, only voltage dips, swells, undervoltage, overvoltage, voltage fluctuations and frequency variations are considered in the paper, (highlighted in bold in the previous paragraph).

The turbo-generator set control system should not introduce such problems as they can influence a large group of energy consumers [17], namely: CNC machines, adjustable speed drives, personal computers, programmable logic controllers (PLCs), relays, contactors, motor starters, fax machines, metal-halid and high pressure sodium lighting, telcom switching equipment, electronic ballast fluorescent lighting, etc.

When solving voltage and frequency stabilization control problems resulting with no disruptions in the electrical power system (EPS) given rise by the turbine-generator set, all the considerations presented above must be taken into account. To ensure high quality of stabilization, quality indices must be introduced to properly measure the results of the controller's actions, and mirror the expectations of the designer. From this viewpoint, the power quality index for control purposes is defined in the paper as:

The index that can quantify the behavior of the power system assessing the scale of power problems manifested in voltage, current, or frequency and that can be used for control system synthesis and evaluation.

The next Sections describe the details of the introduced control problem and introduce such control-oriented indices in a form of ISE/ITSE integrals.

2. Problem Description

Conditions of normal operation usually stipulate nominal values of signals from the networked system. These have also been used here to construct performance indices measuring the degree of deterioration from the expected conditions of work.

In contrast to the energy-generation perspective, the following time-related indices can be listed from a control-engineering-oriented point of view among others from this discipline:

- Overshoot—the largest, transient, deviation from the voltage set point;
- Stabilization time—the time after which the error is smaller than a certain deviation ϵ_r ;
- Rise time—the time for the controlled variable to rise from 10% to 90% of its final value or $\Delta Y/\Delta t$ rise rate.

The instruction for operation and exploitation of the transmission network [22] gives the value $t_r \leq 0.3$ s for the generator voltage controller U_g for $\epsilon_r \leq 0.5\%$ and a jump of 10% of the value and $\epsilon_p \leq 10\%$ at generator idle state and $\epsilon_p \leq 15\%$ at start-up, and the regulation speed must be greater than $1.5 U_n/s$.

In the literature [23], one can also find a presentation of the criteria for assessing the quality of regulation for electrical energy production, split into the following sub-criteria:

- Standard deviation
for which (1) is calculated for n measurements every 15 min during one month

$$\delta = \sqrt{\frac{1}{n} \sum_{i=1}^n (f_i - f_{\text{ref}})^2}; \quad (1)$$

- Amount and time of deviations greater than 50 mHz from the nominal frequency;
- Trumpet characteristics
must be met by the control system and are the requirement to contain the frequency waveform inside the trumpet characteristic after a sudden load step change. The curve is described by a pair of Equations (2) and (3),

$$H(t) = f_0 \pm Ae^{-t/T} \quad \text{for } t \leq 900 \text{ s}, \quad (2)$$

$$H(t) = \pm 20 \text{ mHz} \quad \text{for } t \geq 900 \text{ s}, \quad (3)$$

and defines an envelope-like bound on the transients where:

$t = 900$ s is a stabilization time of 15 min;
the constant A defines the trumpet characteristic width factor depending on the size of the power disturbance and the characteristics of the power system.

The Polish power system belongs to the European UCTE system, for which the above-mentioned width of the trumpet characteristic is defined as (4).

$$A = 1.2 \left(\frac{|\Delta P_0|}{\alpha K_{fMW/Hz}} + 0.030 \right) \quad (4)$$

where:

α is a share of the regulatory area in energy production,

$K_{fMW/Hz}$ denotes the power frequency equivalent defining the change in power in MW for a change in frequency by 1 Hz determined for the entire system.

On the basis of these requirements, it can be determined that with jumps of several hundred MW (e.g., failure of a generating unit) the permissible temporary frequency change is several dozen mHz, and after 15 min the deviation should be less than 20 mHz [23].

Additionally, a harmonic distortion can be evaluated by calculating the total harmonic distortion (THD) factor [17], but as mentioned, this type of disruption is analyzed for control purposes in this paper.

In the literature, the aggregated global power quality indices (GPQI) can also be found. In [19,24,25], two such indices are proposed and used in a form of:

- ADI— Aggregated Data Index;
- FDI— Flagged Data Index.

ADI is a sum of a set of quality parameters calculated in the 10-min time frames:

$$ADI = \sum_{i=1}^7 k_i W_i \quad (5)$$

where:

i is the number of the quality index;

k_i are the weights to balance all the components;

W_i are power quality parameters such as frequency change, voltage level, voltage variation, flicker severity, voltage unbalance, harmonic distortion and voltage change.

The second index, FDI, is used to aggregate all the event-related quality problems, i.e., dips, swells and interruptions. This index determines in percent how many of the 10 min periods were disrupted:

$$FDI = \frac{f}{n} \times 100\% \quad (6)$$

where:

f is the number of the 10 min period with disruptions,

n is the number of all 10 min periods.

ADI and FDI are used in [19,24,25] for the network with distributed generation analysis. The cons of this global power quality indices in this form are that they are calculated over a longer period of time using long time frames and that they also include quality parameters not essential for control purposes.

Therefore, for the control system synthesis, a more precise index is needed. The paper proposes using the integral power quality indices that operate on the shorter time frames and leverage only the control-related parameters. The integral indices assessing the control performance are widely used in the controllers' analysis and synthesis to optimize the performance of the control system and—as a result of that—the whole controlled plant. As mentioned above, optimizing the operation of nuclear power plants is an important issue due to the dynamic development of renewable energy and thus control-oriented indices

are needed to properly assess the power quality and performance of the plant. Said indices are presented in the following section.

3. Model and Methods

The classic generator regulation system consists of an excitation controller; its task is to maintain a constant value of the generator voltage and a power system stabilizer (PSS). The additional system of the system stabilizer, through the correction of the set value, minimizes the oscillations of the active power transferred to the power system caused by the operation of the excitation controller. The system stabilizer generates an additional control signal for the generator controller, which dampens potential electromechanical oscillations and improves the dynamic stability of the turbine-generator set connected to the power grid.

In most cases, linear generator controllers are used, which in majority are based on the proportional–integral control (PI) principle. These systems are additionally equipped with a number of modifications and artificial constraints as to ensure safe operation of the turbine set. In addition, these systems receive voltage and power set values from external control systems that ensure appropriate parameters throughout the whole electrical power system (EPS) and appropriate load distribution between generating units.

The steam turbine works with a synchronous generator connected to the power grid. The turbine PI controller regulates the active power of the generator by manipulating the steam flow to the turbine and consequently affecting the torque on the assembly shaft. The active power of the generator is proportional to the torque, so the supplied mechanical energy and the received electrical energy must be in balance with the accuracy of losses—mechanical, thermal and other.

On the other hand, a PI controller of a generator regulates the voltage at the generator terminals by manipulating the excitation voltage (the non-linear relationship between the controller signal and the rectifier voltage is compensated accordingly). As shown in Figure 2:

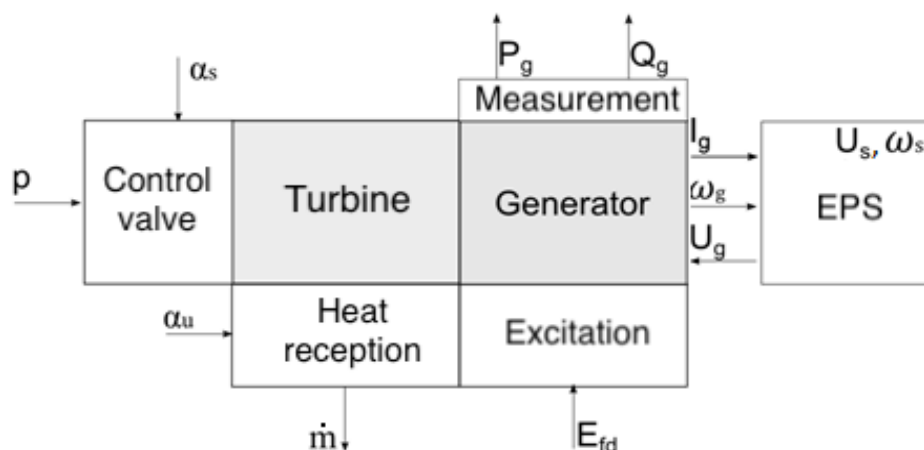

Figure 2. Turbine-generator set with a control system connected to the power system through a transformer and transmission line with heat reception.

Figure 3 presents a turbine-generator block diagram, where:

- P_g —active power;
- Q_g —reactive power;
- U_g —generator's voltage;
- I_g —generator's current;
- ω_g —generator's angular speed;
- E_{fd} —excitation voltage;
- U_s —Power system's voltage;



ω_g —Power system's voltage frequency;
 p —steam pressure;
 α_s —control valve opening;
 α_u —steam vent valve opening for the heat generation;
 \dot{m} —mass flow of the steam for heat generation;
 α_s —control valve opening.

As already mentioned in the study, appropriate models of simplified components were used for the synthesis of the turbine set control systems. The starting point for their development was the structure of the turbine set input–output model (Figure 3), which input quantities were the control valve opening degree (α) and the generator excitation voltage (E_{fd}), respectively. The outputs can be listed as the power and voltage of the generator (P_g and U_g), with the thermal load (Q) being treated as a disturbing input. Such a departure naturally leads to the internal structure of a simplified model built on the basis of four main information processing paths in the following input–output configurations: $\alpha - P_g$, $\alpha - U_g$, $E_{fd} - P_g$ and $E_{fd} - U_g$.

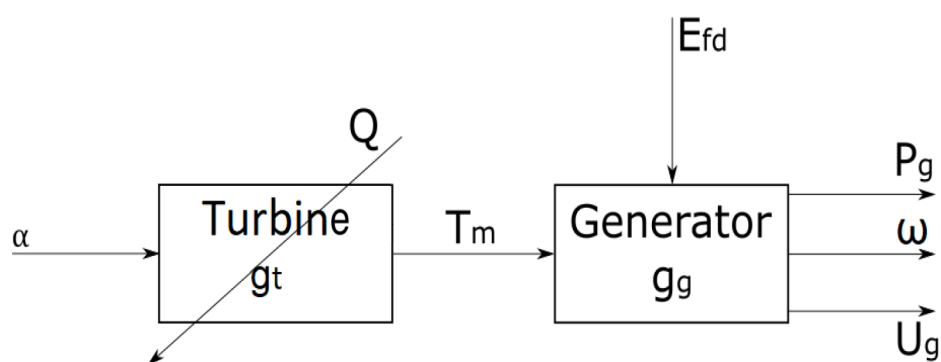

Figure 3. Inputs and outputs of the model.

3.1. Model Predictive Control

In this paper, instead of the typical integral-derivative blocks of the controller, the quadratic dynamic matrix control (QDMC) variant of an MPC controller for the purpose of control of a synchronous generator is suggested [26]. In order to obtain improved quality in the closed-loop system, i.e., the quality in a control loop taking the performance of the turbo-generator, some extent of the exchange in information between the quadratic dynamic matrix controller and the environment form is required. This is performed by introducing an additional signal between the controllers, i.e., rotational speed ω , active power P_g or the steam turbine's control valve opening degree α . In addition, in order to also take the continuously changing setpoint of the system, a recursive least-squares (RLS) algorithm is adopted here.

The proposed approach is not standard in the power generation industry or in power plant control, though it offers an easy replacement to the PID control-based algorithms [26]. As per the optimized solution of the MPC problem, not only does it take a complete set of plant-related constraints into consideration [27], but it also offers the optimal solution of the defined control problem. Since this approach can be easily reconfigured (for example by stipulating appropriate horizons of control, prediction, etc), the performance of the control law can easily mirror the expected behavior of the closed-loop system. In this paper, the parameters are adopted as to mimic the requested properties of the process.

The block diagram of the system consisting of a predictive controller (MPC) and the recursive estimation scheme (RLS) is presented in Figure 4. The solutions obtained for this considered control law, are compared among one another for various sets of configuration parameters to distinguish between those offering poor, moderate and superior performance.

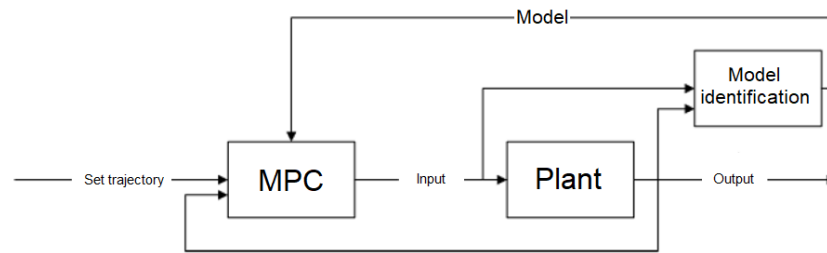

Figure 4. Structure of a QDMC controller with RLS model estimation [26].

The linear step-response model of the process is used in classical QDMC methods to estimate its future states [28,29]. Taking both free and forced response components for a multi-variable system with s inputs and r outputs, the following model is considered:

$$\underline{y}_{k+1|k} = \underline{y}_{k+1|k-1} + \mathbf{A}\Delta\underline{u}_k + \underline{y}_{k+1|k}^d \tag{7}$$

with sample number denoted as k and conditional estimate of the future sample as $\underline{y}_{k+1|k}$. The sought sequence of control signal updates calculated in m steps ahead is denoted as $\Delta\underline{u}_k$

$$\Delta\underline{u}_k = [(\Delta u_{1(k)}, \dots, \Delta u_{s(k)}), \dots, (\Delta u_{1(k+m-1)}, \dots, \Delta u_{s(k+m-1)})]^T, \tag{8}$$

comprising m values for all s inputs. For the details of the derivation of the model, and for the sake of brevity of this paper, please consult [30–33]. The optimal control update is found by solving the following problem at every sample k [28,29]

$$\begin{aligned} \min_{\Delta\underline{u}_k} J &= [\underline{y}_k^{\text{ref}} - \underline{y}_{k+1|k}]^T \mathbf{\Gamma} [\underline{y}_k^{\text{ref}} - \underline{y}_{k+1|k}] + [\Delta\underline{u}_k]^T \mathbf{\Lambda} [\Delta\underline{u}_k], \\ \text{s.t. } \underline{y}_{\min} &\leq \underline{y}_{k-1|k} \leq \underline{y}_{\max}, \\ \Delta\underline{u}_{\min} &\leq \Delta\underline{u}_k \leq \Delta\underline{u}_{\max}, \\ \underline{u}_{\min} &\leq \underline{u}_k \leq \underline{u}_{\max}, \end{aligned} \tag{9}$$

with \underline{u}_k as a vector of control signals calculated on the basis of updates, $\mathbf{\Gamma} > 0$ as a weight matrix and $\mathbf{\Lambda} \geq 0$ as control update penalty term. The notation from Table 1 is used for the described model.

Table 1. Notation used throughout the paper.

Feature	Notation/Ranges	Explanation
outputs	$\underline{y} = [P_g, U_g, \omega_g]$	power, voltage, frequency
set values	$\underline{y}^{\text{ref}} = [P_{g,\text{ref}}, U_{g,\text{ref}}, \omega_{g,\text{ref}}]$	reference power, constant set voltage and frequency values
control signals	$\underline{u} = [\alpha, E_{fd}]$	control valve opening, excitation voltage
constraints	$\alpha \in [0, 100], E_{fd} \in [-0.1, 0.1]$	minimum/maximum: valve opening (0–100%), excitation system voltage ($\pm 10\%$)

The constrained quadratic programming task in (9) is used to calculate optimal control updates, implemented to the plant on the basis of a receding horizon rule. The control updates are found with a sampling period compatible with the documentation of the GTHW-600 generator [34], of which the dominating time constant is estimated at $\hat{T} = 0.0017$ s. As per a rule of thumb, to ensure at least 10 sampling periods in a dominating time constant of a model, the sampling period of $T = 0.00001$ s was selected. In relation to this period, the

output prediction horizon should fall within $10 \div 20$ samples, or $0.0001 \div 0.0002$ s in the time domain.

The QDMC scheme can be adopted in the structure as in Figure 5. In order to obtain an optimized performance, the time-related response of the model is calculated on the basis of its identified model, following possible changes in operating points. The discussion considering a proper selection of the orders of the model of the system can be found in [30–33].

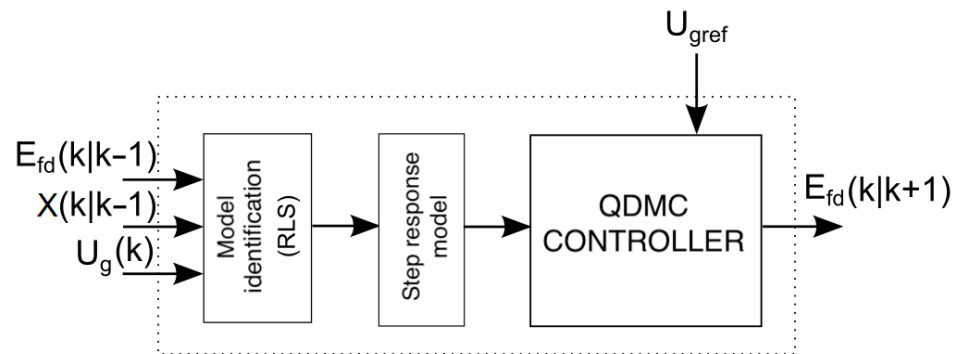

Figure 5. Model identification for the generator QDMC controller [30].

At every discrete time instant (i.e., every action taken by the QDMC controller), and for the considered structure of a discrete-time model of the plant, its parameters are estimated via RLS scheme, the step response of the multi-variable model is calculated and adopted into the MPC scheme.

It is to be mentioned here that solving an MPC problem via QDMC framework is not a bottleneck, as the solution is obtained on the basis of either efficient interior-point algorithms or on the basis of an active-set method.

At the moment, the MPC algorithms are implemented in FPGAs or efficient microcontrollers [35] and microcontrollers [36,37] to allow real-time performance, or to offer a distributed approach to MPC control of the nuclear power plant turbine set in real time.

3.2. Methodology

In order to develop an MPC controller, it is necessary to define a cost function that is used in searching for the optimal control updates which, in the context of this paper, are such that a signal for which a minimal control deviation is attained while stabilizing the voltage and angular speed of the generator while following the set active power trajectory. Each of the criteria presented in Section 2 is of a different nature and are responsible for limiting the impact of disturbances on the controlled quantities (frequency, amplitude and decay time of voltage and power and generator angular speed oscillations) or takes parameters calculated over longer periods of time into consideration. It is necessary to find the appropriate function that allows to aggregate all the requirements resulting from the operation and operating instructions. An additional component of the criterion function, which it can be extended with, are the values of control signal updates (change in the excitation voltage ΔE_{fd} and change in the opening of the control valve $\Delta \alpha$). Such an extension of the criterion allows one to determine the quality of the regulation in relation to its cost (energy expenditure on control effort).

Advanced control systems can use the model of the power plant's turbo generator set as a whole, and thus, the quality indices must take the impact on the quality of both the amplitude and the frequency of the voltage into account. Therefore, ISE- and ITSE-related indices are proposed for assessing the quality of regulation. The ISE criterion takes the following controlled quantities: voltage U_g , power P_g and frequency ω_g combined into a sum of squares-like expressions with a set of weights that determine the share of each component in the sum. Meanwhile, the ITSE index should additionally allow one to assess the accuracy of voltage amplitude and frequency stabilization (minimization of the error in normal operation) and to take the stabilization time into account by increasing the

error severity at later times (reduction in disturbances according to trumpet characteristic). Contrary to the ISE index, which is an integral of the squared error (10), it allows not only the amplitude of the disturbances to be taken into account but also the rate of their suppression, as per the weighting factor interpretation of the time product. The proposed ITSE index is used to compare the quality of various analyzed control systems. This criterion can be represented as (11). It is a starting point for further considerations regarding the selection of the best control system selected by means of—first—parameter optimization for a proposed control structure—and next—comparison of a series of different solutions (i.e., selecting the one that provides the lowest value of the index compared with the others).

Criteria (10) and (11) aggregate quality indices (1)–(4) by taking into account deviations from the set points of voltage U_g , active power P_g and frequency (ω_g). Thanks to this, all deviations and oscillation fluctuations of these quantities are taken into account. The authors have decided to use the above-listed criteria, modified with the use of a linear combination of sub-integral expressions, as per their ability to capture viable properties of the well-tuned control system in power generation tasks. Control performance in this case replaces a number of classical power generation-related criteria, with a single number capturing important characteristics.

In order to assess the deviations of various origin in a single criterion, it is necessary to assign appropriate weights. Therefore, relative values of these quantities related to their nominal values were used. Additionally, the weights (a, b, c, d, e) were used to enable the change in the influence of each component of the sum on the final value of the index in order to increase the impact of one of the component's criteria.

The article analyzes two different sets of weights to illustrate their impact on the results and usability of the proposed indices. As the base case, a set of weights equal to one was selected ($a = 1, b = 1, c = 1$). Since the sum component responsible for the active power P_g (weight a) is significantly dominant, the second case was chosen, in which a lot of emphasis is placed on changes in the ω_g speed and changes in the voltage U_g , i.e., with the weight $a = 1$, the weights $b = 1000$ and $c = 1000$ were adopted. This is to increase the sensitivity of the index to the appearance of unwanted oscillations in the system.

$$f_{\text{ISE}} = \int \left(a(U_{g,\text{ref}} - U_g)^2 + b(\omega_{g,\text{ref}} - \omega_g)^2 + c(P_{g,\text{ref}} - P_g)^2 \right) dt \quad (10)$$

where:

$P_g, P_{g,\text{ref}}$ are the active power and active power set-point;

$U_g, U_{g,\text{ref}}$ are the voltage and voltage set-point;

$\omega_g, \omega_{g,\text{ref}}$ are the angular speed and angular speed set-point;

a, b, c are the weights.

$$f_{\text{ITSE}} = \int \left(a(U_{g,\text{ref}} - U_g)^2 + b(\omega_{g,\text{ref}} - \omega_g)^2 + c(P_{g,\text{ref}} - P_g)^2 \right) t dt \quad (11)$$

The weights a, b and c were selected so that it is possible to:

- (a) Equalize the effect of factors on the overall result, as the power set point following error is of a much greater value (different order of magnitude) than the voltage amplitude and frequency fluctuations. Increasing the weights b and c allows taking the influence of these factors on the final result into account;
- (b) Distinguish between two contradictory tasks of the control system: following the active power set point and stabilizing the voltage amplitude and frequency. Due to internal interactions in the turbine-generator set, minimizing the power set point following error leads to the appearance of voltage amplitude oscillations. Therefore, further increasing b and c weights allows giving these components of the equation a dominant influence on the solution, i.e., to enhance the stabilizing effect of the system.

The next Section presents the results of simulation tests for three different sets of weights to show these three types of behavior:

- Active power following;
- Balancing the components of the equation;
- Stabilization of the amplitude and the frequency.

4. Results and Discussion

Two types of experiments were performed. The first one was to generate two dimensional surfaces of the ISE/ITSE indices' values for a control system with two parameters (turbine controller's prediction horizon p_T and generator controller's prediction horizon p_G). The latter allowed the analysis of the ISE and ITSE indices in a wide range of control cases (672 values—2 indices, 3 sets of weights and 112 different simulations). Based on these results, it is possible to select the best and worst pair of values $p_G - p_T$ for each of the cases (please refer to Table 2):

- Best/worst based on ISE for weights' set 1 ($a = 1, b = 1, c = 1$);
- Best/worst based on ITSE for weights' set 1 ($a = 1, b = 1, c = 1$);
- Best/worst based on ISE for weights' set 2 ($a = 1, b = 1000, c = 1000$);
- Best/worst based on ITSE for weights' set 2 ($a = 1, b = 1000, c = 1000$);
- Best/worst based on ISE for weights' set 3 ($a = 1, b = 100,000, c = 100,000$);
- Best/worst based on ITSE for weights' set 3 ($a = 1, b = 100,000, c = 100,000$).

The received results are shown in Tables A1–A3 (Appendix A) and in graphical form in Figures 6–8.

Table 2. Analyzed sets of parameters.

Set	a	b	c	Index	Value	Comment	p_T	p_G
A	1	1000	1000	ISE	0.004107	Best	45	22
B	1	1000	1000	ITSE	0.00106	Best	46	23
C	1	1000	1000	ISE/ITSE	0.03739/0.23799	Worst	47	10
D	1	1	1	ISE	0.00285	Best	47	23
E	1	1	1	ITSE	0.0008	Best	46	23
F	1	1	1	ISE/ITSE	0.00975/0.01061	Worst	40	10
G	1	100,000	100,000	ISE	0.0157	Best	40	17
H	1	100,000	100,000	ITSE	0.010202	Best	41	16
I	1	100,000	100,000	ISE/ITSE	3.42312/23.3972	Worst	47	10

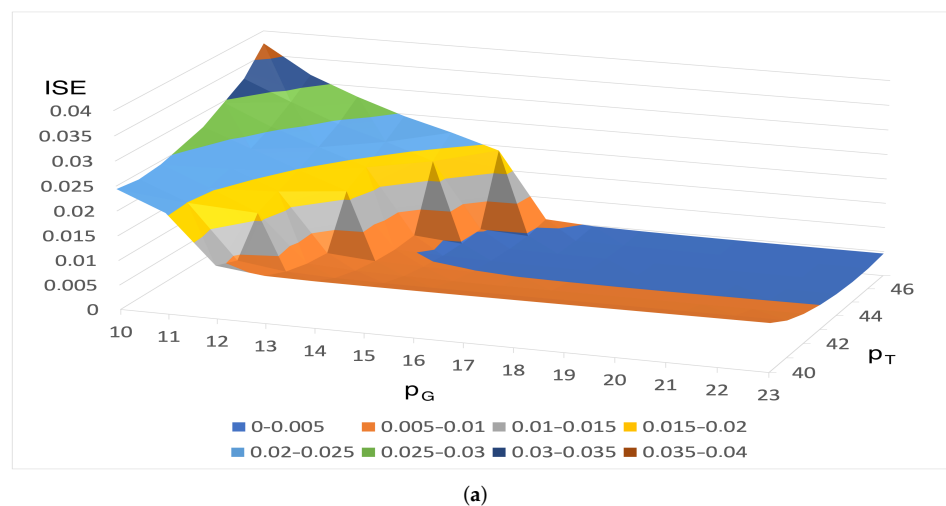

Figure 6. Cont.

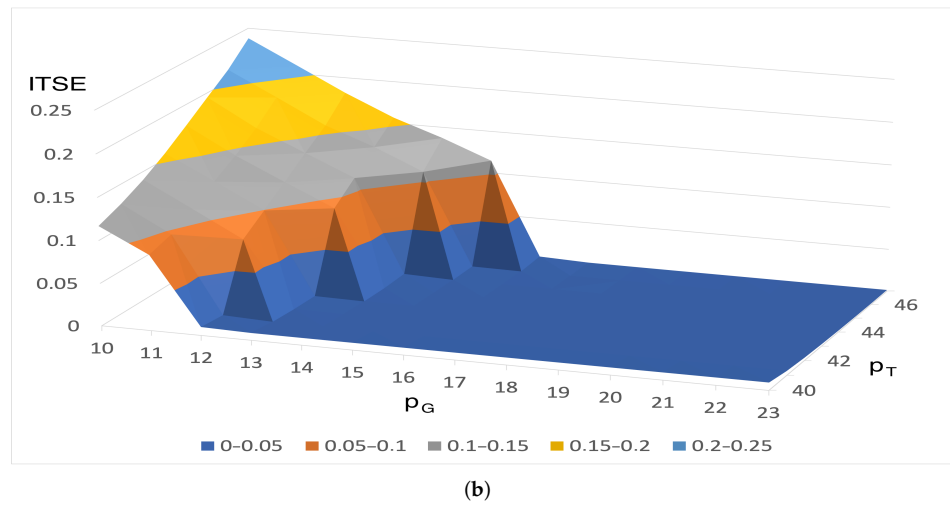

Figure 6. Indices for $a = 1, b = 1000, c = 1000 [\cdot 10^{-2}]$; (a) ISE, (b) ITSE.

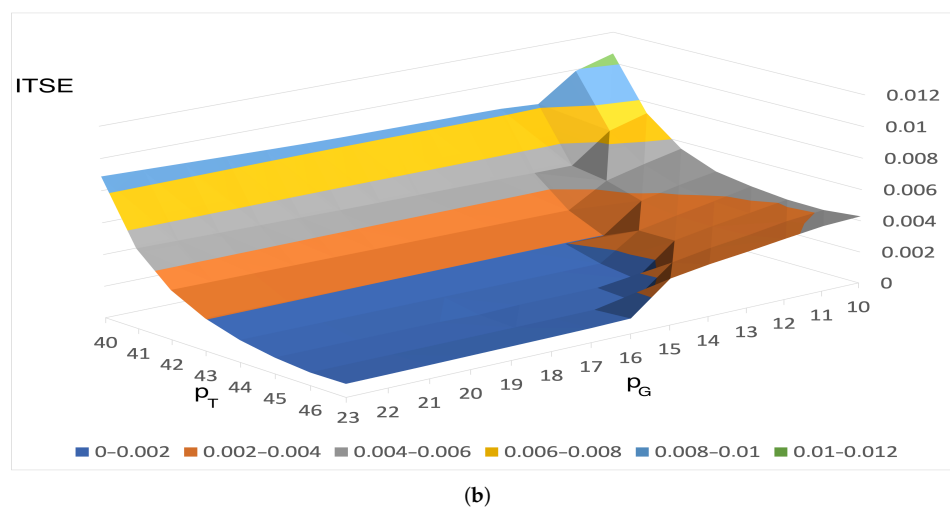
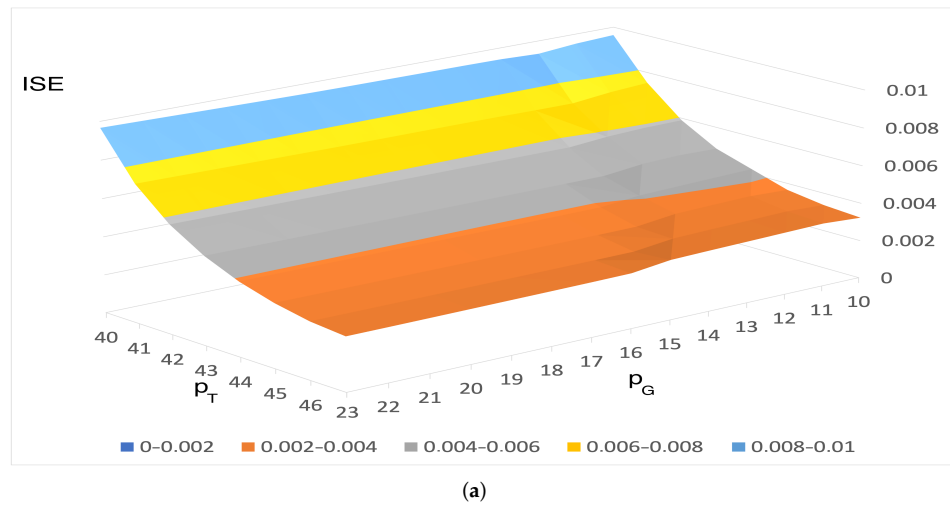

Figure 7. Indices for $a = 1, b = 1, c = 1 [\cdot 10^{-2}]$; (a) ISE, (b) ITSE.

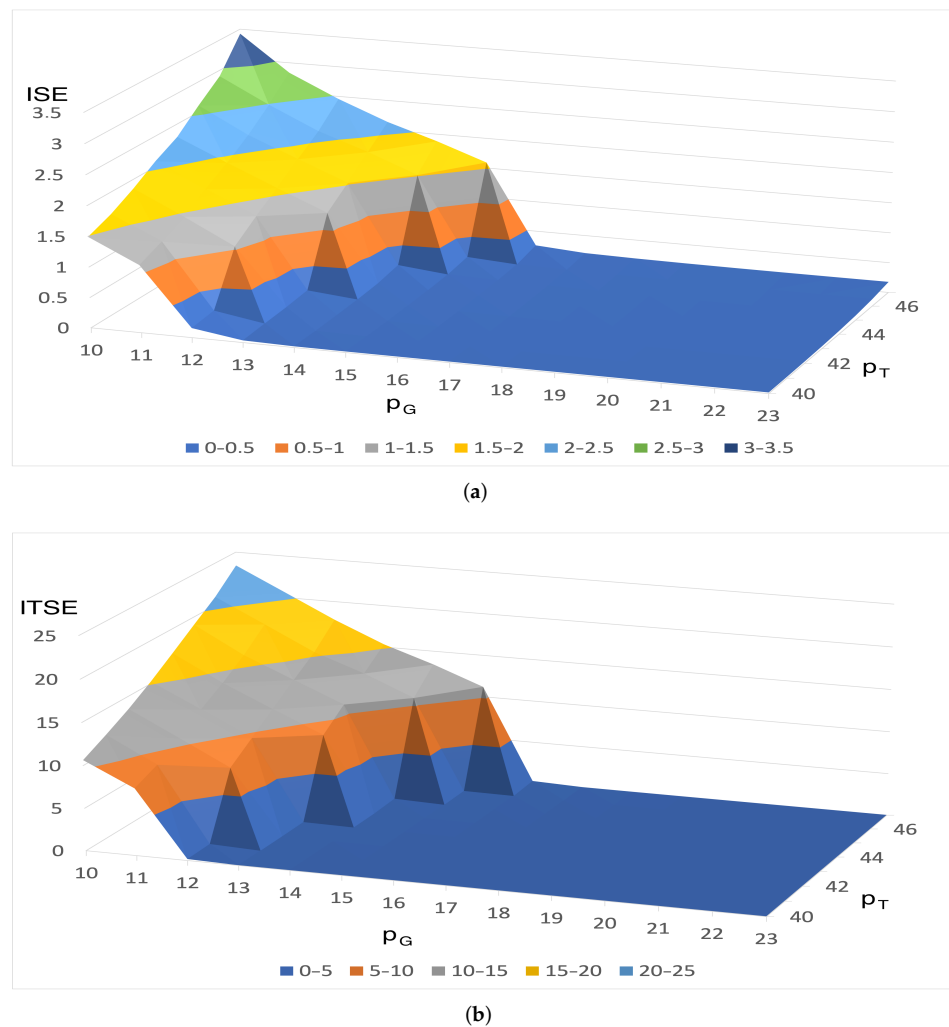

Figure 8. Indices for $a = 1$, $b = 100,000$, $c = 100,000$ [$\cdot 10^{-2}$]; (a) ISE, (b) ITSE.

In the second experiment, the simulations were performed in order to compare the process values from the turbine-generator set for those nine cases: the best and worst values of the different indices. The aim of this experiment was to find the relation between the indices and the performance of the plant (specified as the analysis of the waveforms of active power P_g , generator's voltage U_g and generator's angular speed ω_g). The results are presented in Figures 9–11.

In the first case (Figure 9), the biggest oscillations are generated by the control system C (the worst ISE/ITSE value). The system B follows the active power trajectory faster but at the cost of the higher angular speed and voltage oscillations. Similarly, in the second case (Figure 10), the system with the worst ISE/ITSE values generates the biggest oscillations. Due to internal interactions between the generator and the turbine, also in this case a slightly better active power control of the system E, worse angular power and voltage stabilization (which is nevertheless better with the system E) is caused. In this case, the differences are not as significant as in the first case. Finally, in the third case (Figure 11), system I introduces the oscillations with the biggest amplitude, while system H follows the active power trajectory best and system G introduces the oscillations with the smallest amplitude. In all the cases (Figures 9 and 10), the oscillations are reflected by the rapid changes of the control signals (control valve opening and excitation voltage), which in real-life application would damage the actuators. Therefore, the systems C, F and I can only serve as an image of the wrong selection of the controller parameters and not systems that may be used in practice. This undesired system behavior is also reflected by the values of the ISE/ITSE indices.

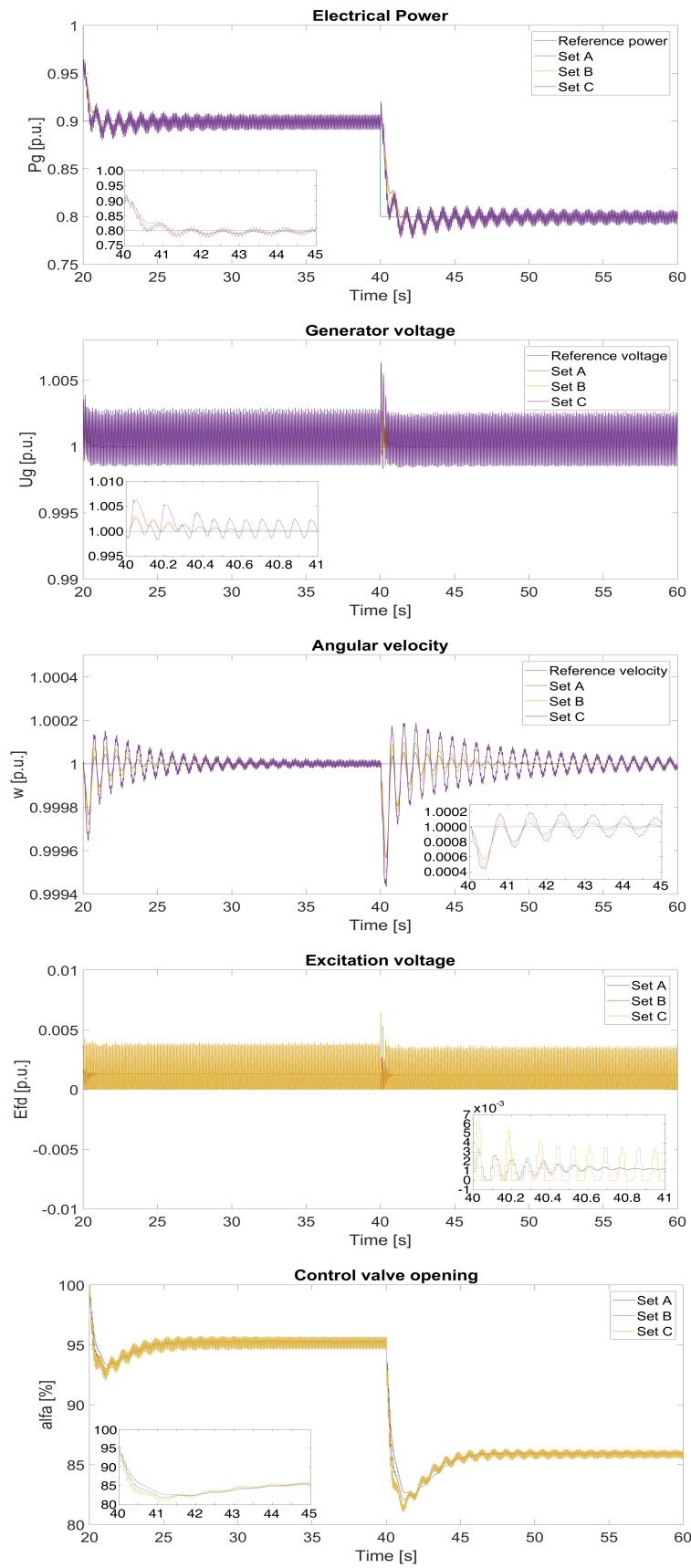

Figure 9. Results for controllers tuned using parameters: $a = 1$, $b = 1000$ and $c = 1000$.

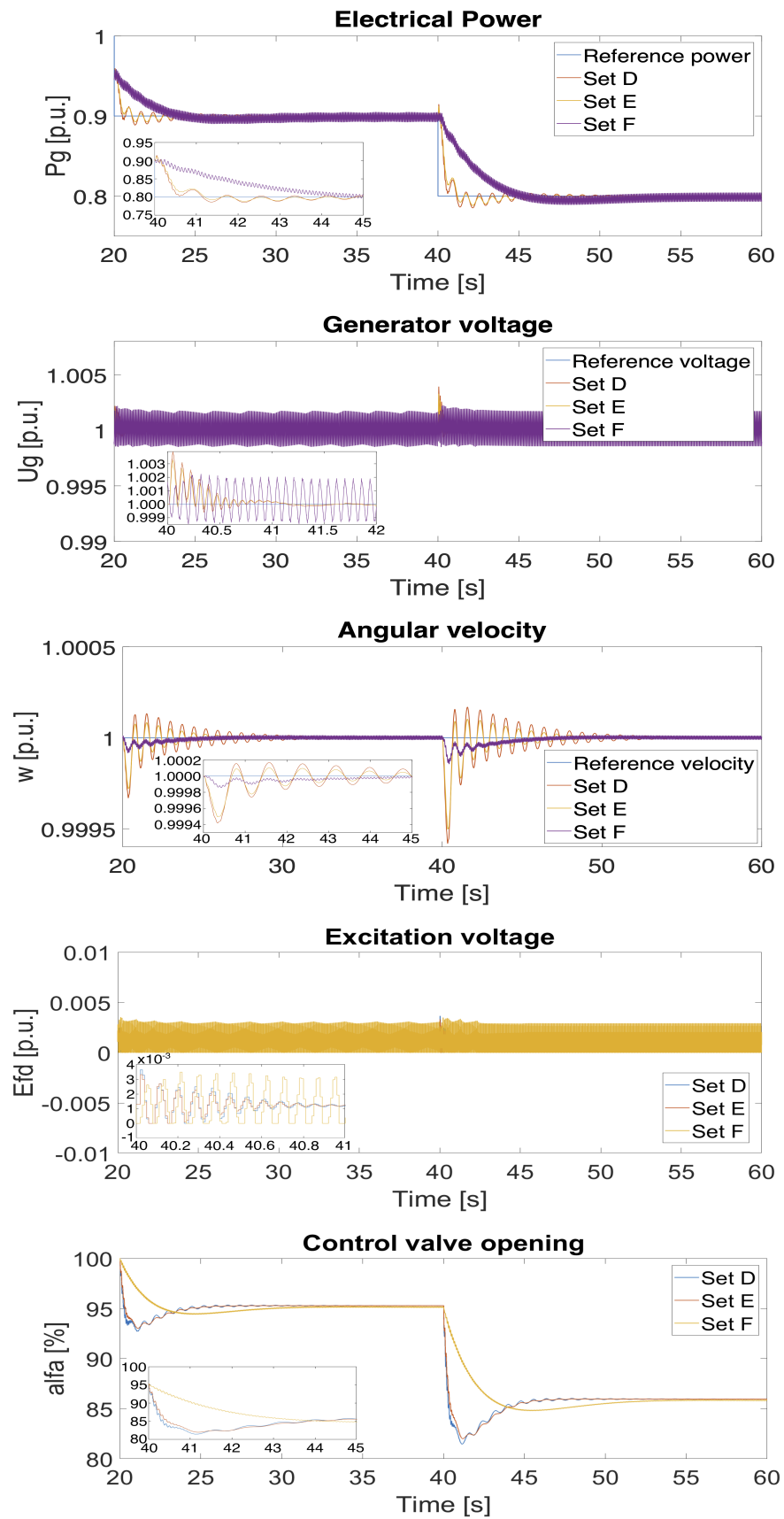

Figure 10. Results for controllers tuned using parameters: $a = 1$, $b = 1$ and $c = 1$.

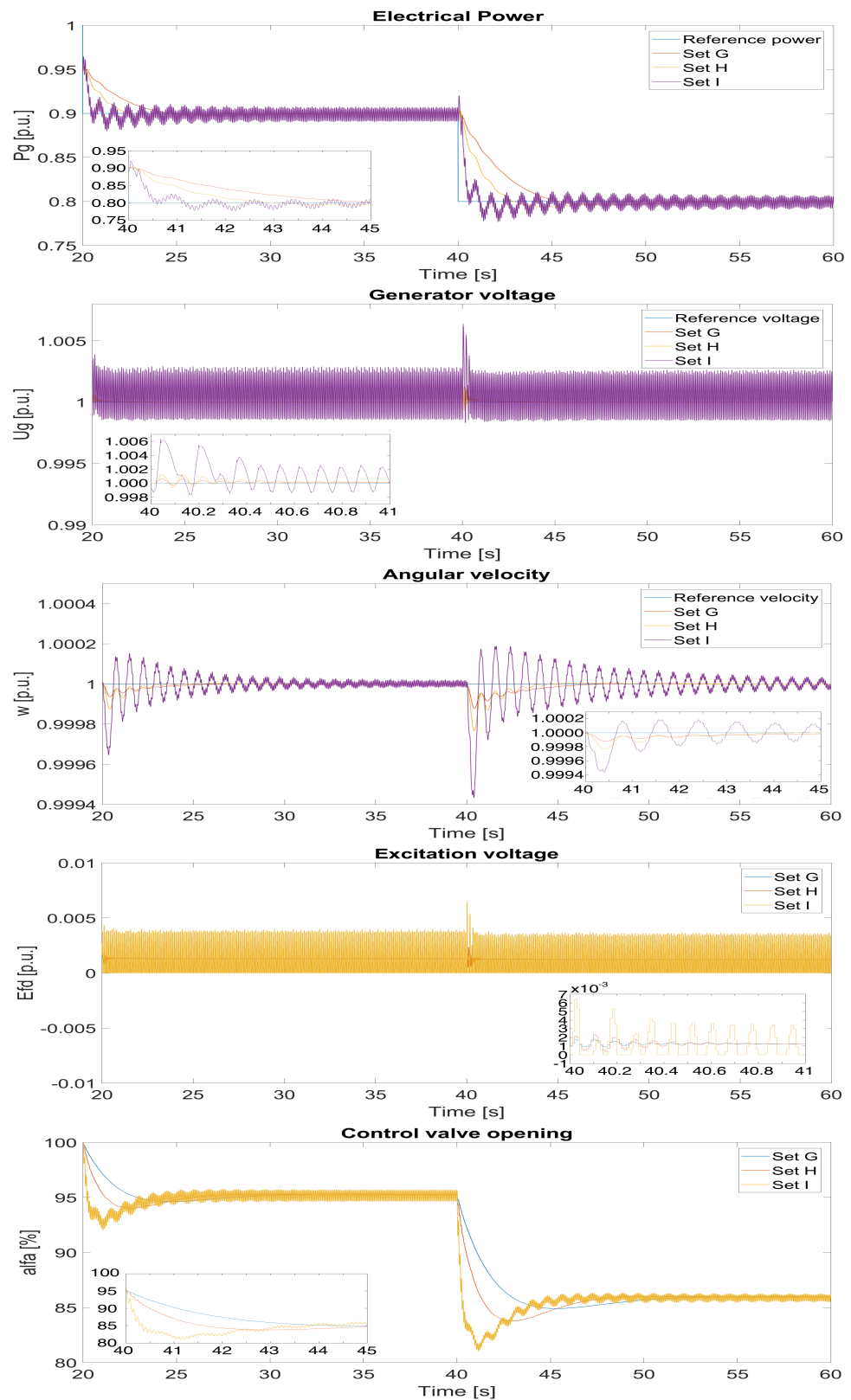

Figure 11. Results for controllers tuned using parameters: $a = 1$, $b = 100,000$ and $c = 100,000$.

The simulations performed for each group show that the behavior of the system with the worst parameters according to the ISE/ITSE criteria is, as expected, the worst (C, F, I), i.e., there are significant oscillations both in power, amplitude and voltage frequency (angular velocity). The increase in the value of integral indices is clearly reflected in the deterioration

of the course of the controlled values. The waveforms for the simulation with the use of the best parameter sets for ISE (sets A, D and G) and ITSE (sets B, E and H) are characterized by much smaller oscillations, lesser overshoot and shorter stabilization time. Improved values of ISE/ITSE indices correspond to better parameters from the point of view of control quality (i.e., classic indices of the control system quality). This also translates into the improvement in the quality of electricity by reducing the amplitude and frequency fluctuations of the voltage.

For the best pairs of ISE/ITSE results for A/B and G/H sets (reduced influence of active power P_g on indices in relation to voltage U_g and angular velocity ω_g), the power stabilization time is shorter for the best ITSE sets than for ISE sets, but at the cost of increasing oscillations in the amplitude and frequency of the voltage. For the E/F case, i.e., ISE/ITSE, the indices for all weights a , b and c are equal to 1 (equal share of components in the criterion); the waveforms for the ITSE index (set F) are characterized by both shorter regulation times and smaller oscillations of the voltage amplitude and frequency (angular velocity).

The above results are combined together to show the best ISE/ITSE cases for three different sets of weights a , b and c , i.e., comparison for ISE:

- The best ISE for weights' set A ($a = 1, b = 1000, c = 1000$);
- The best ISE for weights' set D ($a = 1, b = 1, c = 1$);
- The best ISE for weights' set G ($a = 1, b = 100,000, c = 100,000$).

Comparison for ITSE:

- The best ITSE for weights' set B ($a = 1, b = 1000, c = 1000$);
- The best ITSE for weights' set E ($a = 1, b = 1, c = 1$);
- The best ITSE for weights' set H ($a = 1, b = 100,000, c = 100,000$).

The results in this approach are presented in Figure 12.

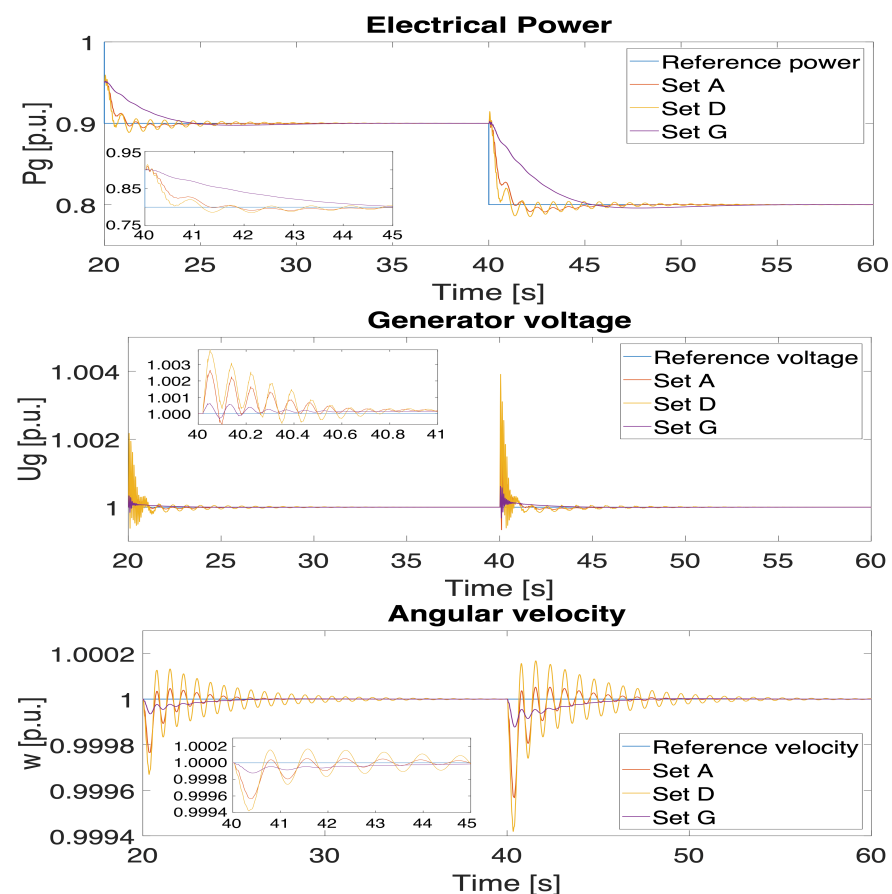

Figure 12. Electric power, generator voltage and angular speed (data set A, D, G).

Stabilization time of the active power P_g for the set D (weights $a = 1, b = 1, c = 1$) is shorter as the power takes the dominant part in the index formulation (as mentioned, the active power error has a larger order of magnitude than the other components). Increasing the weights for the generator voltage U_g and angular velocity w results in smaller oscillations but also worsens the active power stabilization time. It is caused by aforementioned interactions inside the turbine-generator set.

The ITSE index sets B and E are similar (in both cases the same set of parameters resulted in the smallest ITSE value) and, therefore, the graphs coincide (Figure 13).

As in the ISE case, higher values of the b and c weights results in smaller oscillations of the amplitude and frequency (angular velocity) of the generator's voltage (set H). For ITSE, smaller differences in weights resulted in equal parameters and outputs. Only after drastic weight changes the expected reduction in oscillations is obtained. As mentioned before, this reduction is the desired behavior of the turbine-generator set's controller and, therefore, this set of parameters results in better quality electrical energy, despite the stabilization time of the active power.

Taking all the results into account, set G mirrors the most desired control system behavior as wave-forms resulting from usage of this parameters' set are characterized by the smallest oscillations of all cases (at the expense of slower power regulation). The change in the turbine's control valve opening and the excitation voltage is also milder for this set of parameters, which has a big impact on the actuators exploitation and their up time.

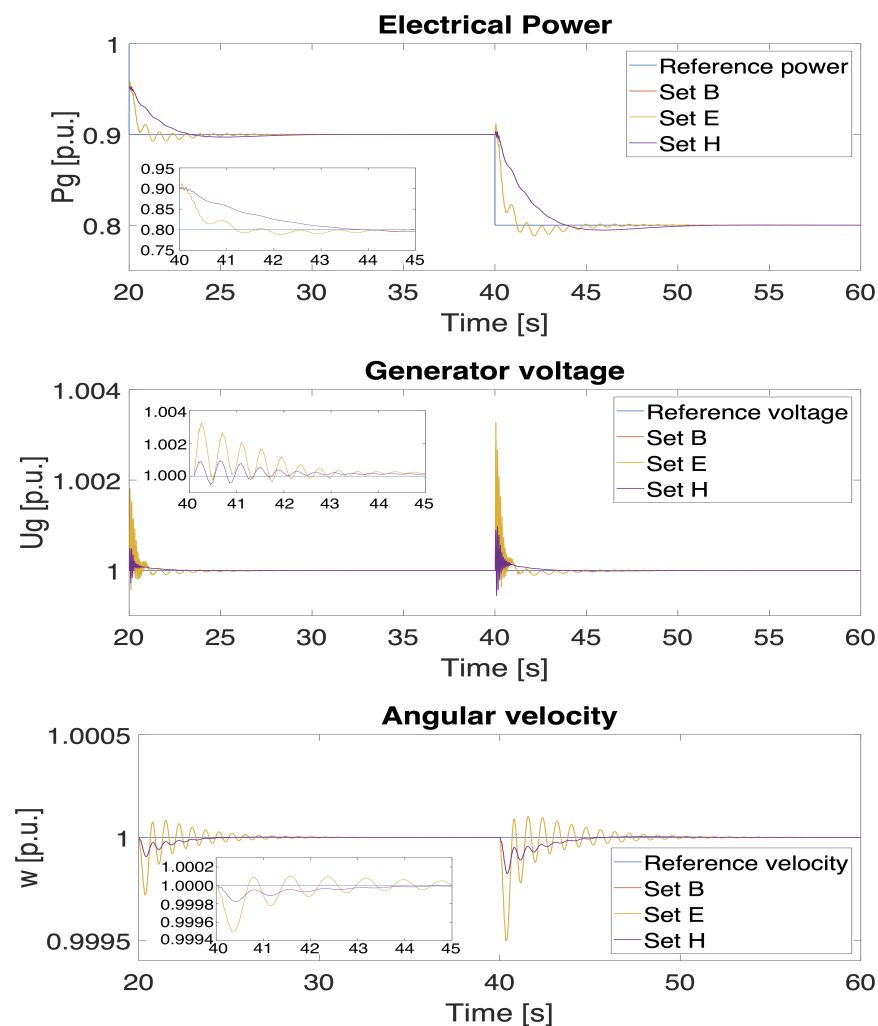

Figure 13. Electric power, generator voltage and angular speed (data set B, E, H).

5. Conclusions

The paper presents the electric energy quality indices typically used to define energy quality and proposes the use of the integral index for the synthesis of control systems. Despite the fact that multiple and various indices of the quality of electricity can be found in the literature, they still most often define quality for the purposes of long-term evaluation of energy suppliers, or in fifteen-minute terms for the purpose of checking compliance with the requirements. Both approaches are not sufficient for the synthesis of control systems.

For these purposes, a preferably single index is needed to take the transient states occurring in the system into account, i.e., changes over a period of milliseconds. This paper proposes ISE/ITSE indices in the synthesis of control systems as they are able to combine a set of different requirements in one value, also taking into consideration fast changing values. The paper consists of an in-depth analysis of the proposed indices taking a number of different approaches into consideration, such as the distinction between ISE and ITSE and three different sets of weights in each of the criteria. The presented simulation results are to illustrate how the proposed solution can be used to compare different power and voltage waveforms and what the relation between the values of the ISE/ITSE indices and the actual quality of electricity is.

The proposed solution was designed for control systems synthesis and their quality assessment and is not designed to replace existing indices used to assess compliance with the regulations. As being control oriented, these indices were used to design a set of controllers of a turbine-generator set in a nuclear power plant: a QDMC model predictive controller [38], a distributed model predictive controller [30], a fuzzy controller [39] and a controller using gain scheduling [40]. They were used to tune the control systems, i.e., to optimize the parameters of controllers, and to compare the quality of several different solutions. The results obtained during the aforementioned studies show the practical usability of the proposed indices in the control system synthesis.

The next step should be to define the range of proper, acceptable and bad values, which would enable an independent assessment of the operation of the control system. Without specific standard values for the index, they are only useful in the comparative analysis of two or more systems and cannot be used as an objective point of reference.

The novelty of the presented paper is the use of knowledge in the field of control theory in practice and the use of known ISE/ITSE indices to solve the problem of unambiguous assessment of electrical quality for the needs of the turbine set control system. Although these indices are widely used in automation, they are not used for this purpose in power engineering. This is to facilitate the synthesis of better control systems and the improvement of the quality of control in the power industry in the face of challenges related to the changing nature of the energy sector, i.e., the growth of renewable energy generation.

Author Contributions: Conceptualization, P.S., B.C. and D.H.; methodology, P.S.; software, P.S.; validation, P.S., B.C., T.A.R., D.Z. and D.H.; formal analysis, D.H., P.S.; investigation, B.C., P.S.; resources, P.S., B.C.; writing—original draft preparation, P.S., B.C., D.H.; writing—review and editing, B.C., D.H., T.A.R., D.Z.; visualization, P.S.; supervision, D.H., B.C.; funding acquisition, D.H. All authors have read and agreed to the published version of the manuscript.

Funding: This research was funded in part by the Poznan University of Technology under Grant 214/SBAD/0237.

Institutional Review Board Statement: Not applicable.

Informed Consent Statement: Not applicable.

Data Availability Statement: Not applicable.

Conflicts of Interest: The authors declare no conflict of interest.



Nomenclature

PS	Power system
PSS	Power system stabilizer
MPC	Model predictive control
DMC	Dynamic matrix control—a version of an MPC algorithm
RLS	Recursive least squares
DMPC	Distributed MPC
QDMC	Quadratic dynamic matrix control
QP	Quadratic programming
ISE	Integral of squared error
ITSE	Integral of time-weighted squared error
P_g	Active power
U_g	RMS voltage
p_G	Generator QDMC controller's prediction horizon
p_T	Turbine QDMC controller's prediction horizon
ω_g	Angular speed
THD	Total harmonic distortion

Appendix A

Table A1. Performance indices for $a = 1$, $b = 1000$, $c = 1000$.

ISE								
p_G/p_T	40	41	42	43	44	45	46	47
10	2.43873	2.37898	2.43150	2.56877	2.70616	2.96770	3.23237	3.73933
11	2.04585	1.99423	2.03829	2.18294	2.33946	2.54966	2.82709	3.15873
12	1.07685	0.91385	1.61763	1.80037	1.98392	2.21408	2.44762	2.78032
13	0.96377	0.78082	0.67022	0.62197	1.63917	1.88155	2.16327	2.45595
14	0.94998	0.74087	0.61822	0.54716	0.51792	0.55053	1.84183	2.19676
15	0.94861	0.73070	0.59927	0.52067	0.47832	0.46732	0.50724	1.90370
16	0.94945	0.72881	0.58998	0.50670	0.46186	0.44323	0.45528	0.54513
17	0.95085	0.72875	0.58674	0.49890	0.45172	0.43083	0.43831	0.48706
18	0.95338	0.72995	0.58619	0.49559	0.44458	0.42307	0.42873	0.47208
19	0.95713	0.73203	0.58700	0.49403	0.44011	0.41734	0.42262	0.46456
20	0.96138	0.73463	0.58861	0.49416	0.43798	0.41373	0.41860	0.46040
21	0.96589	0.73750	0.59048	0.49511	0.43734	0.41165	0.41623	0.45844
22	0.97046	0.74038	0.59272	0.49673	0.43766	0.41074	0.41556	0.45826
23	0.97498	0.74348	0.59505	0.49866	0.43890	0.41119	0.41593	0.45957
ITSE								
p_G/p_T	40	41	42	43	44	45	46	47
10	11.67213	12.72703	14.04284	15.67367	17.53902	19.46429	21.37105	23.79873
11	8.85470	9.68225	11.08334	12.85617	14.45448	16.28218	18.54309	21.00278
12	0.97977	0.73484	8.08074	9.95768	11.80484	13.79986	15.66905	18.17686
13	0.84906	0.51628	0.36496	0.31802	9.21858	11.33126	13.57128	15.66790
14	0.84480	0.49334	0.32117	0.23174	0.19770	0.32845	11.10305	13.71235
15	0.84617	0.49101	0.31290	0.21652	0.16481	0.14793	0.19247	11.47752
16	0.84885	0.49184	0.31092	0.21138	0.15646	0.13062	0.13313	0.36332
17	0.85180	0.49300	0.31084	0.20949	0.15272	0.12424	0.12014	0.15896
18	0.85651	0.49506	0.31177	0.20923	0.15067	0.11370	0.11424	0.14463
19	0.86347	0.49812	0.31333	0.20964	0.14991	0.11911	0.11088	0.13771
20	0.87117	0.50146	0.31513	0.21058	0.14986	0.11807	0.10848	0.13298
21	0.87921	0.50495	0.31713	0.21165	0.15023	0.11766	0.10705	0.12948
22	0.88738	0.50860	0.31911	0.21287	0.15085	0.11764	0.10635	0.12735
23	0.89559	0.51219	0.32115	0.21430	0.15172	0.11799	0.10619	0.12645

Table A2. Performance indices for $a = 1, b = 1, c = 1$.

ISE								
p_G/p_T	40	41	42	43	44	45	46	47
10	0.95698	0.74364	0.58884	0.48469	0.42488	0.36521	0.33680	0.32282
11	0.94770	0.73096	0.58715	0.48910	0.41952	0.37308	0.34469	0.33463
12	0.93025	0.70990	0.57914	0.48222	0.41367	0.36815	0.33901	0.32995
13	0.93823	0.71127	0.56211	0.46027	0.40763	0.36242	0.33453	0.32543
14	0.94051	0.71403	0.56326	0.45989	0.38713	0.33821	0.32891	0.32118
15	0.94161	0.71532	0.56434	0.46026	0.38679	0.33663	0.30440	0.31599
16	0.94311	0.71641	0.56543	0.46095	0.38688	0.33621	0.30315	0.29056
17	0.94461	0.71731	0.56612	0.46154	0.38717	0.33620	0.30244	0.28870
18	0.94701	0.71871	0.56702	0.46224	0.38766	0.33619	0.30213	0.28759
19	0.95051	0.72061	0.56822	0.46303	0.38825	0.33638	0.30192	0.28678
20	0.95441	0.72281	0.56962	0.46393	0.38885	0.33678	0.30172	0.28598
21	0.95851	0.72511	0.57092	0.46473	0.38945	0.33718	0.30182	0.28528
22	0.96261	0.72731	0.57232	0.46563	0.38995	0.33757	0.30191	0.28478
23	0.96661	0.72961	0.57362	0.46643	0.39045	0.33797	0.30211	0.28468
ITSE								
p_G/p_T	40	41	42	43	44	45	46	47
10	1.06062	0.72651	0.55370	0.46602	0.43153	0.40868	0.40519	0.42899
11	0.99157	0.65903	0.50139	0.42564	0.38488	0.37313	0.38318	0.41791
12	0.82096	0.47876	0.44205	0.37449	0.34277	0.33838	0.34654	0.38911
13	0.83651	0.47944	0.29917	0.19812	0.29713	0.29755	0.31687	0.35783
14	0.84021	0.48341	0.30072	0.19733	0.13586	0.10353	0.27644	0.33050
15	0.84210	0.48511	0.30191	0.19782	0.13543	0.09967	0.08423	0.29370
16	0.84470	0.48651	0.30311	0.19851	0.13557	0.09921	0.08237	0.09652
17	0.84740	0.48761	0.30381	0.19911	0.13592	0.09919	0.08137	0.09113
18	0.85181	0.48941	0.30481	0.19971	0.13631	0.09172	0.08096	0.08899
19	0.85841	0.49210	0.30611	0.20041	0.13681	0.09935	0.08060	0.08740
20	0.86571	0.49501	0.30751	0.20121	0.13721	0.09962	0.08020	0.08576
21	0.87331	0.49801	0.30901	0.20191	0.13761	0.09990	0.08010	0.08416
22	0.88101	0.50111	0.31041	0.20261	0.13801	0.10012	0.07995	0.08304
23	0.88871	0.50411	0.31181	0.20341	0.13841	0.10032	0.07996	0.08250

Table A3. Performance indices for $a = 1, b = 100,000$ and $c = 100,000$.

ISE								
p_G/p_T	40	41	42	43	44	45	46	47
10	1.49278	1.64440	1.85037	2.09099	2.28779	2.60873	2.90181	3.42312
11	1.10871	1.27183	1.45845	1.70042	1.92604	2.18247	2.48832	2.83025
12	0.15605	0.21124	1.04531	1.32428	1.57594	1.851440	2.11409	2.45610
13	0.03495	0.07673	0.11384	0.16647	1.23683	1.52425	1.83389	2.13588
14	0.01888	0.03401	0.06065	0.09195	0.13479	0.21591	1.51770	1.88065
15	0.01643	0.02255	0.04062	0.06507	0.09549	0.13418	0.20608	1.59244
16	0.01579	0.01957	0.03023	0.05041	0.07893	0.11049	0.15531	0.25773
17	0.01570	0.01862	0.02630	0.04202	0.06850	0.09809	0.13903	0.20145
18	0.01585	0.01844	0.02486	0.03801	0.06086	0.09033	0.12975	0.18755
19	0.01614	0.01863	0.02448	0.03566	0.05579	0.08440	0.12384	0.18083
20	0.01652	0.01906	0.02470	0.03490	0.05307	0.08040	0.12001	0.17746
21	0.01697	0.01965	0.02529	0.03506	0.05184	0.07792	0.11754	0.17619
22	0.01749	0.02035	0.02614	0.03578	0.05166	0.07662	0.11678	0.17651
23	0.01805	0.02118	0.02720	0.03692	0.05241	0.07666	0.11695	0.17792

Table A3. Cont.

ITSE								
p_G/p_T	40	41	42	43	44	45	46	47
10	10.63263	12.01967	13.50804	15.22738	17.12876	19.07859	20.99069	23.39719
11	7.88084	9.0388	10.59745	12.44710	14.08739	15.92855	18.1817	20.60945
12	0.16717	0.26113	7.65069	9.59643	11.47685	13.47821	15.34116	17.80927
13	0.02092	0.04168	0.06885	0.12200	8.93326	11.04763	13.27071	15.32883
14	0.01300	0.01478	0.02348	0.03641	0.06326	0.22619	10.84011	13.39842
15	0.01249	0.01076	0.01402	0.02070	0.03077	0.04931	0.10919	11.19785
16	0.01260	0.01020	0.01085	0.01487	0.02227	0.03243	0.05163	0.26803
17	0.01287	0.01028	0.01007	0.01238	0.01818	0.02607	0.03962	0.06881
18	0.01323	0.01055	0.01002	0.01153	0.01573	0.02292	0.03412	0.05659
19	0.01366	0.01094	0.01029	0.01124	0.01448	0.02077	0.03111	0.05123
20	0.01413	0.01141	0.01070	0.01138	0.01403	0.01946	0.02911	0.04813
21	0.01464	0.01193	0.01122	0.01176	0.01401	0.01878	0.02782	0.04621
22	0.01519	0.01251	0.01181	0.01229	0.01423	0.01854	0.02723	0.04518
23	0.01578	0.01313	0.01247	0.01294	0.01471	0.01870	0.02706	0.04482

References

- Energy Policy of Poland until 2040. Available online: <https://www.gov.pl/web/klimat/polityka-energetyczna-polski> (accessed on 4 January 2022).
- Polskie Elektrownie Jądrowe sp. z o.o. (Polish Nuclear Power Plants). Available online: <https://ppej.pl> (accessed on 9 March 2022).
- Wurster, S.; Hagemann, C. Expansion of Renewable Energy in Federal Settings: Austria, Belgium, and Germany in Comparison. *J. Environ. Dev.* **2020**, *29*, 147–168. [\[CrossRef\]](#)
- Mešanović, A.; Münz, U.; Szabo, A.; Mangold, M.; Bamberger, J.; Metzger, M.; Heyde, C.; Krebs, R.; Findeisen, R. Structured controller parameter tuning for power systems. *Control Eng. Pract.* **2020**, *101*, 104490. [\[CrossRef\]](#)
- Sobbouhi, A.; Vahedi, A. Transient stability prediction of power system; A review on methods, classification and considerations. *Electr. Power Syst. Res.* **2020**, *190*, 106853. [\[CrossRef\]](#)
- Gündeş, A.; Özbay, H. Controller redesign for delay margin improvement. *Automatica* **2020**, *113*, 108790. [\[CrossRef\]](#)
- Zhang, B.; Tan, W.; Li, J. Tuning of linear active disturbance rejection controller with robustness specification. *ISA Trans.* **2019**, *85*, 237–246. [\[CrossRef\]](#) [\[PubMed\]](#)
- Fadali, M.; Visioli, A. Chapter 3—Modeling of digital control systems. In *Digital Control Engineering*, 3rd ed.; Academic Press: Cambridge, MA, USA, 2020; pp. 60–102. [\[CrossRef\]](#)
- Dorf, R.C.; Bishop, R.H. *Modern Control Systems*, 14th ed.; Pearson: London, UK, 2022.
- Passos, A.; Souza, R.C. Defining a quality index for electric power utilities using multiple criteria decision support and time series analysis. *Gestão Produção* **2013**, *20*, 1–13. [\[CrossRef\]](#)
- Fumagalli, E.; Schiavo, L. Regulating and improving the quality of electricity supply: The case of Italy. *Eur. Rev. Energy Mark.* **2009**, *3*, 1–27.
- Morsi, W.G.; El-Hawary, M.E. Novel power quality indices based on wavelet packet transform for non-stationary sinusoidal and non-sinusoidal disturbances. *Electr. Power Syst. Res.* **2009**, *80*, 753–759. [\[CrossRef\]](#)
- Thirumala, K.; Shanatu, T.; Jain, T.; Umarikar, A.C. Visualizing time-varying power quantity indices using generalized empirical wavelet transform. *Electr. Power Syst. Res.* **2017**, *143*, 99–109. [\[CrossRef\]](#)
- Kaddah, S.S.; Abo-Al-Ez, K.M.; Megahed, T.F.; Osman, M.G. Probabilistic power quality indices for electric grids with increased penetration level of wind power generation. *Electr. Power Energy Syst.* **2016**, *77*, 50–58. [\[CrossRef\]](#)
- Rodriguez-Pajaron, P.; Bayo, A.H.; Milanovic, J.V. Probabilistic assessment of the influence of transformer rating on power quality indices in future residual networks. *Int. J. Electr. Power Energy Syst.* **2021**, *135*, 107582. [\[CrossRef\]](#)
- Zhang, Y.; Zhang, Y.; Zhou, X. Classification of power quality disturbances using visual attention mechanism and feed-forward neural network. *Measurement* **2021**, *188*, 110390. [\[CrossRef\]](#)
- Tesarova, M. *Power Quality and Quality of Supply*; University of West Bohemia: Pilsen, Czech Republic, 2011.
- Raptis, T.; Vokas, G.; Langouranis, P.; Kaminaris, S. Total Power Quality Index for Electrical Networks Using Neural Networks. *Energy Procedia* **2015**, *74*, 1499–1507. [\[CrossRef\]](#)
- Jasiński, M.; Sikorski, T.; Kostyła, P.; Borkowski, K. Global power quality indices for assessment of multipoint Power quality measurements. In Proceedings of the Conference: 2018 10th International Conference on Electronics, Computers and Artificial Intelligence (ECAI), Iasi, Romania, 28–30 June 2018. [\[CrossRef\]](#)
- Dugan, R.; McGranaghan, M.; Santoso, S. *Electrical Power Systems Quality*; McGraw Hill: New York, NY, USA, 2012.
- Watson, N.; Miller, A. Power Quality Indices Power Quality Indices: A Review. In Proceedings of the Electricity Engineers' Association Conference, Wellington, New Zealand, 24–26 June 2015.
- Instrukcja Ruchu i Eksploatacji Sieci Przesyłowej; Polskie Sieci Elektroenergetyczne: 2006. Available online: https://www.gaz-system.pl/fileadmin/pliki/iriesp/pl/IRiESP_cz1_26062006.pdf (accessed on 20 February 2022).



23. Machowski, J. *Regulacja Systemu Elektroenergetycznego*; Oficyna Wydawnicza Politechniki Warszawskiej: Warszawa, Poland, 2017.
24. Jasiński, M.; Sikorski, T.; Kaczorowska, D.N.; Rezmer, J.; Suresh, V.; Leonowicz, Z.; Kostyła, P.; Szymańda, J.; Janik, P. A case study on power quality in a virtual power plant: Long term assessment and global index application. *Energies* **2020**, *13*, 6578. [[CrossRef](#)]
25. Jasiński, M.; Sikorski, T.; Kostyła, P.; Leonowicz, Z.; Borkowski, K. Combined cluster analysis and global power quality indices for the qualitative assessment of the time-varying condition of power quality in an electrical power network with distributed generation. *Energies* **2020**, *13*, 2050. [[CrossRef](#)]
26. Sokólski, P.; Rutkowski, T.A.; Ceran, B.; Horla, D.; Złotecka, D. Power System Stabilizer as a Part of a Generator MPC Adaptive Predictive Control System. *Energies* **2020**, *14*, 6631. [[CrossRef](#)]
27. Gallieri, M.; Maciejowski, J. Model predictive control with prioritised actuators. In Proceedings of the 2015 European Control Conference (ECC), Linz, Austria, 15–17 July 2015. [[CrossRef](#)]
28. Camacho, E.; Alba, C. *Model Predictive Control*; Springer Science & Business Media: Berlin/Heidelberg, Germany, 2013.
29. Jana, A.; Samanta, A.; Ganguly, S. Globally linearized control system design of a constrained multivariable distillation column. *J. Process Control* **2005**, *15*, 169–181. [[CrossRef](#)]
30. Sokólski, P.; Rutkowski, T.; Duzinkiewicz, K. The distributed model predictive controller for the nuclear power plant turbo-generator set. In Proceedings of the 2017 22nd International Conference on Methods and Models in Automation and Robotics (MMAR), Miedzyzdroje, Poland, 28–31 August 2017.
31. Power System Dynamic Performance Committee. Dynamic Models for Turbine–Governors in Power System Studies. *IEEE Power Energy Soc.* **2013**.
32. Loo, C.; Vanfretti, L.; Liceaga-Castro, E.; Acha, E.E. Synchronous Generators Modeling and Control Using the Framework of Individual Channel Analysis and Design: Part 1. *Int. J. Emerg. Electr. Power Syst.* **2007**, *8*, 1–26. [[CrossRef](#)]
33. Sokolski, P.; Rutkowski, T.; Duzinkiewicz, K. Simplified, multiregional fuzzy model of a nuclear power plant steam turbine. In Proceedings of the 21ST International Conference on Methods and Models in Automation and Robotics (MMAR), Miedzyzdroje, Poland, 29 August–1 September 2016; pp. 379–384.
34. Imieliński, A. *Mathematical Model of Synchronous Generator for Full-Scope Simulator*; Gdańsk University of Technology, Faculty of Electrical and Control Engineering: Gdańsk, Poland, 1987, unpublished.
35. Wojtulewicz, A. Implementation of Dynamic Matrix Control Algorithm Using Field Programmable Gate Array: Preliminary Results. In *Trends in Advanced Intelligent Control, Optimization and Automation*; Springer: Cham, Switzerland, 2017.
36. Wojtulewicz, A. Implementation of DMC algorithm in embedded controller—Resources, memory and numerical modifications. In *Trends in Advanced Intelligent Control, Optimization and Automation*; Springer: Cham, Switzerland, 2017.
37. Chaber, P.; Ławryńczuk, M. Implementation of Analytical Generalized Predictive Controller for Very Fast Applications Using Microcontrollers: Preliminary Results. In *Trends in Advanced Intelligent Control, Optimization and Automation*; Springer: Cham, Switzerland, 2017.
38. Sokólski, P.; Rutkowski, T.A.; Duzinkiewicz, K. The QDMC Model Predictive Controller for the Nuclear Power Plant Steam Turbine Control. In *Advances in Intelligent Systems and Computing*; Springer: Cham, Switzerland, 2017.
39. Sokólski, P.; Kobylarz, A.; Kulkowski, K.; Duzinkiewicz, K.; Rutkowski, T.; Grochowski, M. Advanced control structures of turbo generator system of nuclear power plant. *Acta Energetica* **2015**, *3*, 83–96. [[CrossRef](#)]
40. Sokolski, P.; Rutkowski, T.; Duzinkiewicz, K. The excitation controller with gain scheduling mechanism for synchronous generator control. In Proceedings of the 2015 20th International Conference on Methods and Models in Automation and Robotics (MMAR), Miedzyzdroje, Poland, 24–27 August 2015; pp. 23–28.