

Postprint of: Dąbrowski A., Pelzner K., Krawczuk Sz., Goczkowski J., Elwertowska A., Preliminary results from HEDGEHOG REXUS project – A sounding rocket experiment on accelerations, vibrations and heat flow, Acta Astronautica, Vol. 177 (2020), pp. 80-85, DOI: [10.1016/j.actaastro.2020.07.016](https://doi.org/10.1016/j.actaastro.2020.07.016)
©2020. This manuscript version is made available under the CC-BY-NC-ND 4.0 license <http://creativecommons.org/licenses/by-nc-nd/4.0/>

Preliminary results from HEDGEHOG REXUS Project – A sounding rocket experiment on accelerations, vibrations and heat flow

Adam Dąbrowski ^{a*}, Karol Pelzner ^b, Szymon Krawczuk ^c, Jacek Goczkowski ^d, Agnieszka Elwertowska ^e

^a*Department of Mechanics and Mechatronics, Faculty of Mechanical Engineering, Gdańsk University of Technology, Narutowicza 11/12, 80-233 Gdańsk, adadabro@pg.edu.pl*

^b*Gdańsk University of Technology, karol.pelzner@gmail.com*

^c*Gdańsk University of Technology, szymon.r.krawczuk@gmail.com*

^d*Gdańsk University of Technology, jacgocz@gmail.com*

^e*Gdańsk University of Technology, agnelwer@gmail.com*

* Corresponding Author

Abstract

During flight, a sounding rocket is subject to a unique environment - severe vibrations and substantial heat flux. In order to design payloads, precise measurement of these conditions is required. This paper presents preliminary results from HEDGEHOG REXUS Project, whose scientific goal was to characterise the thermal and dynamic environment of REXUS sounding rockets. For this purpose, two new sensors have been designed - mechanical acceleration amplifier/filter and heat flux measuring device. Both provided interesting data - vibration and heat flux profiles allowed identification of key flight phases and quantitative description of certain phenomena during flight was performed. The experiment validated the sensors and provided heating and vibration profiles. Applicability of results and conclusions for future REXUS launches is discussed in the following paper.

Keywords: sounding rocket, heat transfer, vibrations, education

Acronyms/Abbreviations

BEXUS - Balloon-borne Experiments for University Students ,

DLR - German Aerospace Center,

HEDGEHOG - High-quality Experiment Dedicated to microGravity Exploration, Heat flow and Oscillation measurement from Gdansk,

MEMS - MicroElectroMechanical System,

MORABA - Mobile Rocket Base,

REXUS- Rocket EXperiments for University Students,

RTD - Resistance temperature detector,

SMARD - Shape Memory Alloy Reusable Deployment Mechanism,

SNSA - Swedish National Space Agency,

SSC - Swedish Space Corporation,

ZARM - The Center of Applied Space Technology and Microgravity.

1. Introduction

As access to space conditions is becoming ever wider, both technically and economically, scientists' interest in launching finer and more sophisticated experiments is growing. This applies now more than ever to fragile by nature biological and chemical experiments. In order to be qualified for launch such experiments need to be carefully tested prior to the event. These tests should represent the actual launch conditions as closely and in as much detail as possible. For this reason, comprehensive measurements of launch conditions are required. The most important tests for an experiment module to be accepted are vibration and thermal tests. Thus, a study was prepared - with its focus on measuring acceleration and vibration conditions (especially eigenfrequencies) as well as heat transfer inside a REXUS sounding rocket - as a reference for future ground acceptance tests.

The REXUS/BEXUS programme is realised under a bilateral Agency Agreement between the DLR and the SNSA. The Swedish share of payload is available to students from other European countries by means of collaboration with the ESA. EuroLaunch, a cooperation between the Esrange Space Center of SSC and the MORABA of DLR, is responsible for managing the campaign and operations of the launch vehicles. Experts from DLR, SSC, ZARM and ESA provide technical support to the student teams throughout the project. REXUS and BEXUS are launched from SSC, Esrange Space Center in northern Sweden [1]. REXUS experiments prior to that described herein, included various spaceborne technology demonstrators [2-4].

A REXUS vehicle consists of a one-stage spin-stabilized rocket, an Improved Orion motor [5], and payload. The rocket has a liftoff thrust of 7 kN, a core diameter of 0.35 m, and a total length of around 6 meters. It provides approximately three minutes of spaceflight with a payload mass of up to ~95kg, including the service and recovery systems. The acceleration profile is presented in Fig. 1. Altitude and air pressure profiles are presented in Fig. 2.

HEDGEHOG REXUS Project aimed to investigate deeper into the dynamic and thermal environment of payload during a sounding rocket flight. The experiment was divided into two functional parts: vibrational and thermal. The



goal of the former was to measure, with high frequency and precision, the accelerations at any moment of the flight, and to possibly associate it with such significant flight events as: liftoff, motor burnout, etc. (see Table 1). The aim of the latter was to obtain a temporal profile of heat flux on rocket skin during the flight, and correlate it with the above mentioned flight events.

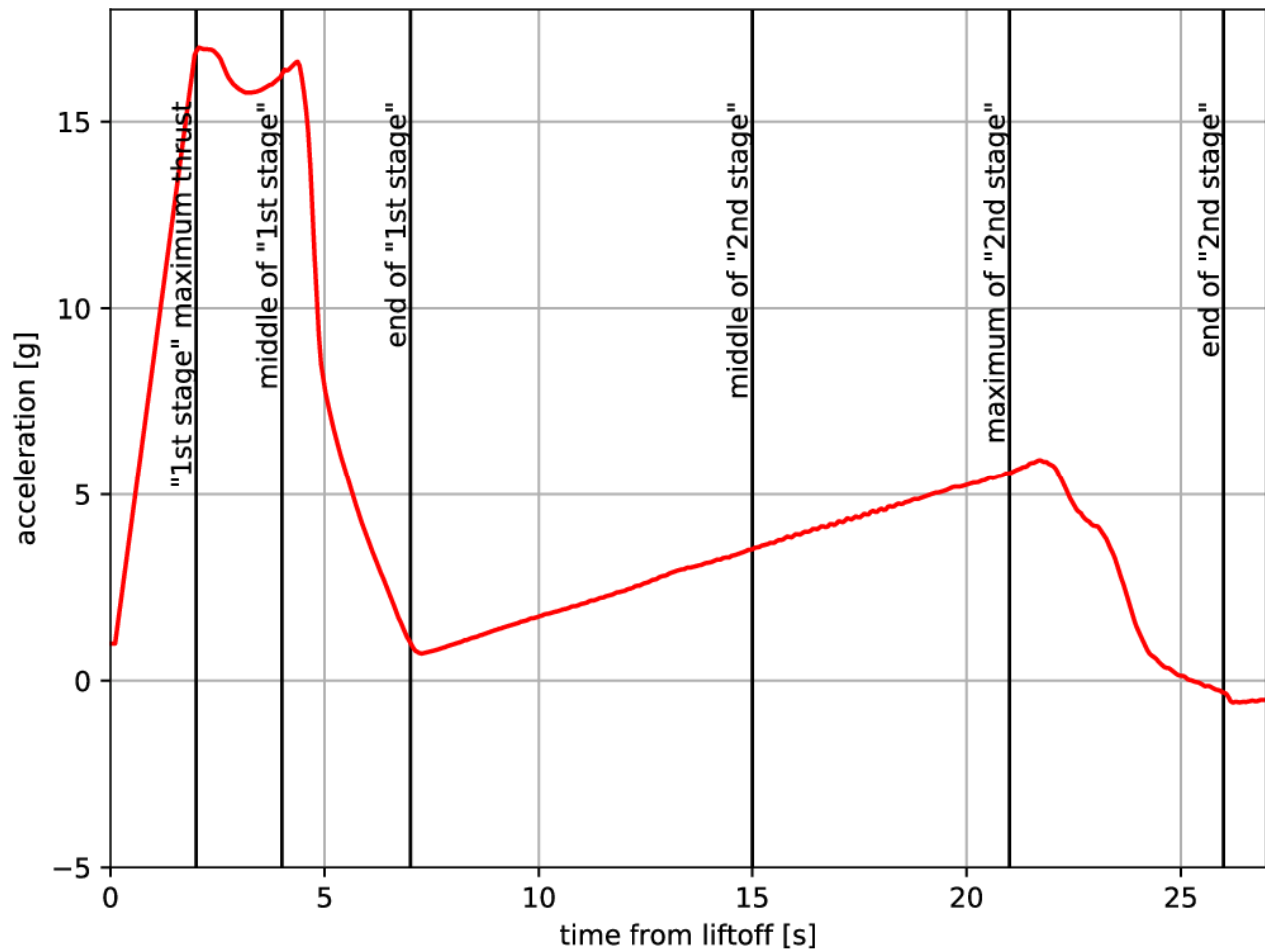

Fig. 1. Acceleration graph of the REXUS-18 vehicle with marked flight events [6].

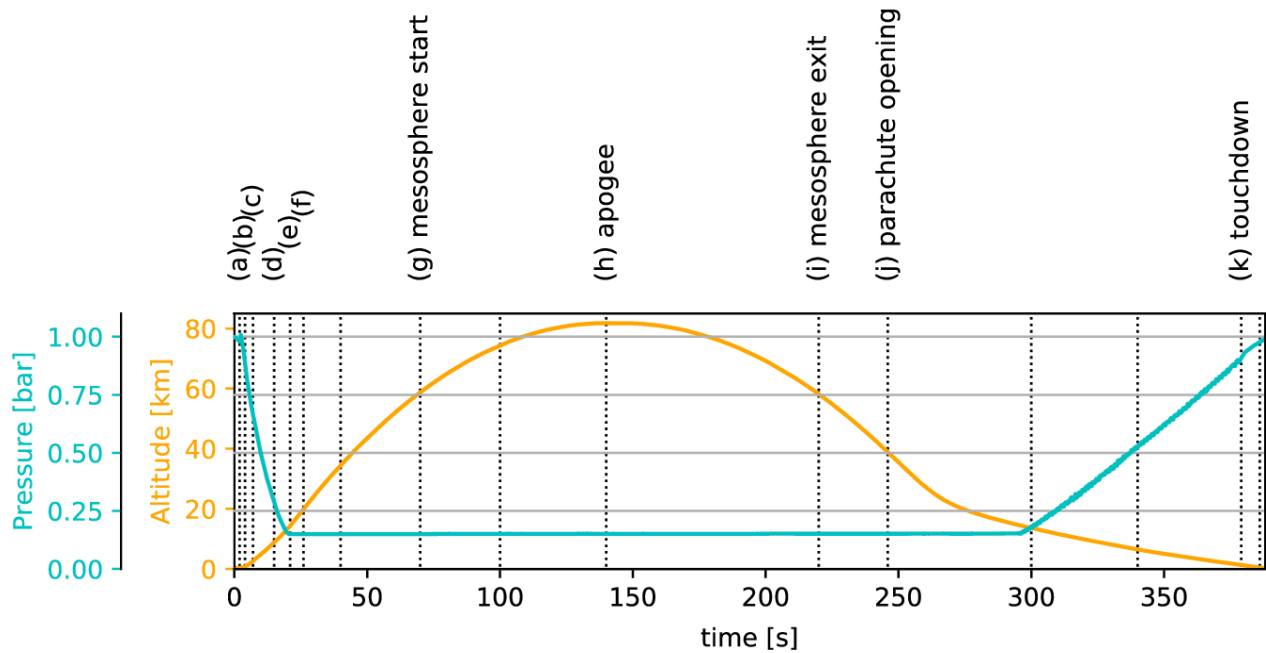

Fig. 2. Pressure and altitude graph of the REXUS-18 vehicle with marked flight events [6].

Table. 1. Characteristic phases of the REXUS vehicle flight.

time	phase
0 s	liftoff
2 s	(a) maximum thrust of "1st stage"
4 s	(b) middle of "1st stage" burn
7 s	(c) start of "2nd stage" burn
15 s	(d) middle of "2nd stage" burn
21 s	(e) maximum thrust of "2nd stage"
26 s	(f) burnout of motor
70 s	(g) entrance into mesosphere
140 s	(h) apogee
220 s	(i) egress from mesosphere
250 s – 350 s	(j) parachute deployment
830 s	touchdown

The scientific challenge of HEDGEHOG REXUS Project was to obtain precise information on the acceleration and vibration environment that the payload is subject to during the whole course of the sounding rocket flight. An envelope of environmental conditions, including spectral data, is known and publicly available [7]. However, their application is usually limited to serving as general guidelines, due to their lack of details. In case of vibrations this is usually a low frequency range of measurements, since high frequency vibrations tend to be less important in the case of robust REXUS experiments. Deep understanding of the rocket's dynamic environment is critical while designing and utilising the payload incorporating fluids [8, 9]. The second scientific objective is to measure temperature in various locations of the sounding rocket section. Such data make it possible to create a model of the future payload heat transfer.

Previous REXUS experiments included single point temperature measurements [10, 11] focusing on local effects rather than on heat transfer phenomena. Such temperature profiles, while essential for an experiment, are of no use for future experiment designers, since temperature distribution depends not only on the heat source, but also on the experiment's geometry and materials. While it is possible to estimate heat flux computationally, this requires solving the inverse heat transfer problem, which has proven problematic [6]. Currently only rough estimates of temperature ranges are provided for the REXUS rocket [7], which can lead to overdesign due to margins being larger than actually needed [12]. Results obtained during the HEDGEHOG REXUS Project flight campaign in early March 2019 in Esrange Space Center, Kiruna, Sweden can help solve this problem.

2. Methods

2.1 Vibrational part

The first part of the experiment focused on vibrational phenomena. A system of 10 cantilever beams was designed to amplify vibrations of a specific frequency (see Fig 3.). This system allowed for increasing the accuracy of the accelerometer measurement by means of mechanical amplification of the signal. The goal of this part of the experiment was to verify whether the signal amplification on each beam (at each frequency) corresponds to the level of acceleration measured on the rocket.





Fig. 3. The vibrational part of HEDGEHOG REXUS Project

The first longitudinal eigenfrequency of the rocket was identified as 645 Hz, with the use of the modal analysis methodology for sounding rockets developed by Gierse et al [13]. Several lateral (due to bending of the rocket) eigenfrequencies were also identified, but had not been considered during the design of amplifiers, as the accelerometers used were uniaxial, insensitive in the lateral direction of the rocket. The choice of beams' frequencies was driven by two factors: the desire to cover a typical range of REXUS rockets eigenfrequencies of 300 Hz to 800 Hz [13], and focusing on the longitudinal eigenfrequency to verify sensitivity. Beams were tuned to have the following frequencies: 345 Hz, 405 Hz, 500 Hz, 550 Hz, 615 Hz, 625 Hz, 631 Hz, 643 Hz.

The reference piezoelectric accelerometer with 2.5 kHz measurement frequency, ± 50 g range and 0.05 g inaccuracy was placed directly on the inner side of the rocket surface. Measurements were performed during the ascent part of the flight, after motor burnout (see Fig. 1). Each cantilever beam was tuned to a specific eigenfrequency. This was achieved by moving an aluminium weight cube along the length of the beam. The position of the cube was determined by means of modal analysis (see Fig. 4), after which it was confirmed by modal testing with an impact hammer. When positioning the weight cube, with 1 mm as the distance choice precision, the accuracy of tuning is 5 Hz; however, the impact hammer test enables a more accurate determination of the beam frequency (1 Hz). At each cube, a uni-axial MEMS accelerometer was placed to measure vibrations of the beam (see Fig. 3) with 2.5 kHz measurement frequency and 0.03 g inaccuracy.

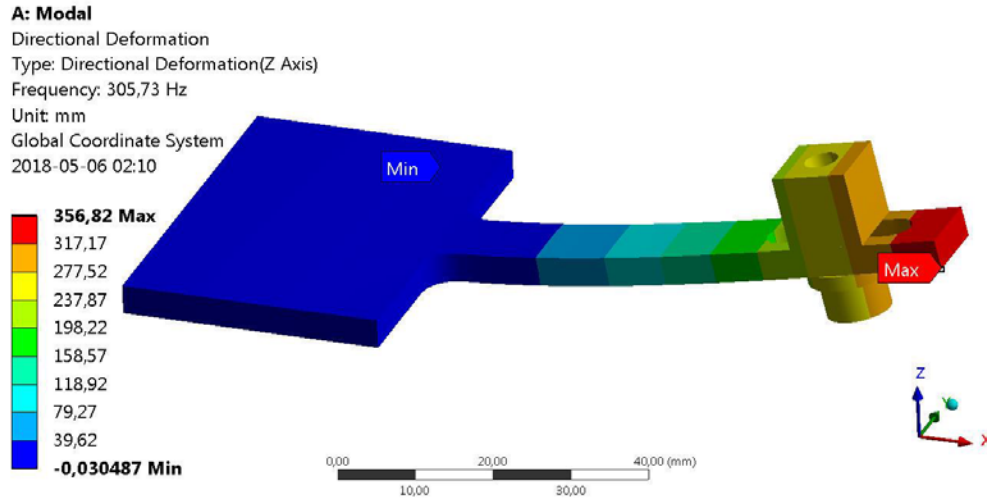

Fig. 4. Finite element modal analysis of a single tunable beam.

2.2 Thermal part

The second part of the experiment focused on heat transfer phenomena. An aluminium cylinder covered with a thick layer of insulation (3M Thinsulate [14]) was constructed. The design with necking (see Fig. 5) forces homogenous heat flow, creating a simple 1D flow situation which facilitates model fitting. At each end of the necking a thermocouple was placed a manner that would maximally diminish any obstruction of the heat flow. The massive inner part acted as a heat tank holding a specific amount of thermal energy.

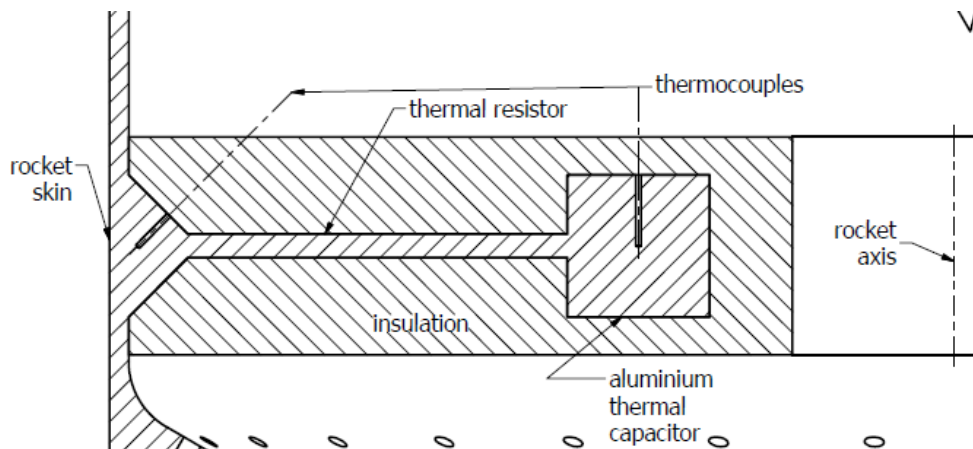

Fig. 5. Heat flux measurement device.

An analysis was performed to allow precise dimensioning of the device, which itself was a series of concentric aluminium rings, each of different dimensions and purpose. These included:

- thermal resistance, “necking”, marked as L1;
- thermal capacitance, “container”, marked as L2;
- (empty) cable feedthrough (min $\square 30$ mm according to [7]), marked as D1;

all of which are presented in Fig. 6. They were limited by the inner diameter of the REXUS module: $\square 174$ mm [7]. Special consideration was given to ensuring the best possible proportions between D1, L2 and L1, with respect to both scientific results and machinability.

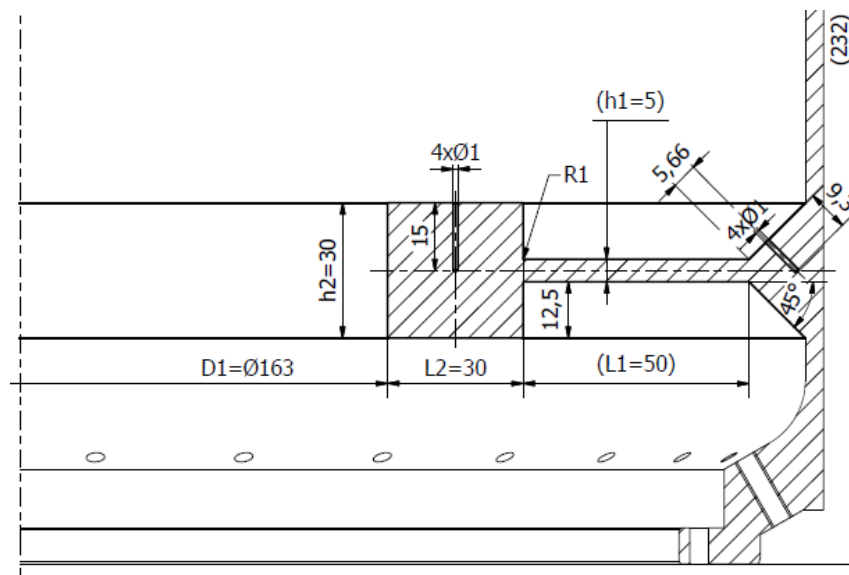

Fig. 6. Dimensions of the heat flux measurement device.

The transferred heat flux Q [W/m^2] can be calculated using Fourier Law [15]:

$$Q = k \cdot \Delta T / L \quad (1),$$

where: k is the thermal conductivity of material [$\text{W}/(\text{m}\cdot\text{K})$], ΔT is the temperature difference [K], and L is the length of the necking [m]. While other values are constant, ΔT can be calculated by measuring temperatures with thermocouples.

Four type T thermocouples were used along with the LTC2983HLX - a measurement system with cold junction compensations. Cold junction was provided internally by LTC2983HLX with the use of PT100 RTD mounted below the place where thermocouples' cables had been soldered. Thermocouples' measurements were acquired with a frequency of 1 Hz. An analysis with LTC Testbench software [16] yielded an 0.23 °C inaccuracy of the system. The heating of thermocouples and RTD was neglected. This, in return, provided a heat flux inaccuracy of 500 W/m^2 .

The heat flux was assumed to be axisymmetric on the rocket skin. This assumption is justified due to the rocket spinning (around 4 Hz) throughout most of the flight. Furthermore, uniform distribution of the heat flux on the rocket skin was assumed. This is justified for the payload compartment of a sufficiently long sounding rocket, as it was in this case [6].

3. Results and Discussion

3.1 Vibrations during the flight

More than 2.5 million samples were recorded during a 1100 second flight on each of the 10 cantilever beams and on the reference accelerometer attached to the rocket. Fig. 7. presents raw accelerations during the whole rocket flight from the 645 Hz cantilever beam. Key flight events were marked. These correspond with the flight events presented in Table 1. Please, note that acceleration was amplified by the cantilever system. Assuming the system is linear, the actual acceleration level can be calculated.

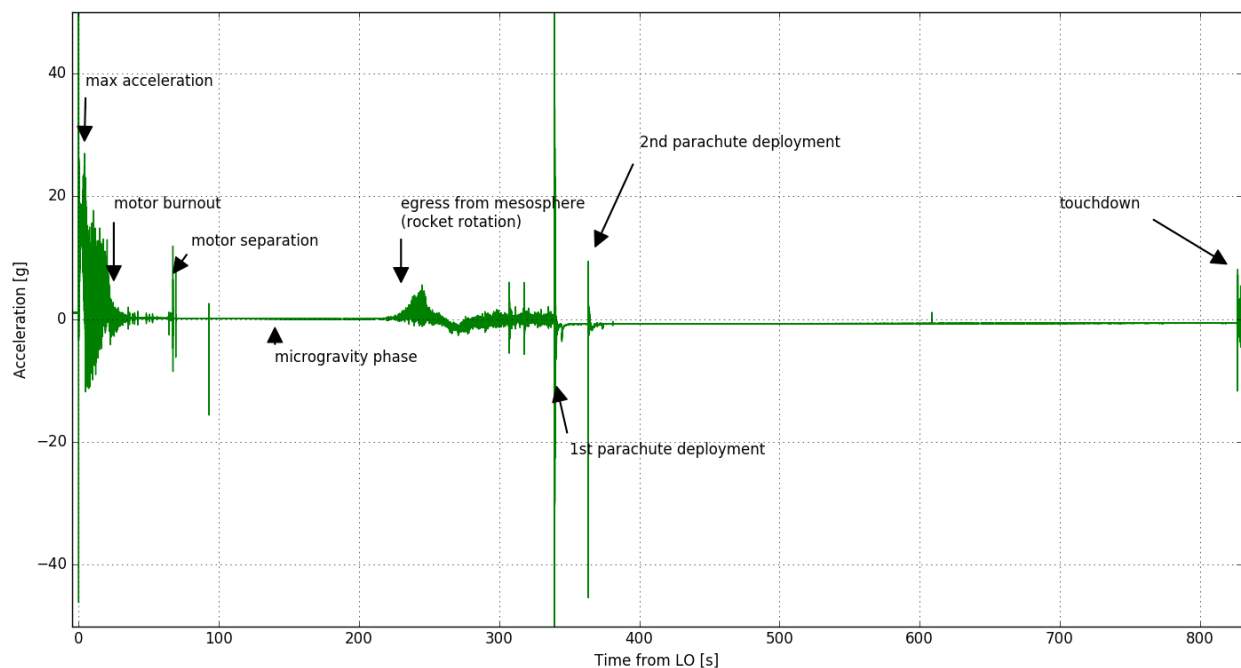

Fig. 7. Amplified vibrations from the 645 Hz cantilever beam with marked flight events.

A few previously unstudied phenomena were detected. Firstly, it was proven that vibrations occur before the liftoff. This is because the liftoff signal mark is triggered by the umbilical cord rupture. Exact timing was measured as -0.05 s. This is presented in Fig. 8.

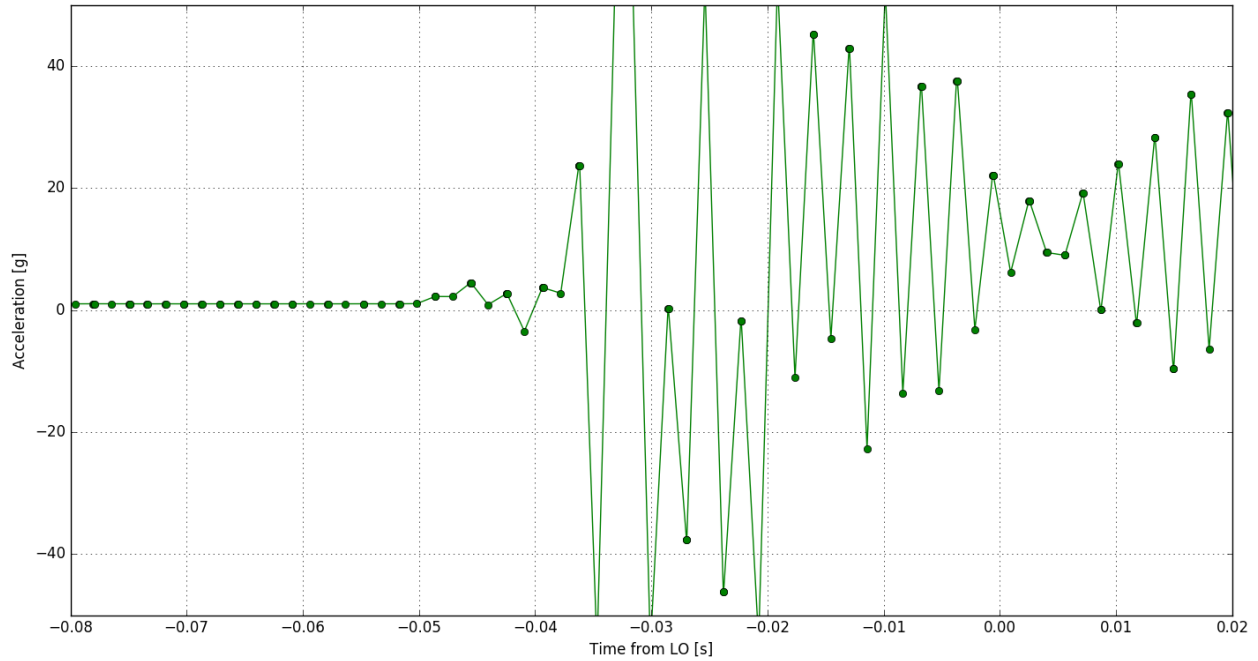

Fig. 8. Amplified vibrations from the 645 Hz cantilever beam.

Secondly, some rapid (less than 0.1 s) jerks were detected that were matched with parachute deployments. Finally, the level of microgravity was measured using amplified cantilever vibrations. The microgravity profile is presented in Fig.

9.

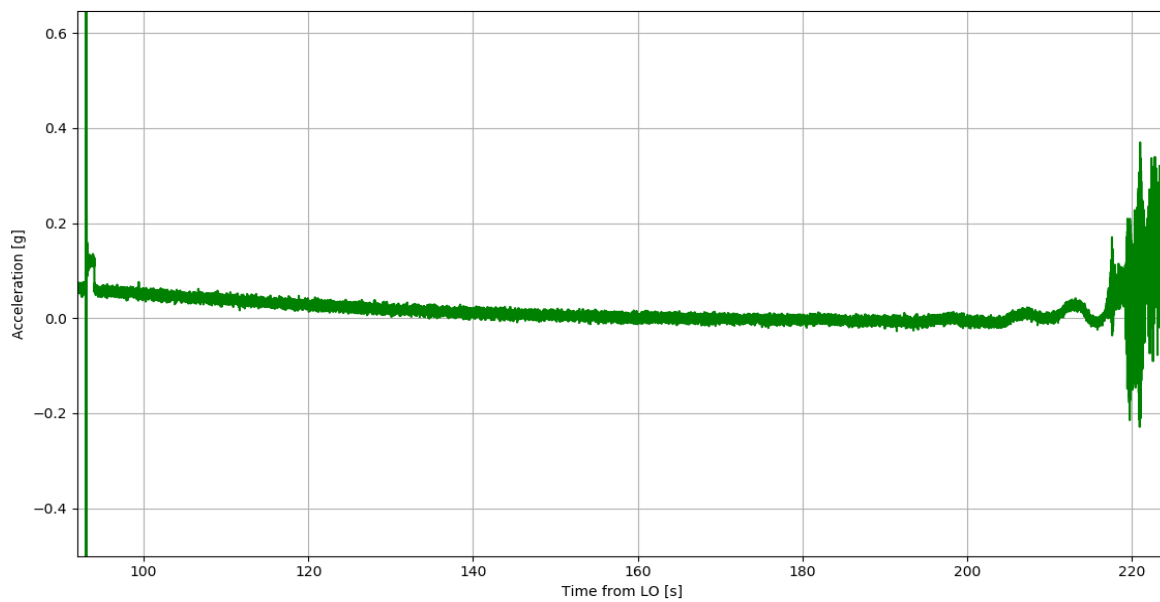

Fig. 9. Microgravity profile during the apogee phase.

The quality of the microgravity measured is of the order of measurement accuracy (0.05 g) only for 20 seconds (between 140 s and 180 s). Before that phase, the rocket's slow rotation contributes to around 0.1 g. After 180 s, the rocket enters a flat spin. This corresponds to results by Stamminger [17].

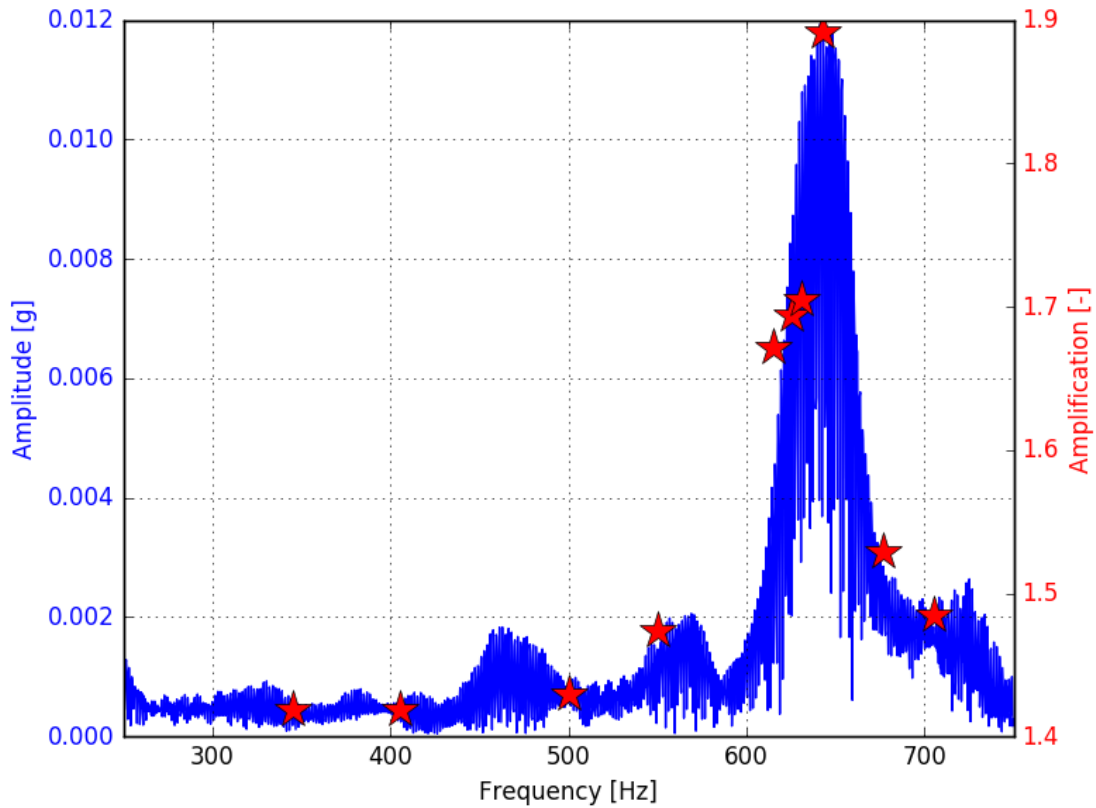

Fig. 10. Cantilever amplifications versus the amplitude of vibrations in various frequencies during flight.

A Fourier analysis of vibrations after motor burnout was performed during the flight. Results are presented in Fig. 10 (blue). The amplification of each cantilever beam was calculated as a ratio between the cantilever accelerometer max value in that phase and the reference accelerometer max value in that phase. The resulting values are presented in Fig. 10 (red). This proves that the overall amplification of the cantilever system is around 1.44. In frequencies close to the natural frequency of the rocket (645 Hz) cantilever indications are higher, which corresponds with the actual vibration level. This proves the system's selectivity and its filtering capabilities.

3.2 The heat flux measurement

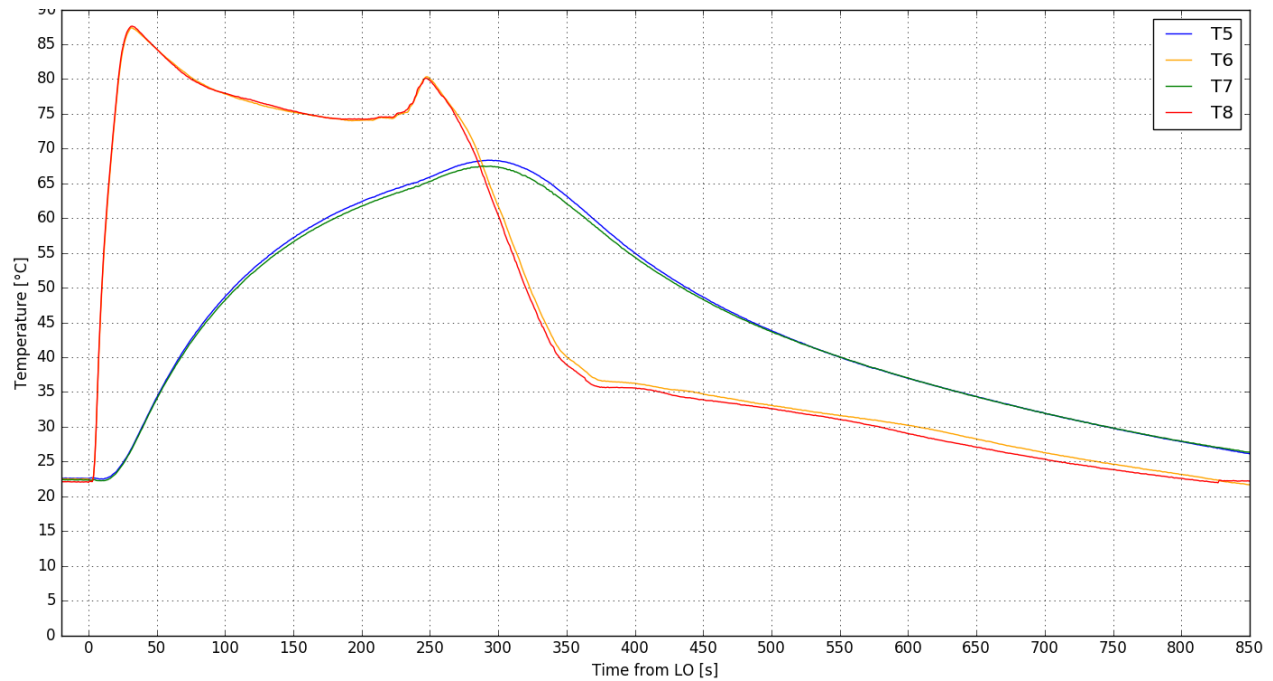

Fig. 11. Temperature measurement profiles.

Temperatures were measured with T type thermocouples placed as described in section 2.2. The results are presented in Fig. 11. Data was obtained from 2 pairs of thermocouples and two ambient temperature sensors: one located next to voltage converters and the other close to the skin of the rocket. Two distinct curves can be noticed: T6 (orange) and T8 (red) - outer thermocouples, T5 (blue) and T7 (green) - inner thermocouples. With the use of a formula (1), one is able to calculate the heat flux density at any time. This is presented in Fig. 12.

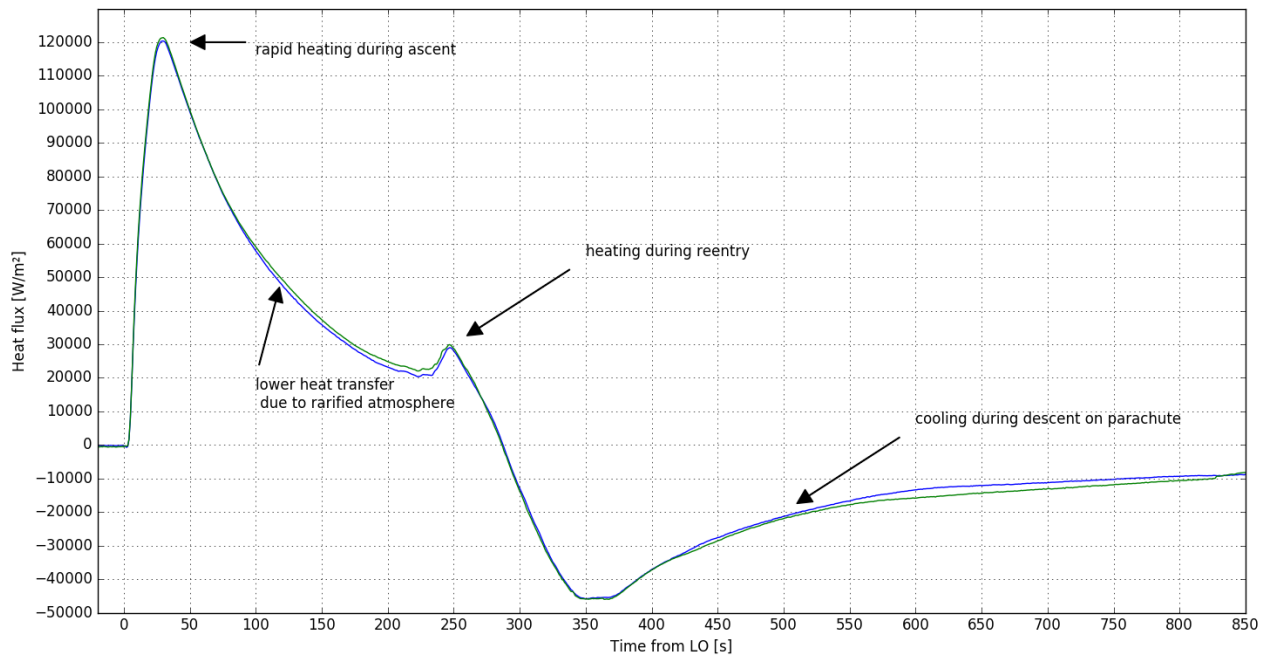

Fig. 12. Heat flux temporal profile.

Careful consideration of certain limitations is needed when applying the above presented results in the future sounding rocket experiments' design. Schmidlin [18] discussed sounding rockets' repeatability. Jewell et al. [19] proved computationally and experimentally that heat transfer of a sounding rocket depends highly on: rocket geometry (especially nosecone), flight dynamics (velocity, acceleration), flight trajectory, weather (air pressure and wind speed). While it is generally not possible to recalculate the above presented profiles with regard to any other given flight conditions; typically, all REXUS launches display similarities [7]. The rocket geometry is constant. The flight trajectories depend on payload mass; however, the initial, and crucial for heat transfer, accelerated trajectory is very similar (see Fig. 13). Thermal data from the SMARD experiment (REXUS-18) [10] was used to compute heat flux [6]. Results of these calculations are similar to those presented here (see Fig. 8.).

Hu et. al. [20] discussed sounding rocket structural dynamics and proved computationally as well as experimentally that natural frequencies drive the rocket's dynamic behaviour. As REXUS modules have strict mass and shape limitations [7], the first natural frequency (bending) of the rocket will stay constant between flights [13]. The applicability of the presented results for future REXUS flights requires confirmation.

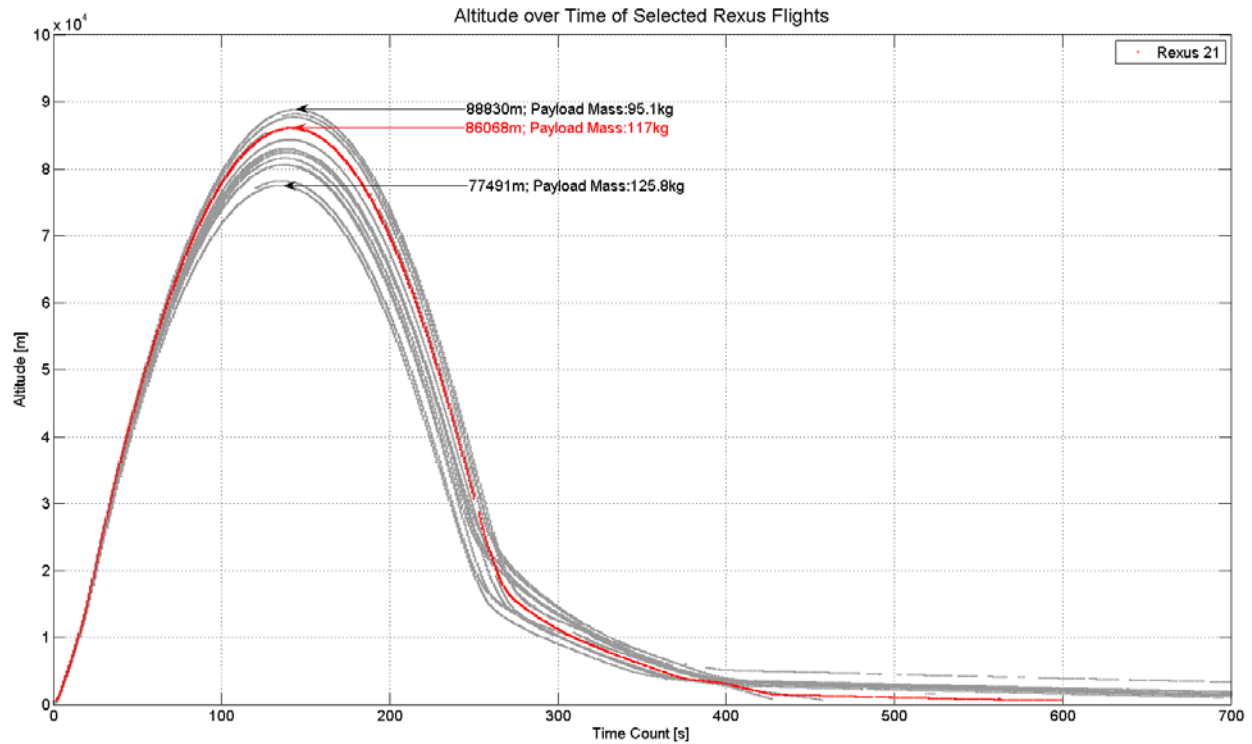

Fig. 13. Dependence of altitude of REXUS flights on payload mass [7].

4. Conclusions

HEDGEHOG REXUS Project measured interesting properties of sounding rocket flight environment. Previously undescribed phenomena were discovered, such as: rapid jerks before liftoff. Quantitative description of parachute deployment jerks was provided.

Additionally, the cantilever beam system was verified as a mechanical filter and an amplifier for vibrations. This enables its application in future flights. Implementing this system increases the accuracy of accelerometer measurements.

Finally, the temporal profile of heat flux on rocket skin was calculated. While some assumptions have to be considered when applying the data in future REXUS flights, this can be useful information for payload designers. A comparison between HEDGEHOG experimental data and simulations described in [6] is necessary. These will be further studied and published in subsequent journal papers.

Acknowledgements

The authors would like to express their gratitude to reviewers of this paper for thorough insight and numerous comments that improved the quality of this work. All calculations were carried out at the Academic Computer Centre in Gdańsk.

Declaration of competing interest

The authors of the manuscript “Preliminary results from HEDGEHOG REXUS Project – a sounding rocket experiment on accelerations, vibrations and heat flow”, Adam Dąbrowski, Karol Pelzner, Szymon Krawczuk, Jacek Goczkowski and Agnieszka Elwertowska declare no conflict of interest.

References

- [1] REXUS-BEXUS programme, <http://rexusbexus.net/rexusbexus-programme/> Read 2020-06-05.
- [2] H. Mao, T. Sinn, M. Vasile, G. Tibert, Post-launch analysis of the deployment dynamics of a space web sounding rocket experiment, *Acta Astronaut.* 127 (2016) 345-358, <https://doi.org/10.1016/j.actaastro.2016.06.009>.
- [3] M. R. Röbner, M. S. Müller, T. C. Buck, A. Koch, Broadband light source for fiber-optic measurement system in spaceborne applications, *Acta Astronaut.* 70 (2011) 95-99, <https://doi.org/10.1016/j.actaastro.2011.07.018>.
- [4] A. Boesso, A. Francesconi, ARCADE small-scale docking mechanism for micro-satellites, *Acta Astronaut.* 86 (2013) 77-87, <https://doi.org/10.1016/j.actaastro.2013.01.006>.
- [5] A. Stamminger, J. Turner, M. Hörschgen, W. Jung, Sounding rockets as a real flight platform for aerothermodynamic CFD validation of hypersonic flight experiments. Proceedings of the *Fifth European Symposium on Aerothermodynamics for Space Vehicles* 563 (2005) 431, ESA SP-563.
- [6] A. Dąbrowski, L. Dąbrowski, Inverse heat transfer problem solution of sounding rocket using moving window optimization, *PLoS One* 14 (2019) e0218600, <https://doi.org/10.1371/journal.pone.0218600>.
- [7] REXUS Manual, <http://rexusbexus.net/rexus/rexus-user-manual/> Read 2020-06-05.
- [8] T. Lyubimova, A. Ivantsov, Y. Garrabos, C. Lecoutre, D. Beysens, Faraday waves on band pattern under zero gravity conditions. *Phys. Rev. Fluids* 4 (2019) 064001, <https://doi.org/10.1103/PhysRevFluids.4.064001>.



- [9] T. Lyubimova, A. Ivantsov, Y. Garrabos, C. Lecoutre, G. Gandikota, and D. Beysens. Band instability in near-critical fluids subjected to vibration under weightlessness. *Phys. Rev. E* 95 (2015) 013105, <https://doi.org/10.1103/PhysRevE.95.013105>.
- [10] M. Grulich, A. Koop, P. Ludewig, J. Gutsmedl, J. Kugele, T. Ruck, I. Mayer, A. Schmid, K. Dietman, SMARD-REXUS-18: Development and verification of an SMA-Based CubeSat solar panel deployment mechanism Proceedings of the 22nd ESA Symposium European Rocket & Balloon Programmes and Related Research (2015), ESA SP-730.
- [11] P. Nannipieri, G. Meoni, F. Nesti, E. Mancini, F. Celi, L. Quadrelli, E. Ferrato, P. Guardati, F. Baronti, L. Fanucci, A. Signorini, T. Nannipieri, Application of FBG sensors to temperature measurement on board of the REXUS 22 sounding rocket in the framework of the U-PHOS project, Proceedings of the 2017 IEEE International Workshop on Metrology for AeroSpace (MetroAeroSpace) (2017) 462-467, <https://doi.org/10.1109/MetroAeroSpace.2017.7999618>.
- [12] A. Gómez-San-Juan, I. Pérez-Grande, A. Sanz-Andrés, Uncertainty calculation for spacecraft thermal models using a generalized SEA method, *Acta Astronaut.* 151 (2018), 691-702, <https://doi.org/10.1016/j.actaastro.2018.05.045>.
- [13] A. Gierse, S. Krämer, D. J. Daab, J. Hessel, F. Baader, B. S. Müller, T. Wagner, G. Gdalewitsch, E. Plescher, L. Pfütenreuter, Experimental in-flight modal-analysis of a sounding rocket structure, Proceedings of the 21st ESA Symposium on Rocket & Balloon Programmes and Related Research (2013), ESA SP-721.
- [14] Z. Fuli, Application and Development of Thinsulate Insulation, *Tech. Text. Int.* 2 (2003) 12.
- [15] T. L. Bergman, A. S. Lavine, F. P. Incropera, D. P. DeWitt, Fundamentals of Heat and Mass Transfer, 8th ed., Wiley, 2018.
- [16] Linear Technology, LTC2983, <https://www.analog.com/en/products/ltc2983.html> Read 2020-06-05.
- [17] A. Stammering, Re-entry analysis of research rockets payloads, Proceedings of the 62nd International Astronautical Congress (2012) 764-770.
- [18] F. J. Schmidlin, Repeatability and measurement uncertainty of the United States meteorological rocketsonde, *J. Geophys. Res.*, 86 (1981) 9959-9603, <https://doi.org/10.1029/JC086iC10p09599>.
- [19] J. S. Jewell, J. H. Miller, R. L. Kimmel, Correlation of HIFiRE-5a flight data with computed pressure and heat transfer, *J. Spacecr Rockets*, 54 (5) (2017), 1142-1152, <https://doi.org/10.2514/1.A33725>.

- [20] H. W. Hu, Y. C. Wang, W. J. Lu, Structural dynamic analysis of a sounding rocket during the liftoff, *J. Aeronaut. Astronaut. Aviat. Ser.*, 41 (2), 111-120.