

LECH HASSE, JANUSZ SMULKO

Gdańsk University of Technology
Faculty of Electronics, Telecommunication and Informatics
Department of Optoelectronics and Electronic Systems
Poland, e-mail: jsmulko@eti.pg.gda.pl

QUALITY ASSESSMENT OF HIGH VOLTAGE VARISTORS BY THIRD HARMONIC INDEX

High voltage varistors that consist mainly of grained ZnO have to be tested before assembling into a surge arrester. The existing methods demand a usage of high voltages and intensive currents that is inconvenient, destructive and needs extensive power consumption. Additionally, these methods require metallization of the prepared varistor structures that increases costs. We propose another method of varistor quality assessments by a third harmonic index measurement at relatively low voltage range. In this experimental study it has been proved that the proposed procedure can be applied successfully for preliminary selection of the tested structures.

Keywords: varistor, nonlinearity, quality assessment

1. INTRODUCTION

Varistors are widely used in surge arresters, in electrical and electronic applications. Their usage limits overvoltage disorders caused by lightning or other electrical shocks. A varistor can be modelled in the simplest way as a parallel connection of a nonlinear resistor R and a capacitor C (Fig. 1) [1]. High quality varistors are characterised by strongly nonlinear resistance that depends on technology and materials used within preparation process. These electronic elements are produced from a mixture of ZnO grains and some additives that significantly influence their properties and are kept confidential by producers. Typically, capacitance C doesn't exceed hundreds of nF and is responsible for varistor impedance at frequencies above hundreds of Hz and at low voltage range.

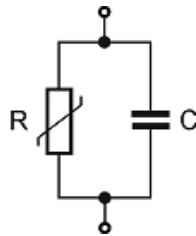

Fig. 1. Varistor equivalent circuit.

The DC current-voltage characteristic of a varistor has three distinguishable regions: prebreakdown, breakdown and saturation (Fig. 2) [2]. A varistor behaves as a highly resistive resistor ($\sim 10^9 \Omega$) at low voltage region. At breakdown region the DC current I is exponentially proportional to the applied DC voltage U :

$$I = kU^\alpha. \quad (1)$$

The exponent α depends on a type of boundary junctions that exist between the grains. Varistors saturate at higher voltages and their resistance doesn't exceed tens of ohms in this voltage range.

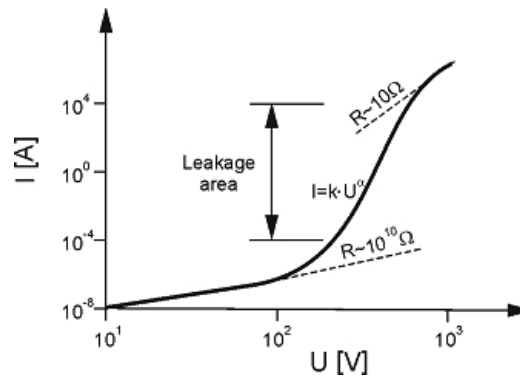

Fig. 2. Varistor current-voltage characteristic [2].

In practice, varistors should exhibit high values of a parameter α . There are good, low nonlinear and linear junctions between the ZnO grains. The exponent $\alpha > 30$ indicates the most required grain contacts. The low nonlinear contacts exhibit $\alpha \approx 10$. These various contacts are discriminated by their current-voltage characteristic (Fig. 3) [3].

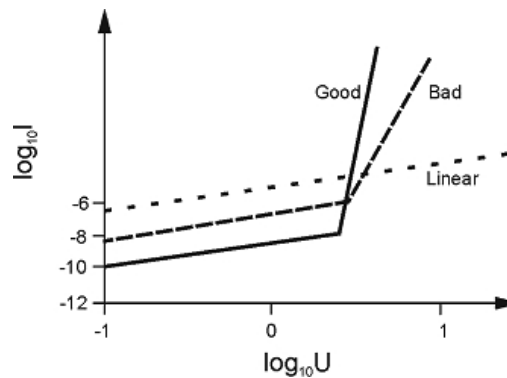

Fig. 3. Current-voltage characteristics of the distinguished types of boundary junctions between ZnO grains [3].

A real varistor is a mixture of various grains and its outcome characteristic depends on amount of different grain types that exist in its structure. The widespread presence of linear or weakly nonlinear grain contacts decreases the value of exponent α and diminishes desirable nonlinear varistor characteristic at its relatively low voltage region, up to $2 \div 4$ hundreds volts. Thus, varistors quality can be assessed by linearity of their DC characteristics in the mentioned voltage range. A third harmonic component can be utilized as a nonlinearity measure of the DC characteristic in this region. Therefore, dangerous and energy consuming testing at high voltage range can be replaced by the more convenient method.

In this experimental study, we present results of the third harmonic component (THC) measurements in the selected varistors types. THC is a harmonic signal of frequency three times higher than the harmonic signal that stimulates a tested varistor. This component is generated in a nonlinear varistor structure.

The applied measurement system and usefulness of the proposed method for varistor testing at their fabrication stage is considered in detail.

2. INDUSTRIAL STANDARDS FOR VARISTOR TESTING

Varistors endurance and quality has to be assessed at the final stage of their production. Industrial standards predict leakage current measurements at DC voltage about 400 V. The leakage DC current doesn't exceed hundreds of μA in the properly prepared samples. Too high value means rejection of the tested specimen. Another method applies high voltage impulses that cause intensive current flows. A current flows mainly through narrow paths comprised of grains with linear (ohmic) junctions. High current density and intensive heating there causes irreversible destruction of the tested varistor.

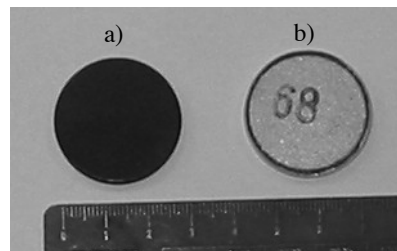

Fig. 4. Varistors: a) ZnO structure after being fired in a stove, b) with the metalized contacts.

Both methods are used when a grained structure of ZnO has metalized contacts (Fig. 4). It means that elimination of the defective specimen needs a production of the expensive contacts when compared with a relatively small cost of ZnO material. Therefore, it is valuable to propose another method of ZnO structure selection at a stage before printing metalized contacts.

We suggest to measure THC at small currents that flow through the varistor excited by a harmonic signal at voltage amplitude up to 100 V. Such tests are non-destructive but demand a

measurement system that can precisely measure a third harmonic component being at least five orders lower than the excitation signal. The specimens can be preselected and the defective ones excluded from further processing.

3. THIRD HARMONIC MEASUREMENT SETUP

The measurements were performed in a specially prepared setup that consisted of a head with five contact electrodes for each side of a varistor (Fig. 5), a third harmonic meter and a computer that controlled data acquisition process (Fig. 6). The springing contact electrodes gripped firmly the sample. Additionally two trusses at the bottom of the head centred position of the sample to make measurement results possibly repeatable.

The stimulating harmonic signal with frequency 10 kHz was applied. The non-linearity of the tested varistor with impedance Z_v is determined by measurement of a third harmonic component at 30 kHz. Figure 7 shows the general technique of THC determination [4, 5]. A THC value is equivalent to a no-load voltage U_3 in series with the tested varistor having impedance Z_v :

$$U_3 = U_m \left(1 + \frac{|Z_v|}{R_L} \right), \quad (2)$$

where the voltage U_m is measured across a load resistance R_L . The necessary computation to obtain U_3 value was done by the meter.

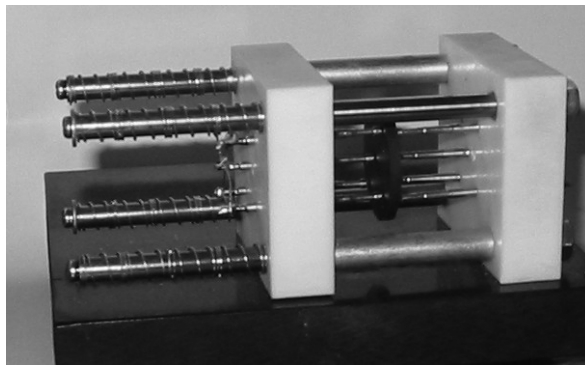

Fig. 5. Measurement head with multiple contact electrodes that grip the tested ZnO spacemen.

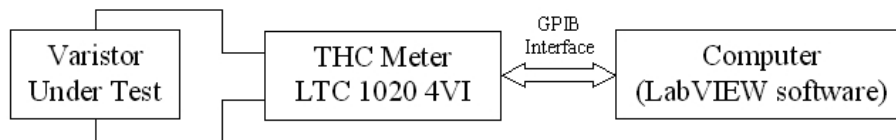

Fig. 6. A block diagram of the measurement system.

The meter consists of a generator, together with low-pass and high-pass filters that separate an excitation signal and a third harmonic component. It was found that only a third harmonic has a non-negligible level in the tested varistors and all higher harmonics have not to be taken into account. We can assume a residual system non-linearity as no higher than -140 dB. The meter was controlled by computer through the GPIB interface. A virtual instrument, prepared in LabVIEW software, controlled serial measurements within the established DC voltage range, up to one hundred volts [6]. Measurements were repeated several times after the same established period to obtain averaged values that were saved in a computer memory. The meter automatically changed its range when necessary.

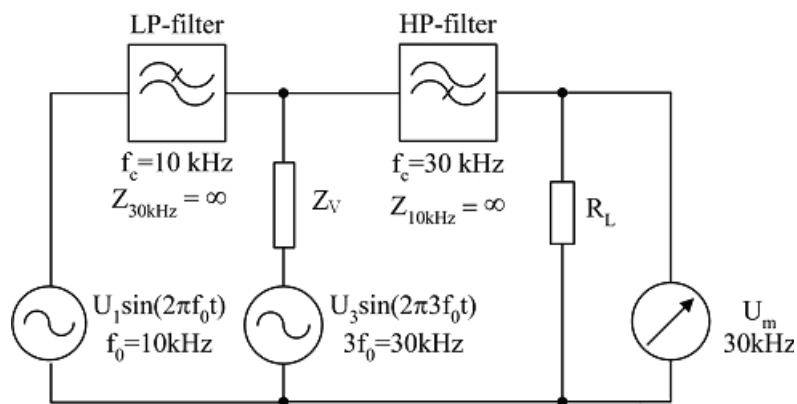

Fig. 7. A simplified diagram of the third harmonic meter.

The measurement system enabled to measure a third harmonic voltage U_3 even within the range of hundreds μ V. The results of measurements were repeatable. When a position of the tested varistor in the measurement head (Fig. 5) was changed by its rotation the maximal difference between the results of U_3 measurements didn't exceed 4%. This means that we can apply the prepared head with five electrodes for the proposed measurements of varistor samples without metalized contacts printed on their surfaces.

4. MEASUREMENT RESULTS

Three types of varistors were investigated. Each type was produced to protect against overvoltage at different threshold voltage and marked as 280V, 440V and 680V. All discs of varistors have the same diameter but the higher voltage threshold was obtained for the thicker samples. Two different batches of samples were produced for each mentioned above voltage threshold. There was a significant difference between proportions of linear and nonlinear grain junctions that were present in each batch. This difference was a result of changes introduced artificially in varistors composition and it had direct impact on their DC current-voltage

characteristics (Fig. 8). Therefore, one of the batches could be treated as a group of lower quality varistors – with higher leakage currents and more linear DC characteristics at low voltage range. We would like to investigate within all groups of the prepared varistors whether it is possible to identify their quality by the measurement of the THC at relatively low voltage only. Thus, the THC was measured up 100 V within a set of the prepared samples.

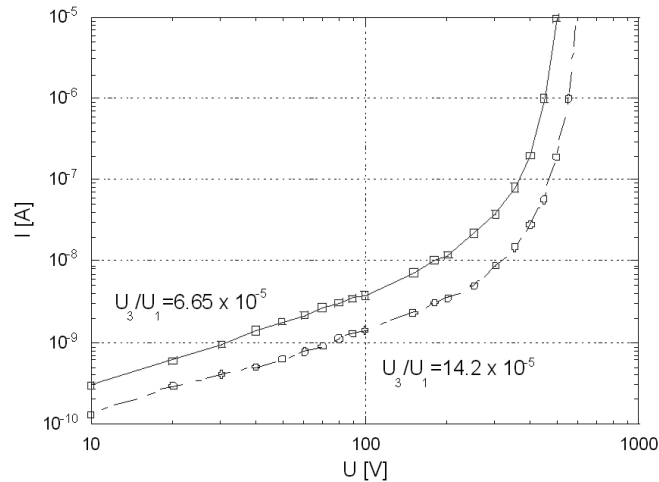

Fig. 8. DC current-voltage characteristics of two varistors, series 280V – lower quality (squares) and higher quality (circles) – and their normalized third harmonic component U_3 measured at amplitude $U_1 = 100$ V of the excitation signal.

At the first step, a third harmonic index of some specimens was measured within a voltage range $10 \div 100$ V of the harmonic excitation signal amplitude U_1 . We observed power law dependence between U_1 and the measured third harmonic component U_3 . Varistors from the higher quality batch exhibited on average lower exponent in the log-log scale with value about 2 (Fig. 9) when compared with the results observed in the lower quality batch (Fig. 10). Additionally, high quality varistors had on average larger value of the third harmonic component than measured in the latter group. This outcome is in a good agreement with the observed differences in DC current-voltage characteristics for both batches. A more linear DC characteristic at low voltage range for lower quality batch means lower THC that begins to rise faster (higher exponent) when compared with behaviour observed for higher quality specimens.

At the next step, the measurements were made within a set of about hundred specimens for each batch, separately for all three voltage series: 280V, 440V and 680V. Figure 11 presents the statistical measurement results for the series 280V. There is a visible separation between high and low quality groups. The high quality batch exhibits on average significantly higher third harmonic component value. A difference between these averaged values is up to 30%.

For the next series 440V, the less evident difference was observed (Fig. 12). Even smaller difference was identified for the series 680V. This result arises from the alterations in their DC

current-voltage characteristics. Series that are prepared for higher voltages start to bend their DC characteristic at higher voltages. It means that the value of $U_1 = 100$ V seems to be proper only for a series that was prepared for the lowest threshold voltage 280V. It is worth to mention that even higher voltage U_1 doesn't increase significantly power consumption during tests. Even an increase up to 400 V shouldn't cause current flow over $1 \mu\text{A}$ (Fig. 8).

Another problem of the proposed method of varistors diagnostics that should be considered is a time interval that is necessary for acquiring repeatable measurement results. When varistors didn't have metalized contacts on their surfaces time of measurement extends up to a few seconds. Time decreases significantly below this period when printed metal contacts were produced before measurement.

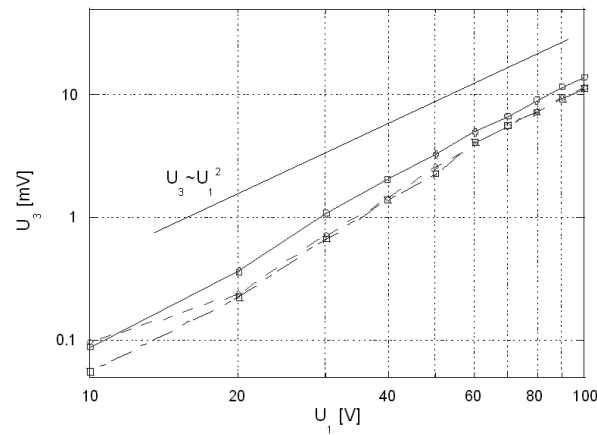

Fig. 9. Dependence between an amplitude U_1 of harmonic excitation signal and the normalized third harmonic component U_3 for the three randomly chosen varistors of higher quality, series 280V.

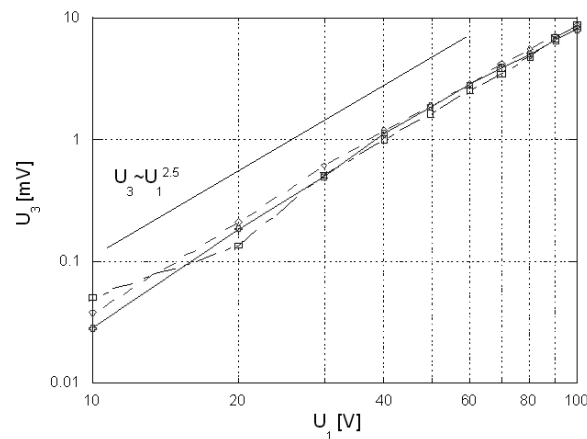

Fig. 10. Dependence between an amplitude U_1 of harmonic excitation signal and the normalized third harmonic component U_3 for the three randomly chosen varistors of lower quality, series 280V.

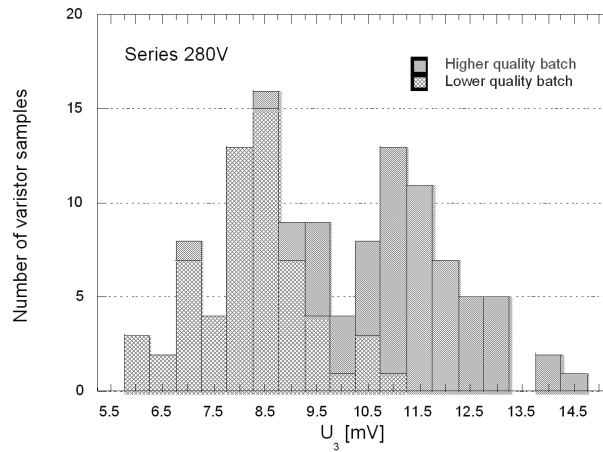

Fig. 11. Distribution of third harmonic component U_3 observed at excitation signal of amplitude $U_1 = 100V$ within low and high quality varistor batches, achieved for series 280V; the striped bar starts at the end of the checked one.

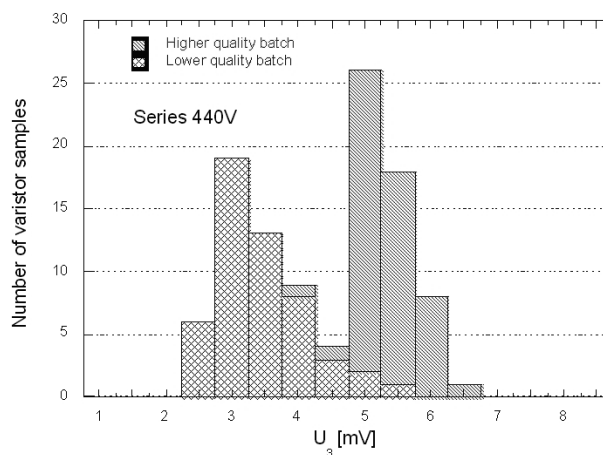

Fig. 12. Distribution of third harmonic component U_3 observed at excitation signal of amplitude $U_1 = 100V$ within low and high quality varistor batches, achieved for series 440V; the striped bar starts at the end of the checked one.

5. CONCLUSIONS

A new method of varistor quality and endurance detection was proposed. The technique that applies THC measurements for varistors quality assessment was investigated using a prepared and described measurement setup. The detailed results of measurements for various varistor types have been presented as well.

We conclude that this method can be successively applied for varistor specimens testing at the production stage before the metalized contacts were printed on their structures. An amplitude $U_1 = 100$ V of a harmonic excitation signal is sufficient to distinguish between high and low quality varistors prepared for the threshold voltage 280 V. Then the differences in THC values between both groups of varistors were up to 30%. Other varistors series needed higher excitation signal to achieve sufficiently higher difference of this parameter.

This method could be applied for quality detection of other grainy materials that are subject of thorough research if they exhibit sufficient nonlinearity [7, 8].

ACKNOWLEDGEMENTS

This study is supported by the Polish Ministry of Science and Higher Education, grant N511 004 31/0529.

REFERENCES

1. Chrzan K. L.: *Overvoltages limiter for high voltages*, Wrocław, Dolnośląskie Wyd. Edukacyjne 2003. (in Polish)
2. Eda K.: "Destruction mechanism of ZnO varistors due to high currents", *J. Appl. Phys.*, vol. 56, no. 10, 1984, pp. 2948–2955.
3. Modline F. A., Boatner L. A., Bartkowiak M., Mahan G. D., Wang H., Dinwiddie R. B.: "Influence of ceramic microstructure on varistor electrical properties", *Ceramic Trans., The American Ceramic Soc.*, vol. 100, 1999, pp. 469–491.
4. *Reliability testing of nominally linear components by measuring third harmonic distortion*. CLT 10. Component linearity test equipment. Application note of Danbridge, 2002.
5. Fagerhold P. O., Ewell G. J.: "Third harmonic testing", *15th European Passive Components Symposium CARTS-Europe*, 2001, pp. 221–231.
6. LabVIEW Code Interface Reference Manual. National Instruments Corp., Austin TX, USA, September 1994.
7. Kuehl R. W.: "Reliability of thin-film resistors: impact of third harmonic screenings", *Microelectronics Reliability*, vol. 42, 2002, pp. 807–813.
8. Vandamme E. P., Vandamme L. K. J.: "Current crowding and its effect on 1/f noise and third harmonic distortion – a case study for quality assessment of resistors", *Microelectronics Reliability*, vol. 40, 2000, pp. 1847–1853.

