

# Spectroscopic wireless sensor of hematocrit level

Małgorzata Jędrzejewska-Szczerska\*, Krystian Ernest, Marcin Gnyba, Michał Sobaszek

Department of Metrology and Optoelectronics, Gdansk University of Technology, Gdansk, Poland

## Abstract

An optical method for hematocrit measurement is presented. The sensor, designed and developed by authors, consists of a spectroscopic set-up and a microcontroller. Work of the sensor is based on measurement of intensity of two selected spectral bands. Tests confirmed the ability of the sensor to determine the hematocrit level with appropriate measurement accuracy. Measurement results can be transmitted via wireless module to the monitoring centre and analysed by professionals.

Keywords: hematocrit measurement; spectroscopy; blood analysis

---

## 1. Introduction

Nowadays, the necessity to gather information of a wide range of parameters appears crucial in many fields. It requires a high number of sensors to be connected in a single network to provide easy control and acquisition of measurement data. Networks of sensor are widely-used in medicine, structural health monitoring and telemedicine. During last years optical sensors has gained popularity in those areas, because of its unique advantages: relatively simple configuration, high resolution, low thermal inertia and potentially low cost,. Furthermore, they have small size and weight. Being made from dielectric materials, there are immunity to environmental conditions, such as strong electromagnetic radiation as well as small influence on the environment [1].

One of the most important application areas of such optical sensors is monitoring of human body functions, e.g. blood parameters. Blood analysis is frequently performed for medical diagnosis because it can give important information about patient health. Nowadays, blood analysis is routinely determined in the clinic by analysis of blood samples There are several methods of blood analyzing. Unfortunately, almost all of them require either blood sampling or catheterization. Therefore, there is a great interest in optical measurement that would permit simultaneous analysis of multiple components (analytes) in whole blood without the need for conventional sample processing, such as centrifuging and adding reagents.

The purpose of our study was to design a sensor which enables measuring blood parameters at home. Continuous monitoring of blood parameters gives the possibility of better diagnosis and more rapid response to threats in the case of high risk groups. The development of cheap and versatile device makes it possible to prevent the recurrence of the disease early and effective treatment. There are few optical methods of the hematocrit (HCT) measurement. Schmitt et al. [2] used the dual-wavelength near IR-photoplethysmography. Xu et al. [3] applied optical coherence tomography for investigating the HCT value. Enejder et al. [4] used Raman spectroscopy for simultaneous measurement of concentrations of multiple analytes in whole blood. Iftimia et al. [5] demonstrated the use of the spectral domain low coherence interferometry to hematocrit measurement. However, at the present state of art optical methods of hematocrit measurement are still more complex and expensive than laboratory analysis of collected blood samples. The use of the optical technology gives unique opportunity to obtain the complex

information of absorption, reflection and scattering properties of blood. However, until now, reported optical hematocrit measurement methods have showed around 5% accuracy, even when they were performed in-vitro [6]. Study of application of optical methods of the hematocrit measurements, such as: Raman spectroscopy [7], optical coherent tomography [8], low-coherent interferometry [9] and optical spectroscopy, showed us usefulness of optical spectroscopy for hematocrit measurement. Authors decided to implement this technique in the designed sensor. The investigation of this method confirms its ability for the blood parameter control in appropriate measurement range with sufficient accuracy.

## 2. Theoretical background

### 2.1. Object of investigation

The blood components in vitro are shown in Figure 1. It can be seen that the blood can be approximately divided into: plasma and formed elements such as: erythrocytes, leukocytes, thrombocytes.

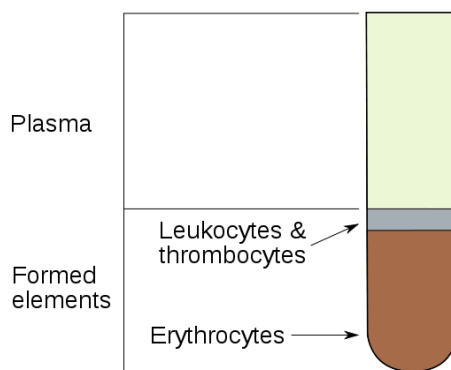

Fig.1. The blood components.

Hematocrit is ratio of packed red blood cells volume (erythrocytes) ( $V_e$ ) to whole blood volume ( $V_b$ ). It is usually expressed as a percentage or as a fraction. [9]

$$HCT[\%] = \frac{V_e}{V_b} \quad (1)$$

Hematocrit is one of the more important parameters of blood because it provides information on the total oxygen-carrying ability of patient.

The normal ranges of the hematocrit are: 39-50% for male, 35-45% for female and 30–40% for small children and babies, respectively. Any change in the value of the hematocrit of normal range indicates the possibility of a disease. When the level of hematocrit is reduced, symptoms of anemia and bleeding are usually suspected, as well as diseases of the leukemia, malnutrition, and overhydration. On the other hand, increased level of the hematocrit can be an effect of dehydration, burns, diarrhea, postpartum eclampsia, polycythemia vera. What is more important, the high level of hematocrit is also indicated as risk factors for heart and cerebral infraction because of hemoconcentration. Therefore, the hematocrit value as well as blood pressure should be controlled during the daily life as the indices of various physiological conditions in order to reduce the cardiovascular disease risk factor.

### 2.2. Sensing method

Optic sensor based on absorption spectroscopy in which radiance after passing the test substance is analyzed. In that method of spectroscopy is use infrared and visible source of light. Lambert-Beer law (see

Equation 2 describes the absorption of electromagnetic radiation passes through the partially absorbing and scattering medium.

$$\frac{I_1}{I_0} = e^{-\alpha lc} \quad (2)$$

where:  $I_1$  - light intensity after passing through the test object,  
 $I_0$  - the intensity of light falling on the test object,  
 $\alpha$  - molar extinction coefficient,  
 $l$  - way that overcomes the light in the test object,  
 $c$  - molar concentration of the absorbing substance

During the work of the sensor, absorption of optical radiation in selected spectral bands, e.g. in absorption bands of erythrocytes as well as in low-absorption bands is measured. Then data processing, described in details in Chapter 3 is carried out in order to calculate value of HCT.

### 3. Sensor design

#### 3.1. Selection of spectral bands

In order to determine spectral bands, which should be used by the sensor, spectral characteristics of blood were recorded with use of wide-band spectrometer. Results were compared with data obtained from literature.

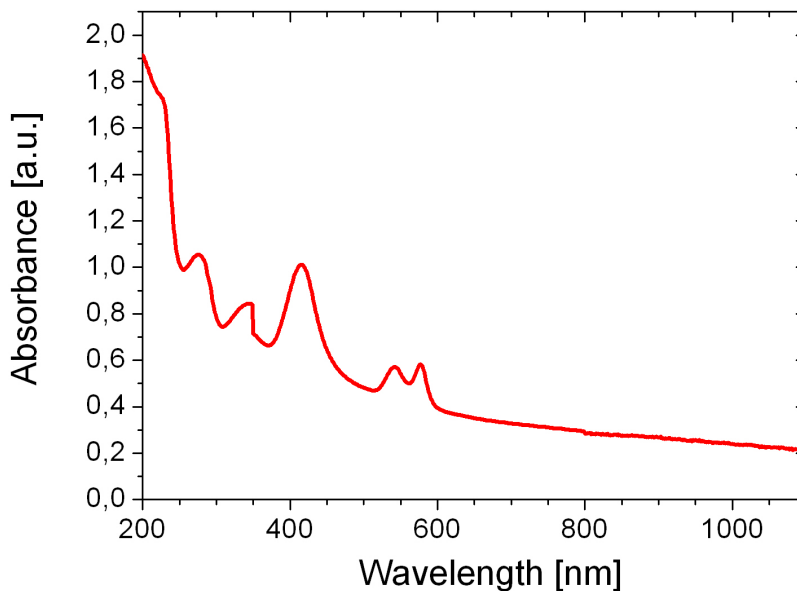

Fig. 2 Absorption of nonoxygenated whole blood as a function of light wavelength.

Analysis of literature and experimental studies enabled identification of two wavelengths as useful for determining the absorbance of blood sample: 880 nm as measuring wave and 570 nm as a reference signal attenuation of the entire system.

Wavelength 880 nm is a measuring signal according to Figures 2 and 3 where it can be seen that the coefficients for hemoglobin (Hb) nonoxygenated and oxygenated are at the same level, 570 nm wavelength is



most absorbed by morphotic components of blood. By the use of optical signals measured at this wavelengths and using Equation 3 it is possible to estimate the hematocrit value.

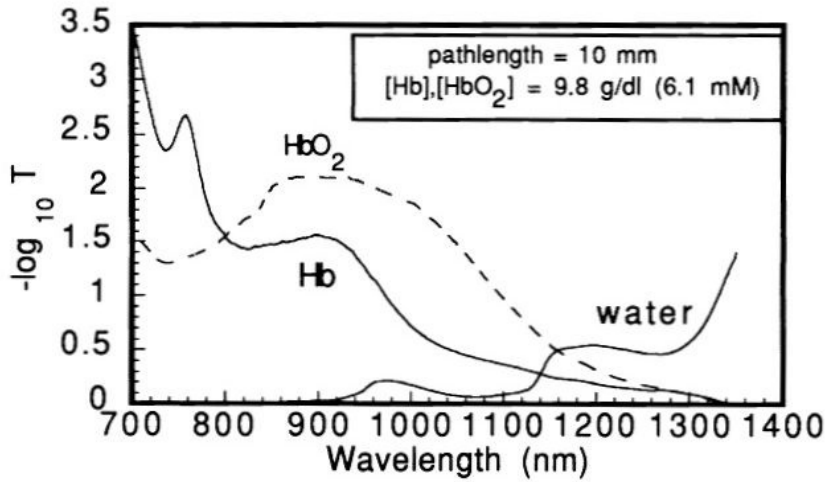

Fig. 3 Absorption of light by hemoglobin; Hb - nonoxygenated, HbO<sub>2</sub> - oxygenated [10]

$$HCT = \frac{c^{570} A^{570}}{c^{570} A^{570} + c^{880} A^{880}} \quad (3)$$

where:

$A^{880}, A^{570}$  - absorbance for wavelengths 880 nm and 570 nm respectively,  
 $c_{880}, c_{570}$  - calibration coefficients for wavelengths 880 nm and 570 nm respectively.

### 3.2. Set-up of the measurement system

In Figure 4 block diagram of the optic sensor working in transition mode is shown. There is two LED sources of light 570 nm and 880 nm. Light transmitted through the blood sample is detected by the photodiode and then detected the signal is amplified. The measurement signal from the sensor is sampled in microcontroller A/D converter.

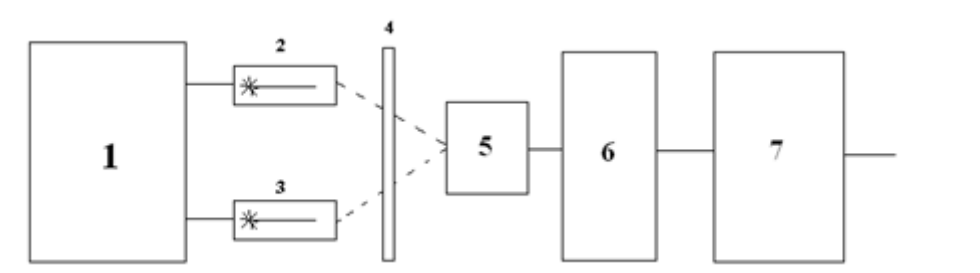

Fig. 4. Block diagram of the optic sensor: (1) light source control system (2) 570 nm source light (3) 880 nm source light (4) sample (5) detector (6) amplifier (7) microcontroller A/D converter

In order to simplify the sensor as well as to reduce its size and cost of manufacturing, narrowband semiconductor light sources were applied. As absorption is measured in a few selected and separated spectral bands, no dispersive nor interferometry device is required to carry out spectral analysis.

Figure 5 shows a block diagram of the developed system. The microcontroller is dedicated to control LED diode and to receive information from optic sensor by the use of analog to digital converter. The second microcontroller transmits information to ZigBee module. The value of hematocrit is send in wireless data transmission format to the host computer. Doctors have the access to the database covered with all patients' blood parameters.

ZigBee technology was design specifically for use in the manufacture of various types of sensors [11,12] and control devices [13] or monitoring [14,15]. In 2003 ratified standard IEEE 802.15.4 is a simple but useful packet protocol, which ensures high reliability, prioritizing communication, spread spectrum transmission and so on. ZigBee device do not require a lot of bandwidth, while delay for the detection and the power consumption is minimized as cost of devices itself.

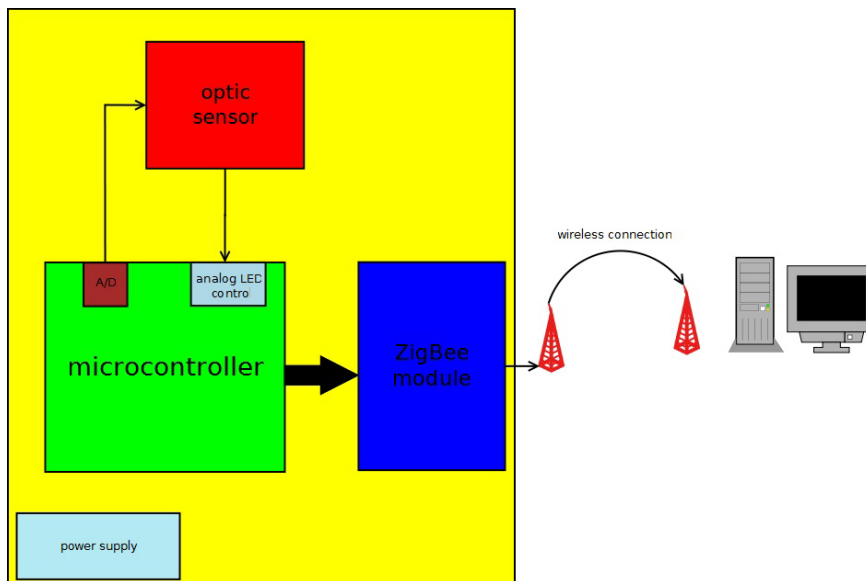

Fig.5. Block diagram of the wireless measurement system

Wireless sensor based on ZigBee module [16] have many advantages like time working on batteries in years, simplicity of using in compared to the Bluetooth technology because have only two modes: active (sending/receiving signal) or sleep and low cost of final sensor. The global implementation of standard IEEE 802.15.4 allows to work in the bands respectively: 868MHz for Europe, 915MHz for USA and Australia and 2,4 GHz band that is allowed in almost whole world.

#### 4. Experimental

In order to find out whether designed sensor sufficient accuracy to monitoring of blood hematocrit, a series of measurements was carried out. As the object of our investigation the whole human blood was used. Set of 2 ml blood samples with various hematocrit levels were provided by the Gdansk Blood Donor Centre (Figure 6). Presented results are based on 120 independent blood samples. Such approach has significant advantage, because we were able to use wide representative group of volunteers. It should be noted that samples were get from rather healthy volunteers and therefore our measurement range of the hematocrit measurement was limited to the value of 30 to 50%. This range was wide enough to find out if resolution of the measurement is sufficient. At this stage we were not measuring blood samples having very extreme HCT values which refers to very sick patients.

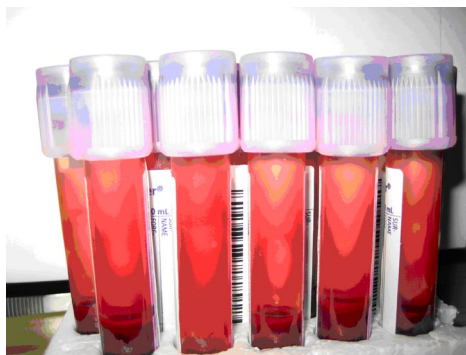

Fig.6. Blood samples used during experiments.

Moreover, the hematocrit level of each blood sample was obtained by standard laboratory clinical diagnostics at the Gdansk Blood Donor Centre as reference measurements, as well

## 5. Measurement results and discussion

Results of investigation are presented in Figures 7, 8 and 9. Figures 7 and 8 present intensity of optical signals recorded in transmission mode for both spectral bands, while Figure 9 shows comparison of results obtained by use of the developed sensor with reference measurement carried out by standard laboratory clinical diagnostics at the Gdansk Blood Donor Centre. Moreover, trend lines with respective coefficients are presented in Figures.

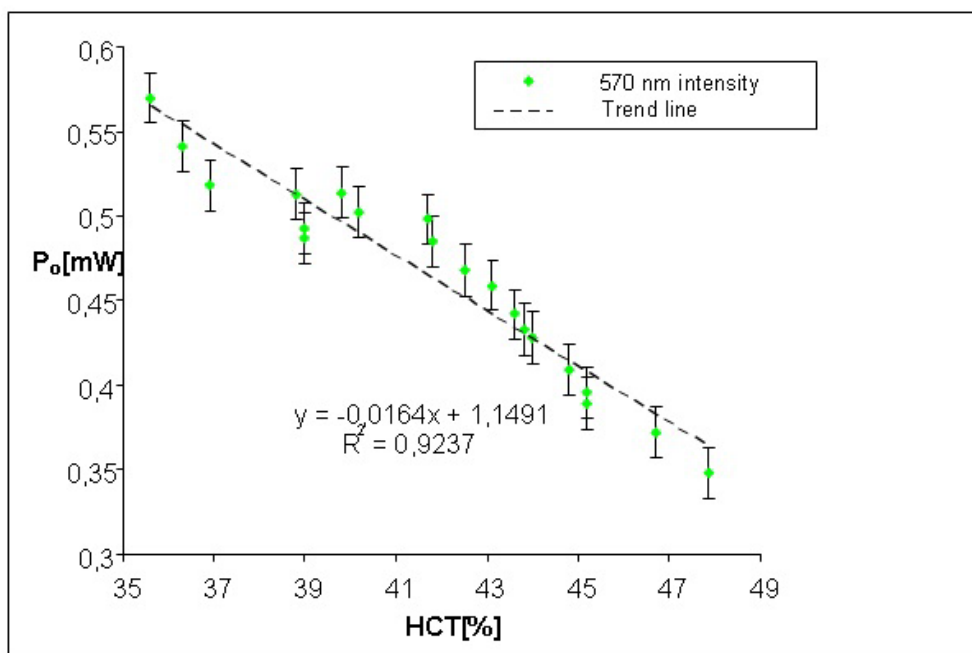

Fig.7. Intensity of the optical signal in band at 570 nm vs. hematocrit level.

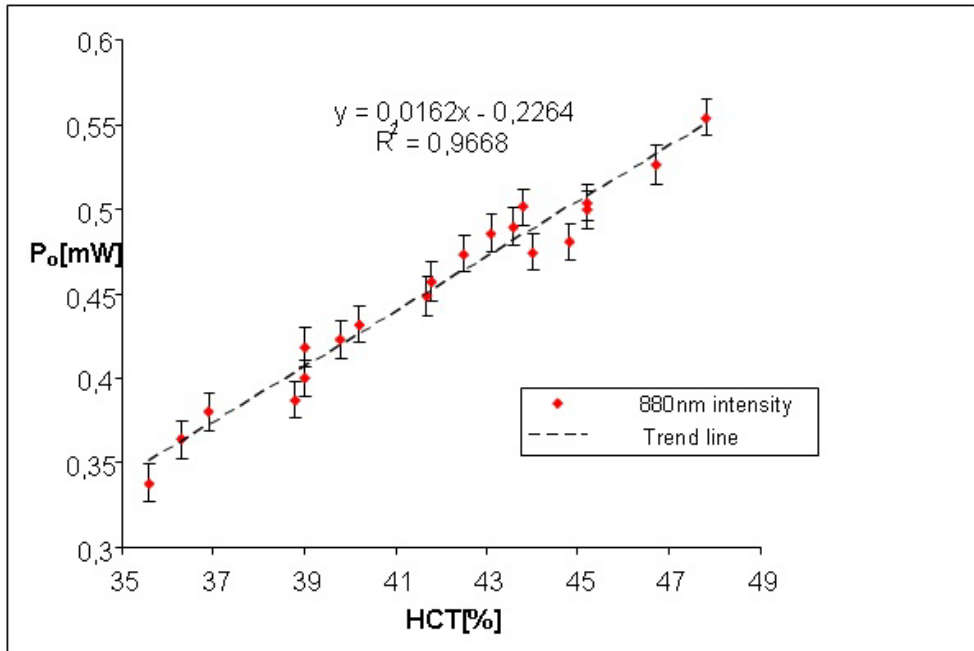

Fig.8. Intensity of the optical signal in band at 880 nm vs. hematocrit level.

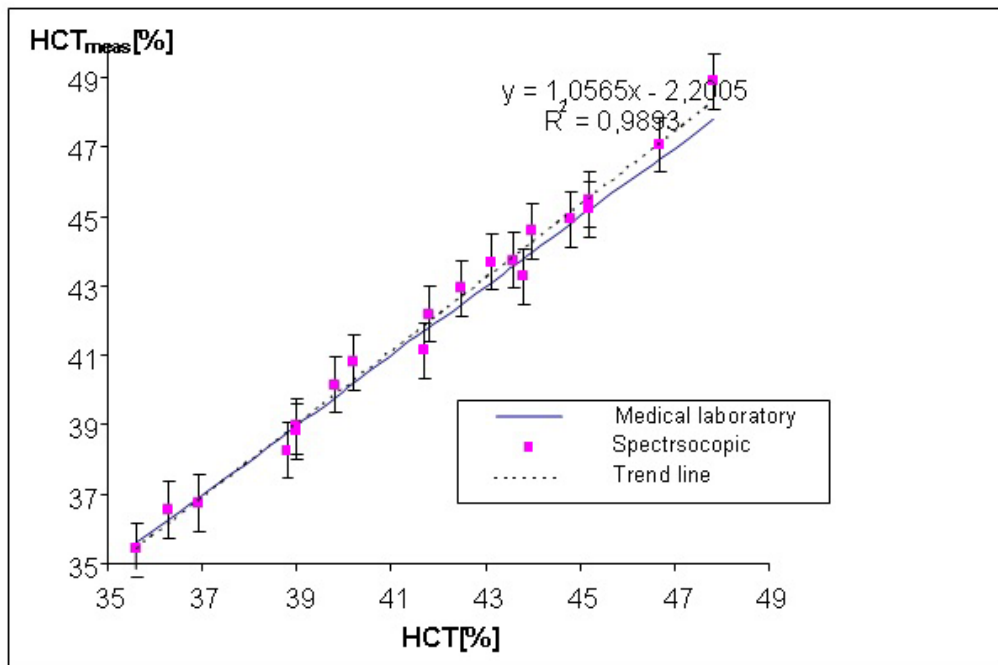

Fig.9. Calibration of the sensor - comparison of results obtained by use of the developed sensor with reference measurement carried out by standard laboratory clinical diagnostics at the Gdansk Blood Donor Centre.

For these characteristics (Figure 7 and 8) trends can be seen from the optical power level vs. hematocrit. Figure 8 shows the changes in the received optical signal of the photodetector for the wavelength 880 nm vs. changes in hematocrit levels in the tested samples. It can be seen that with the increase in the HCT level, the level of the received signal increases, which indicates that the absorption of light to the wavelength decreases. It is the result of a smaller share of water in the sample, which is used to define the reference. However, if the Figure 7 representing the dependence of the received signal level on the detector for 570 nm on the hematocrit level, the signal received at the detector decreases when hematocrit level increases. This is the result of increasing the level of hematocrit and red blood cell concentration in the sample, which is a factor of increasing the absorption.

Measured HCT values deviate from the theoretical values, but only slightly. Analyzing of Figure 9 shows the calculated characteristics of the coefficient of determination, which is  $R^2 = 0.9893$ , which confirms that use of two bands is better than use of single band 570 nm (Figure 7 -  $R^2=0.923$ ). Thus, it can be assumed that in the case of the developed device the obtained relationship is linear. It can be noted from Figure 9 that the measurement system has very good sensitivity. System inaccuracy is less than 1.5%, which is a satisfying result.

## 6. Conclusion

Our motivation was to design the system for measuring human blood parameters of patients, who are sick or elderly and are not able to control this parameter in the ambulatory. The investigation of spectroscopic method confirms its ability for the hematocrit control in appropriate measurement range with sufficient accuracy. The analysis of the preliminary results has showed that the measurement system based on the spectroscopic measurement is the most accurate solution. The designed system is cheap and accurate. Furthermore, it is easy to use what makes it possible to apply this system in practice. The downside of this system is undoubtedly the measurement speed because one measurement takes from 30 to 60 sec. One can increase the speed of the system, reducing the acquisition time, unfortunately, these results in a decrease in accuracy. The presented preliminary results can be the base for building sensor ready for practical applications. Shown HCT level measurement range is the result of blood samples available to test. Attempts were from healthy donors, so it was impossible to measure the wider range, but preliminary results allow to conclude that this measurement is correct and meets the design intent. Moreover, there are no factors that would disable widening of the measurement range.

## Acknowledgements

This study was partially supported by the National Science Center under the grant entitled: "Investigation of the relationship between the spectrum of optical signal and blood properties" as well as DS Programs of the Faculty of Electronics, Telecommunications and Informatics, Gdańsk University of Technology. Authors wish to thank to the Gdansk Blood Donor Centre for providing blood samples and their characterisation by clinical laboratory methods.

## References

- [1] Jędrzejewska-Szczerska M., Gnyba M., Kosmowski B. Low-Coherence Fiber-Optic Interferometric Sensors, *Acta Physica Pol.A* 2011 **4**: 621-24.
- [2] Schmitt J., Guan-Xiong Z., Miller J. Measurement of blood hematocrit by dual-wavelength near-IR photoplethysmography, *Proc. of SPIE* 1992, **1641**:150-161.
- [3] Xu X., Chen Z. Evaluation of hematocrit measurement using spectral domain optical coherence tomography *Proc. Conf. 2008 International Conference on BioMedical Engineering and Informatics Sanya* 2008, 615-8.
- [4] Enejder A., Koo T., Oh J., Hunter M., Sasic S., Feld M. Blood analysis by Raman spectroscopy, *Optics Lett.* 2002 **27**: 2004-6.
- [5] Ifitimia N. et al. Toward noninvasive measurement of blood hematocrit using spectral domain low coherence interferometry and retinal tracking, *Optics Expr.* 2006 **14**: 3377-88.
- [6] Gnyba M. Smulko J., Kwiatkowski A., Wierzba P. Portable Raman spectrometer – design rules and applications, *Bull. Pol. Acad.Sci. Tech. Scien.* 2011, **59(3)**: 325-9.



- [7] Strąkowski M., Pluciński, J., Kosmowski, B. Polarization sensitive optical coherence tomography with spectroscopic analysis, *Acta Physica Pol. A* 2011 **120** (4):785-788
- [8] Jędrzejewska-Szczerska M., Gnyba M. Optical Investigation of Hematocrit Level in Human Blood, *Acta Physica Pol.* 2011 **4**: 642-6.
- [9] Traczyk W. *Fizjologia człowieka w zarysie*. Warszawa Wydawnictwo Lekarskie PZWL; 2007. [in polish]
- [10] J. Schmitt, Z. Guan-Xiong, J. Miler, "Measurement of blood hematocrit by dual-wavelength near-IR photoplethysmography", *proc of SPIE*, Vol. 1641, 1992
- [11] Huircán, J.I., Muñoz, C., Young, H., Von Dossow, L., Bustos, J., Vivallo, G., Toneatti, M., 2010. ZigBee-based wireless sensor network localization for cattle monitoring in grazing fields. *Computers and Electronics in Agriculture* 74, 258–264.
- [12] Lu, K.-Y., 2011. A plug-and-play data gathering system using ZigBee-based sensor network sensor network. *Computers in Industry* 62, 719–728.
- [13] Shu-guang, M., 2011. Construction of Wireless Fire Alarm System Based on ZigBee Technology. *Procedia Engineering* 11, 308–313.
- [14] Valdastrì, P., Rossi, S., Menciasì, A., Lionetti, V., Bernini, F., Recchia, F.A., Dario, P., 2008. An implantable ZigBee ready telemetric platform for in vivo monitoring of physiological parameters. *Sensors and Actuators A: Physical* 142, 369–378.
- [15] Huang, L.-C., Chang, H.-C., Chen, C.-C., Kuo, C.-C., 2011. A ZigBee-based monitoring and protection system for building electrical safety. *Energy and Buildings* 43, 1418–1426.
- [16] P. Kinney, ZigBee Technology: Wireless Control that Simply Works, *Communications Design Conference*, October 2003

## Vitae

**Małgorzata Jędrzejewska-Szczerska** received her Ph.D. Degree with honours in Electronics from the Gdańsk University of Technology in 2008. Currently she is an assistant professor in the Department of Metrology and Optoelectronics. Her area of interest includes use of white-light interferometry, fiber-optic technology and application of optical measurements in biomedicine.

**Ernest Krystian** received the MSc degree in Electronics from the Gdańsk University of Technology, Poland, in 2009. Currently he is a PhD student at Gdańsk University of Technology on Faculty of Electronics. His research interests lie in boron doped diamond and optics sensors.

**Marcin Gnyba** (b. 1972) received his Ph.D. Degree with honours in Electronics from the Gdańsk University of Technology in 2006. Currently he is an assistant professor in the Department of Metrology and Optoelectronics. His area of interest includes use of Raman spectroscopy in manufacturing processes as well as in environmental and biochemical nanosensors.

**Michał Sobaszek** was born in Gdańsk, Poland in 1984. He received the MSc degree in Materials Engineering from the Gdańsk University of Technology, Poland, in 2009. Currently he is a PhD student at Gdańsk University of Technology on Faculty of Electronics. His research interests lie in boron doped diamond and optics sensors.

