

Bartosz BASTIAN\* Michał WASILCZUK\*

## THE USE OF PLATE SPRINGS FOR PRELOADING OF A SYSTEM OF TAPERED ROLLER BEARINGS OF A WIND TURBINE GEARBOX

### WYKORZYSTANIE SPRĘŻYN TALERZOWYCH DO UZYSKANIA NAPIĘCIA WSTĘPNEGO ZESPOŁU ŁOŻYSK STOŻKOWYCH WAŁU PRZEKŁADNI TURBINY WIATROWEJ

**Key words:**

wind turbine gearbox, taper roller bearings, preload, bearing durability, spring plates.

**Abstract**

The use of preloaded tapered roller bearings in wind turbine drive systems allows a transfer of load in the case of high variations of axial forces. The examined bearing system, a modification of a current design, consists of a pair of different sized bearings. Previous study showed the high sensitivity of tapered roller bearings on the existing radial interference. Dimensional tolerances used in the original design do not allow obtaining precise values of preload required for slippage-free operation of bearings with varying wind turbine load conditions. With the aim of achieving expected preload values, the use of plate springs (Belleville springs) is proposed. The springs will allow creating an axial force, independently of real dimensions in a modernised unit. Furthermore, it is very important in the case of gearbox retrofits to be executed up in the wind turbine nacelle without dismantling the gearbox.

**Słowa kluczowe:**

przekładnia turbiny wiatrowej, łożyska stożkowe, napięcie wstępne, trwałość łożysk, sprężyny talerzowe.

**Streszczenie**

Układ napędowy turbiny wiatrowej przy wykorzystaniu łożysk stożkowych napiętych wstępnie pozwala na przeniesienie napędu z wysokim stosunkiem siły obwodowej do siły promieniowej. Badany układ łożysk składa się z pary dwóch łożysk o różnych wymiarach. Układ taki powoduje trudności obliczeniowe polegające na braku metod obliczeniowych takich układów oraz brak możliwości zapewnienia prawidłowych wartości napięcia wstępnego przy zastosowaniu komercyjnie dostępnych łożysk. W celu osiągnięcia prawidłowych wartości napięcia wstępnego proponowane jest zastosowanie sprężyn talerzowych, które pozwalałyby na generowanie określonej siły osiowej, uniezależniając układ od istniejących warunków wymiarowych. Jest to istotne, ponieważ umożliwia modernizację przekładni w gondoli turbiny wiatrowej bez konieczności kosztownego demontażu przekładni.

## INTRODUCTION

Among renewable energy sources in Poland, wind farms have been the fastest expanding sector with highest capacity. Between 2005 and 2016, wind power had almost 70-fold increase, with 69% capacity of renewable energy sources in Poland at the end of 2016 [L. 1]. The damage of wind turbine gearboxes is one of the most significant failures occurring in wind turbines. This type of failures, as shown in Fig. 1, constitutes the highest

downtime of wind turbines. According to the summary of the wind turbine gearbox failures (Fig. 2), damage of high speed shaft bearings are the most common [L. 2].

The authors of this paper were involved in an analysis of the causes of premature failures of gearboxes in one particular type of a wind turbine gearbox. The analysis presented in [L. 3] showed that the failures were occurring most frequently in the high speed shaft bearings of the gearbox, which was consistent with the worldwide gathered data [L. 2]. The original bearing

\* Gdańsk University of Technology, Faculty of Mechanical Engineering, ul. Narutowicza 11/12, 80-233 Gdańsk, Poland, e-mail: barbasti@pg.gda.pl, e-mail: mwasilcz@pg.gda.pl.

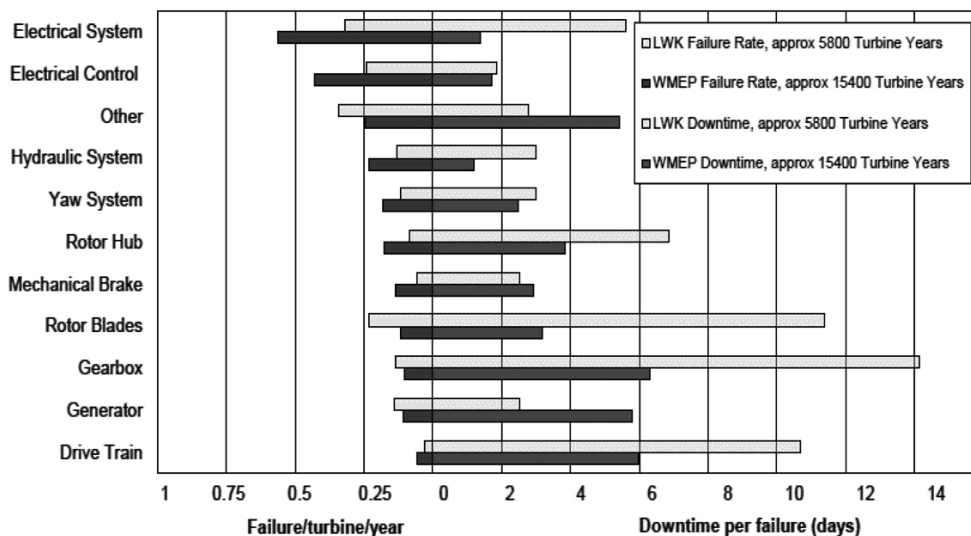

Fig. 1. Failure rate and downtime of specific systems [L. 1]

Rys. 1. Częstość uszkodzeń oraz przestoje spowodowane przez awarie poszczególnych podzespołów [L. 1]

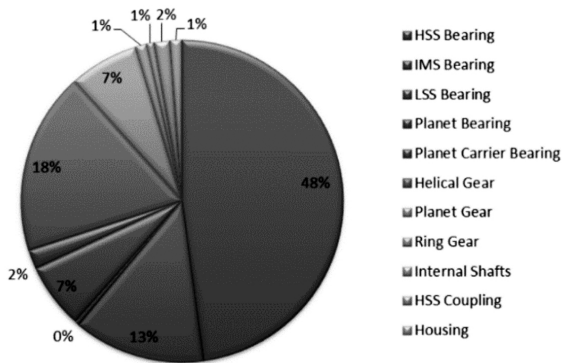

Fig. 2. Wind turbine gearbox failures, divided according to the component [L. 2]

Rys. 2. Udział uszkodzeń poszczególnych elementów przekładni w ogólnej liczbie awarii [L. 2]

system was composed of cylindrical roller bearings and four point contact bearings (QJ type) to accommodate axial load. A detailed study showed that, at certain operating conditions, namely, low load occurring at low wind speeds, the bearings might have experienced slippage of the rolling elements. Slippage of the rolling elements is considered as one of the possible root causes of the high failure rate of high speed bearings of wind turbine gearboxes [L. 4]. The proposed solution of the existing problem in the wind turbine analysed by authors was a system of two preloaded tapered roller bearings [L. 5]. In the calculations, the influence of the preload applied in the system was observed. For the system of the high speed shaft of the 1.5 MW wind turbine, the optimal preload was established at range

between 9–22 kN. For these values, rolling elements should not be prone to sliding, and the expected lifetime of the bearing system is not lower than the lifetime of other components of the gearbox. In the previously designed system, the preload was applied by the radial interference between the shaft and the inner bearing rings (Fig. 3). Initial axial clearance between the oil feed ring and outer bearing rings prevents the system from excessive preload. However, this design was found not to be precise enough due to existing radial tolerances of shaft and bearing bore. In this case, the individual pair of bearing and shaft could have the following conditions:

- Underloaded, thus allowing sliding of the rolling elements;
- Loaded properly; or,
- Overloaded with the preload being a dominant load, resulting in rapid failure of the bearing system [L. 6].

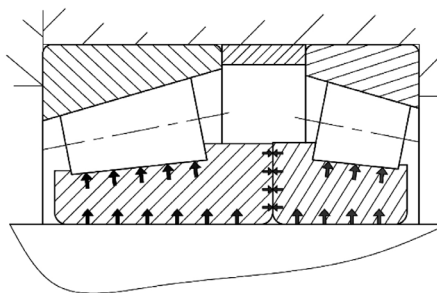

Fig. 3. The mechanism of preload generation, based on interference between the bearing and the shaft [L. 3]

Rys. 3. Sposób wywierania napięcia wstępnego poprzez wcisk pomiędzy wałem a pierścieniem łożyska [L. 3]

Figure 4 shows qualitatively the relations of bearing lifetime based on fatigue calculation as a function of the existing clearance [L. 7]. The right-hand side of the graph presents insufficient preload (allowing for bearing clearance), when not all of the rolling elements are

engaged with the raceways, making them susceptible to sliding. In such a case, the fatigue mode of failures may not be dominating. On the left-hand side, the case of increased preload is presented. The increase of preload results in a substantial decrease in lifetime.

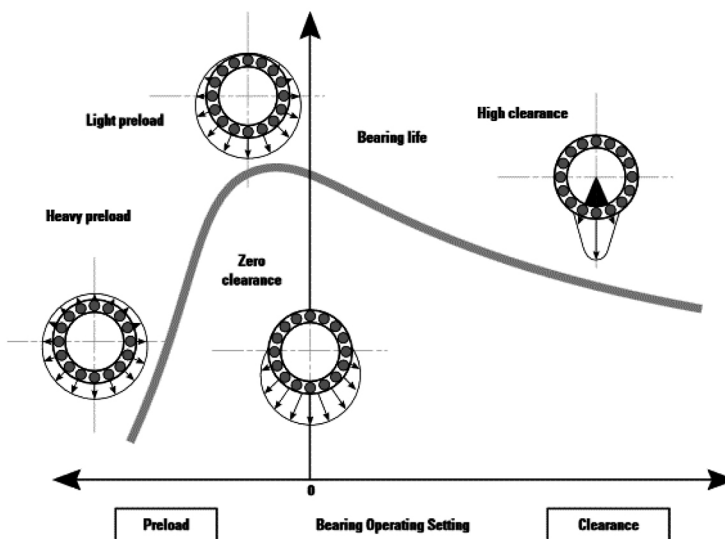

Fig. 4. Bearing life vs. bearing operating setting [L. 7]

Rys. 4. Trwałość łożyska w zależności od istniejącego luzu [L. 7]

PROPOSED SYSTEM MODERNIZATION

In order to minimize the influence of existing tolerances, a different type of preload mechanism is proposed. Instead of geometrical pre-load obtained by a defined interference, a force-type pre-load system with the use

of springs was designed with an idea similar to the one presented in the patent PL 224 665 (8). The concept of the system is presented in Fig. 5. Pre-tensioned sets of plate springs are used in the bearing system. The springs are pressed by the gearbox cover to the bearing sleeve. The bearings outer rings are freely compressed by the

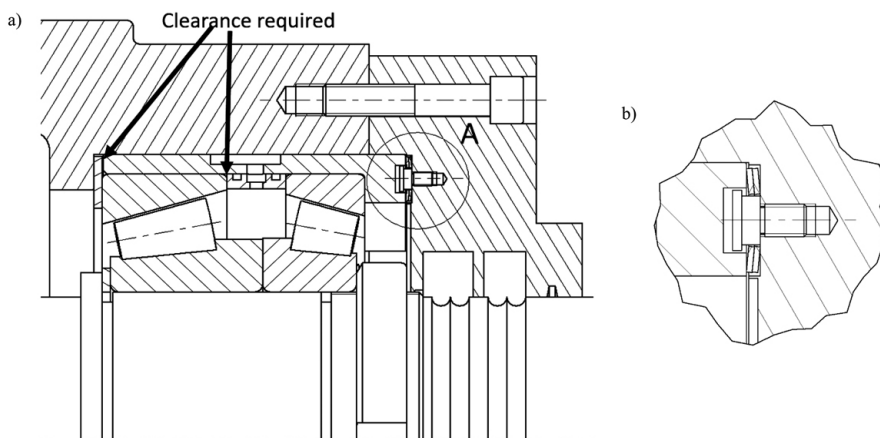

Fig. 5. The scheme of the plate spring-based system: a) cross section of the locating bearing system, b) magnification of the disk spring preload

Rys. 5. Konstrukcja węzła łożyskowego z napięciem wstępnym generowanym przez sprężynę: a) przekrój przez układ łożysk ustalających, b) powiększenie układu napięcia wstępnego

sleeve. Dimensions are designed in such a way that, after assembly, the clearance remains between the bearing sleeve and the left-hand side washer and between the oil feed ring and outer bearing rings, as marked in **Fig. 5**. Compression of the springs generates the bearings preload, and the selection of the springs arrangements must provide a desired level of the preload force and an adequate range of spring deflection.

## THE SELECTION OF PLATE SPRING SET

The presented system allows the assembly of many spring configurations. Spring sets can be spread around the axis of the shaft, and an individual set can consist of parallel and serial stacks, for the multiplication of deflection and force range (**Fig. 6**).

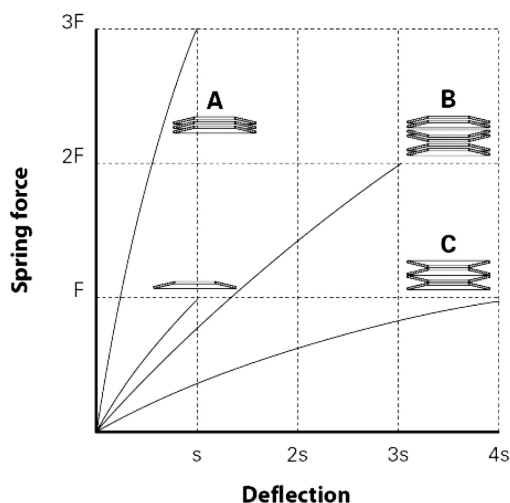

**Fig. 6. Springs assembled in parallel and serial sets [L. 9]**  
Rys. 6. Charakterystyki sprężyn w zespołach równoległych i szeregowych [L. 9]

The characteristic of the spring is dependent on the ratio  $h_0/t$  ( $h_0$  – the cup height, maximal deflection of spring,  $t$  – thickness of spring material). As presented in **Fig. 7**, the characteristic for the theoretical ratio equal to 0 is linear, and with the increase of the ratio, it becomes more degressive.

Previously determined values of preload should be supplemented with the required deflection range. The deflection differs based on the existing interference between the bearing and the shaft. The higher values of the interference will cause a higher separation of outer rings of bearings and higher deflection of the spring. For all possible values of interference, the condition of amount of preload must be fulfilled.

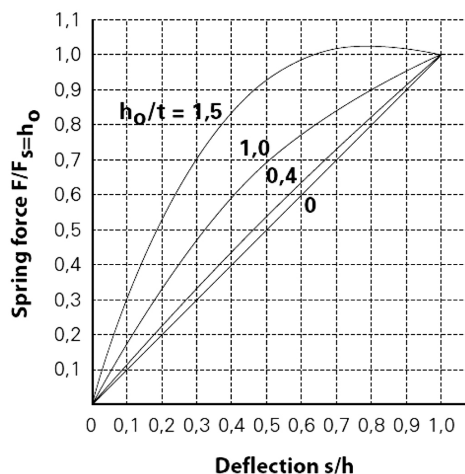

**Fig. 7. Plate spring characteristic for different ratios of max. deflection to spring material thickness [L. 9]**

Rys. 7. Charakterystyka sprężyny talerzowej w zależności od istniejącej zależności maksymalnego ugięcia do grubości materiału sprężyny [L. 9]

Expected bearing bore tolerance and the tolerance of the shaft ( $k_5$ ) adequate for light loading (C/P ratio larger than 10) determines the allowable range of interference at 3–46  $\mu\text{m}$  range. The interference causes radial deformation of  $\Delta d = 0.8 U$ , with,  $U$  – existing interference.

The radial deformation will increase the distance between the bearings. The ratio between the axial shift and radial deformation is the same as ratio between the axial ( $s_a$ ) and radial clearance ( $s_r$ ).

$$\frac{s_a}{s_r} = 4.6 \cdot Y_0 \quad (1)$$

The values of  $Y_0$  are specific to the bearing based on the bearing working angle, and, for both bearings in this case, the value is equal to 1.38. Therefore, the axial movement of the outer rings is equal to the following:

$$S_a = 2 \cdot 4.6 \cdot Y_0 \cdot 0.8 \cdot U \quad (2)$$

The theoretical interference allows the estimation of the deflection between 31 to 467  $\mu\text{m}$ . Therefore, the range in which the spring exerts a desired load should be at least 436  $\mu\text{m}$ .

Examples of characteristics of various cases of spring arrangements are presented in **Fig. 8**. The first set consists of 3 sets mounted along the circumference of each set composed of 2 serial springs ( $23 \times 12.2 \times 1.5$  mm). The second set is composed of 4 circumferential sets of thinner springs ( $23 \times 12.2 \times 1.25$  mm) in 2 serial stacks of 2 parallel springs. The third set consists of the same springs as in the first case; however, the number of

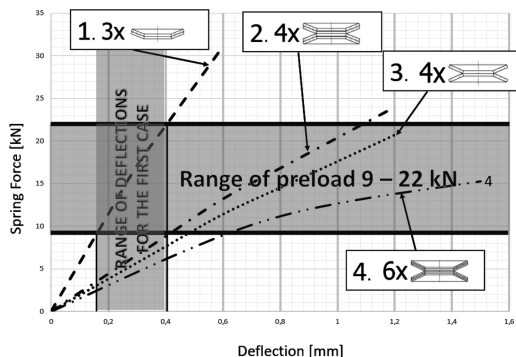

**Fig. 8. Characteristics of chosen spring sets**  
 Rys. 8. Charakterystyki wybranych zespołów sprężyn

circumferential sets was changed to 4 and the stack setup was changed from serial to parallel. The last presented case is an assembly of 6 circumferential sets consisting of 2 parallel stacks of 3 springs each (36 springs in total).

In Fig. 8, the acceptable range (9–22 kN) is marked (grey horizontal zone). For all spring setups, two characteristic values of deflection can be read:  $\Delta d_{9\text{kN}}$  and  $\Delta d_{22\text{kN}}$ . The values can be read out as the value of deflection, respectively, at 9 kN and 22 kN preload. Not all springs have a range of force reaching to the higher threshold. For this case,  $\Delta d_{22\text{kN}}$  is assumed to be equal to the maximal value of deflection for the set. Difference  $\Delta d_{22\text{kN}} - \Delta d_{9\text{kN}}$  is the range of spring deflection in which the bearings should have a proper value of preload (the range  $\Delta d_{22\text{kN}} - \Delta d_{9\text{kN}}$  for the first case is marked as a shaded vertical band on the plot). A summary of these cases is presented in Table 1.

**Table 1. Spring sets summary**  
 Tabela 1. Podsumowanie wyników

Set No	Single spring dimension	$h_0 / t$	$h_0$ [mm] of single spring	$F_{\text{max}}$ [N] of a single spring	$h_0$ [mm] of spring set	$F_{\text{max}}$ [kN] of spring set	$\Delta d_{22\text{kN}} - \Delta d_{9\text{kN}}$ [mm]	Number of springs in a set
1	$23 \times 12.2 \times 1.5$	0.4	0.6	5184	0.6	31.1	0.24	$3 \times 2$
2	$23 \times 12.2 \times 1.25$	0.48	0.6	3000	1.2	24	0.64	$4 \times 4$
3	$23 \times 12.2 \times 1.5$	0.4	0.6	5184	1.2	20.7	0.7	$4 \times 2$
4	$23 \times 12.2 \times 0.9$	0.83	0.75	1273	1.5	15.3	0.9	$6 \times 6$

The first set has insufficient range of deflection, i.e. the stiffness of the set is too high for the application, not allowing for the proper preload value at extreme values of interference. Other cases [L. 2–4] have sufficient deflection. Case 4 has a largest range in which the preload is obtained. The set is composed of the most flexible springs, with the highest  $h_0/t$  ratio. In the graph, it is possible to observe that degressive characteristic obtained with this set is most preferable (long range with small difference of generated force).

**CONCLUSIONS**

The high sensitivity of the bearing system on dimension tolerances can be resolved with a more flexible system of plate springs. The proposed system allows for choice from multiple versions, where the lifetime of bearings is not the only deciding factor. Although the range of generated loads and operational range of deflections is the most important criteria, the number of sets distributed around the housing circumference may also be important, because of possible collisions with the holes placed on the bearing housing cover. Because of this, Sets 2 or 3 seem to be a better solution than Set 4.

**REFERENCES**

1. The state of Wind Energy in Poland in 2016, The Polish Wind Energy Association, 2017.
2. Sheng S.: Report on Wind Turbine Subsystem Reliability – A survey of Various Databases, NERL, 2013.
3. Wasilczuk M., Gawarkiewicz R., Libera M., Wasilczuk F., Kinal G.: Bearing systems of wind turbines – maintenance problems (in Polish). Tribologia 4/2015: 187–198 10/2015.

4. Marks C.S., Matthew B.T.: Bearing selection techniques as applied to mainshaft direct and hybrid drives for wind turbines, Timken Technical Paper, 2009.
5. Bastian B., Gawarkiewicz R., Wasilczuk M.: Analysis of the possibilities of high speed shaft bearing system durability increase. Tribologia 3/2016, p. 037–047.
6. Bastian B., Gawarkiewicz R., Wasilczuk M.: The influence of housing arrangement and interference on preload and theoretical lifetime of a system of taper roller bearings of a high speed shaft of a wind turbine gearbox. Tribologia 4/2017: 21–26.
7. <http://www.timken.com/ja-jp/products/maintdiag/Documents/5892-Timken-Bearing-Damage-Analysis-with-Lubrication-Reference-Guide.pdf>, Timken bearing damage analysis with lubrication reference guide, 2015.
8. Olszewski A., Wiszniewski M.: Ułożyskowanie głównego wału turbiny wodnej. Patent PL 224 665.
9. [http://www.lesjoforsab.com/standard-springs/120-130\\_en\\_id983.pdf](http://www.lesjoforsab.com/standard-springs/120-130_en_id983.pdf) - Disc springs design parameters.